



PRO Series Live Audio Systems

Owner's Manual





PRO Series Live Audio Systems Owner's Manual

Midas Klark Teknik Limited,
Klark Industrial Park,
Walter Nash Road,
Kidderminster.
Worcestershire.
DY11 7HJ.
England.

Tel: +44 1562 741515
Fax: +44 1562 745371

Email: info@midasklarktechnik.com
Website: www.midasconsoles.com

PRO Series Live Audio Systems — Owner's Manual
DOC02-PROSERIES Issue A — September 2010
© Red Chip Company Ltd.

In line with the company's policy of continual improvement, specifications and function may be subject to change without notice. This Owner's Manual was correct at the time of writing. E&OE.



IMPORTANT SAFETY INSTRUCTIONS



The lightning flash with arrowhead symbol within an equilateral triangle is intended to alert the user to the presence of uninsulated “dangerous voltage” within the product's enclosure that may be of sufficient magnitude to constitute a risk of electric shock to persons.



The exclamation point within an equilateral triangle is intended to alert the user to the presence of important operating and maintenance (servicing) instructions in the literature accompanying the product.

- 1 Read these instructions.
- 2 Keep these instructions.
- 3 Heed all warnings.
- 4 Follow all instructions.
- 5 Do not use this apparatus near water.
- 6 Clean only with a dry cloth.
- 7 Do not block any of the ventilation openings. Install in accordance with the manufacturer's instructions.
- 8 Do not install near any heat sources such as radiators, heat registers, stoves, or other apparatus (including amplifiers) that produce heat.
- 9 Do not defeat the safety purpose of the polarized or grounding-type plug. A polarized plug has two blades with one wider than the other. A grounding type plug has two blades and a third grounding prong. The wide blade or the third prong are provided for your safety. If the provided plug does not fit into your outlet, consult an electrician for replacement of the obsolete outlet.
- 10 Protect the power cord from being walked on or pinched particularly at plugs, convenience receptacles and the point where they exit from the apparatus.
- 11 Only use attachments/accessories specified by the manufacturer.
- 12 Use only with the cart, stand, tripod, bracket, or table specified by the manufacturer, or sold with the apparatus. When a cart is used, use caution when moving the cart/apparatus combination to avoid injury from tip-over. 
- 13 Unplug this apparatus during lightning storms or when unused for long periods of time.
- 14 Refer all servicing to qualified personnel. Servicing is required when the apparatus has been damaged in any way, such as power-supply cord or plug is damaged, liquid has been spilled or objects have fallen into the apparatus, the apparatus has been exposed to rain or moisture, does not operate normally, or has been dropped.
- 15 Use the mains plug to disconnect the apparatus from the mains.
- 16 **Warning: To reduce the risk of fire or electric shock, do not expose this apparatus to rain or moisture.**
- 17 **Warning: Do not expose this equipment to dripping or splashing and ensure that no objects filled with liquids, such as vases, are placed on the equipment.**
- 18 **Warning: The mains plug of the power supply cord shall remain readily operable.**

INSTRUCTIONS DE SÉCURITÉ IMPORTANTES



Le symbole représentant un éclair fléché dans un triangle équilatéral a pour but d'alerter l'utilisateur de la présence d'une "tension dangereuse" non isolée à l'intérieur du boîtier, pouvant être d'une force suffisante pour constituer un risque d'électrocution.



Le point d'exclamation dans un triangle équilatéral a pour but d'alerter l'utilisateur de la présence d'instructions importantes concernant le fonctionnement et la maintenance, dans la documentation qui accompagne l'appareil.

- 1 Veuillez lire ces instructions.
- 2 Conservez ces instructions.
- 3 Respectez toutes les consignes de sécurité.
- 4 Suivez scrupuleusement toutes les instructions.
- 5 N'utilisez pas cet appareil près d'un point d'eau.
- 6 Utilisez uniquement un chiffon sec pour le nettoyer.
- 7 N'obstruez aucune des ouïes de ventilation. Installez-le en respectant les instructions du fabricant.
- 8 Ne l'installez pas près de sources de chaleur tels que radiateurs, panneaux chauffants, étuves, ou autres appareils produisant de la chaleur (dont les amplificateurs).
- 9 Ne pas utiliser d'adaptateur pour supprimer la prise de terre des prises à trois fiches. Si la prise fournie ne peut pas être branchée dans la prise électrique, adressez-vous à un électricien qui remplacera la prise obsolète.
- 10 Protégez le cordon secteur afin que l'on ne marche pas dessus et qu'il ne soit pas pincé, surtout au niveau des prises, ou à l'endroit où il sort de l'appareil.
- 11 Utilisez exclusivement des fixations et des accessoires recommandés par le fabricant.
- 12 Utilisez l'appareil uniquement avec le chariot, le trépied, le support ou la table spécifiés par le fabricant, ou vendus avec l'appareil. Si un chariot est utilisé, prenez toutes les précautions nécessaires lorsque vous devez déplacer l'ensemble (chariot et appareil) afin qu'ils ne se renversent pas. 
- 13 Débranchez l'appareil en période d'orage ou s'il doit rester inutilisé pendant longtemps.
- 14 Confiez toutes les réparations et interventions à un personnel qualifié. Une intervention est nécessaire si l'appareil a été endommagé d'une façon ou d'une autre, si son cordon ou sa prise secteur ont été endommagés, si du liquide a été renversé ou si des objets sont tombés à l'intérieur, ou encore si l'appareil a été exposé à la pluie ou à l'humidité, s'il ne fonctionne pas normalement, ou s'il est tombé.
- 15 Débrancher l'appareil du réseau électrique par la prise de secteur.
- 16 **Avertissement : afin de réduire le risque d'incendie ou de choc électrique, ne pas exposer cet appareil à la pluie ou à de l'humidité.**
- 17 **Avertissement : n'exposez pas cet équipement aux éclaboussures et veillez à ce qu'aucun récipient rempli de liquide, verre ou vase, ne soit posé dessus.**
- 18 **Avertissement : la prise secteur doit toujours rester directement accessible.**



EC-Declaration of Conformity

The undersigned, representing the following manufacturer

Manufacturer:

Midas Klark Teknik Ltd.

Address:

Klark Industrial Park, Walter Nash Road,
Kidderminster. Worcestershire. DY11 7HJ.

hereby declares that the following product

Product Type Number	Product Description	Nominal Voltage(s)	Current	Freq.
PRO3	Control Centre	115V AC 230V AC	2.9A 1.5A	50/60Hz

is in conformity with the regulations of the following marked EC-directives and bears the CE-mark accordingly

reference number	title
2004/108/EC	EMC Directive (EMC)
2006/95/EC	Low-Voltage Directive (LVD)

The conformity of the product with EC Directives for use in environment E4 is provided by compliance with the following standards:

Standards/date:

Applied Electrical Safety test standards:

reference number	title
EN 60065:2002	Audio, video and similar electronic apparatus. Safety requirements.

Applied EMC emission test standards:

ref. no.	title
EN 55103-1:1996 Class A	EN 55103-1 Annex A: Radiated magnetic disturbance, 50Hz-50kHz CISPR 22: Radiated disturbance, 30-1000MHz CISPR 22: Conducted disturbance, ac & signal ports CISPR 16: Discontinuous disturbance EN 61000-3-2:2000 Mains harmonics EN 61000-3-3:1995 Mains voltage flicker

Applied EMC immunity test standards:

ref. no.	title
EN 55103-2:1996 Class A	EN 61000-4-2:1995 Electrostatic discharge EN 61000-4-3:1996: Radiated RF disturbance, 80-1000MHz EN 55103-2 Annex A: Magnetic LF disturbance, 50Hz-10kHz EN 61000-4-4:1995: Fast transient bursts, ac & signal ports EN 61000-4-5:1995: Surge, ac port EN 61000-4-6:1996: Conducted RF field, ac & signal ports EN 61000-4-11:1994: Mains voltage dips and interruptions

Place, date: Kidderminster, UK
18th August 2010



General Manager
Printed name: John Oakley



AVP, Product Development
Printed name: Alex Cooper



EC-Declaration of Conformity

The undersigned, representing the following manufacturer

Manufacturer:

Midas Klark Teknik Ltd.

Address:

Klark Industrial Park, Walter Nash Road,
Kidderminster. Worcestershire. DY11 7HJ.

hereby declares that the following product

Product Type Number	Product Description	Nominal Voltage(s)	Current	Freq.
PRO6	Control Centre	115V AC 230V AC	2.9A 1.5A	50/60Hz

is in conformity with the regulations of the following marked EC-directives and bears the CE-mark accordingly

reference number	title
2004/108/EC	EMC Directive (EMC)
2006/95/EC	Low-Voltage Directive (LVD)

The conformity of the product with EC Directives for use in environment E4 is provided by compliance with the following standards:

Standards/date:

Applied Electrical Safety test standards:

reference number	title
EN 60065:2002	Audio, video and similar electronic apparatus. Safety requirements.

Applied EMC emission test standards:

ref. no.	title
EN 55103-1:1996 Class A	EN 55103-1 Annex A: Radiated magnetic disturbance, 50Hz-50kHz CISPR 22: Radiated disturbance, 30-1000MHz CISPR 22: Conducted disturbance, ac & signal ports CISPR 16: Discontinuous disturbance EN 61000-3-2:2000 Mains harmonics EN 61000-3-3:1995 Mains voltage flicker

Applied EMC immunity test standards:

ref. no.	title
EN 55103-2:1996 Class A	EN 61000-4-2:1995 Electrostatic discharge EN 61000-4-3:1996: Radiated RF disturbance, 80-1000MHz EN 55103-2 Annex A: Magnetic LF disturbance, 50Hz-10kHz EN 61000-4-4:1995: Fast transient bursts, ac & signal ports EN 61000-4-5:1995: Surge, ac port EN 61000-4-6:1996: Conducted RF field, ac & signal ports EN 61000-4-11:1994: Mains voltage dips and interruptions

Place, date: Kidderminster, UK
14th June 2010



General Manager
Printed name: John Oakley



AVP, Product Development
Printed name: Alex Cooper



EC-Declaration of Conformity

The undersigned, representing the following manufacturer

Manufacturer:

Midas Klark Teknik Ltd.

Address:

Klark Industrial Park, Walter Nash Road,
Kidderminster. Worcestershire. DY11 7HJ.

hereby declares that the following product

Product Type Number	Product Description	Nominal Voltage(s)	Current	Freq.
PRO9	Control Centre	115V AC 230V AC	2.9A 1.5A	50/60Hz

is in conformity with the regulations of the following marked EC-directives and bears the CE-mark accordingly

reference number	title
2004/108/EC	EMC Directive (EMC)
2006/95/EC	Low-Voltage Directive (LVD)

The conformity of the product with EC Directives for use in environment E4 is provided by compliance with the following standards:

Standards/date:

Applied Electrical Safety test standards:

reference number	title
EN 60065:2002	Audio, video and similar electronic apparatus. Safety requirements.

Applied EMC emission test standards:

ref. no.	title
EN 55103-1:1996 Class A	EN 55103-1 Annex A: Radiated magnetic disturbance, 50Hz-50kHz CISPR 22: Radiated disturbance, 30-1000MHz CISPR 22: Conducted disturbance, ac & signal ports CISPR 16: Discontinuous disturbance EN 61000-3-2:2000 Mains harmonics EN 61000-3-3:1995 Mains voltage flicker

Applied EMC immunity test standards:

ref. no.	title
EN 55103-2:1996 Class A	EN 61000-4-2:1995 Electrostatic discharge EN 61000-4-3:1996: Radiated RF disturbance, 80-1000MHz EN 55103-2 Annex A: Magnetic LF disturbance, 50Hz-10kHz EN 61000-4-4:1995: Fast transient bursts, ac & signal ports EN 61000-4-5:1995: Surge, ac port EN 61000-4-6:1996: Conducted RF field, ac & signal ports EN 61000-4-11:1994: Mains voltage dips and interruptions

Place, date: Kidderminster, UK
18th August 2010



General Manager
Printed name: John Oakley



AVP, Product Development
Printed name: Alex Cooper

Licences

The following are the license agreements applicable to the Midas Digital Equipment.

End-User Licence Agreement for Midas™ and Klark Teknik™ Software

IMPORTANT - Please read this document carefully before using this Midas™ or Klark Teknik™ Product. This is an agreement governing your use of software or other machine instructions already installed on this Midas™ or Klark Teknik™ Product, as well as other software that we provide for installation on this Product. The Midas™ or Klark Teknik™ Product will not operate in accordance with its documentation without this software.

THIS AGREEMENT ("AGREEMENT" OR "LICENCE") STATES THE TERMS AND CONDITIONS UPON WHICH MIDAS KLARK TEKNIK LIMITED ("COMPANY") OFFERS TO LICENSE THE INSTALLED FIRMWARE, SOFTWARE AND/OR PROGRAMS ("the SOFTWARE") WITH THE MIDAS™ OR KLARK TEKNIK™ CONSOLE OR SIGNAL PROCESSING PRODUCT ("PRODUCT") IN WHICH IT HAS BEEN INSTALLED BY, OR FOR WHICH IT IS PROVIDED BY, THE COMPANY. BY USING THIS PRODUCT YOU WILL BE AGREEING TO BECOME BOUND BY THE TERMS OF THIS LICENCE. IF YOU DO NOT AGREE TO THE TERMS OF THIS LICENCE, DO NOT USE THIS PRODUCT AND PROMPTLY RETURN THE PRODUCT TO THE PLACE WHERE YOU OBTAINED IT FOR A FULL REFUND. You agree to notify any persons whom you permit to operate this Product of the terms of this Licence, and to require them to comply with these terms.

The Software is licensed, not sold, to you for use only under the terms of this Licence, and the Company reserves all rights not expressly granted to you. The Company retains ownership of all copies of the Software itself, and all proprietary parts of it, including those stored on or in the Product.

1. **Licence:** Subject to the terms and conditions of this agreement, the Company grants you, and other persons you permit to operate the Product, a personal, limited, non-exclusive, non-transferable licence to use the Software only on the single Product unit in which it has been installed.
2. **Restrictions:** (a) The Software, and the accompanying written materials, are copyrighted and contain trade secrets and other proprietary matter, including confidential information relating to the specifications and performance characteristics of this Product. Save for such elements as may be licensed to the Company, as described in paragraph 5, all rights to copyrights, trade marks and trade secrets in the Software, or any modifications to it, are owned by the Company. Unauthorised use or copying of the Company's proprietary Software, or any portion thereof, or copying of those written materials, is prohibited. (b) You may not create, market, distribute, or transfer copies of the Company's proprietary Software, or any part of it, to others, or duplicate, rent, lease or loan that Software, or any part of it, except that you may transfer that Software installed in this Product in conjunction with the sale, transfer, loan, rent or lease of this Product, and subject at all times to this Licence. YOU MAY NOT REVERSE ENGINEER, DECOMPILE, DISASSEMBLE, EXTRACT OR SEPARATE OUT, MODIFY, ADAPT, PORT, OR TRANSLATE THE SOFTWARE, DERIVE THE SOURCE CODE OF THE SOFTWARE OR CREATE DERIVATIVE WORKS BASED ON THE SOFTWARE OR ANY ACCOMPANYING WRITTEN MATERIALS, save as is allowed by licences pertaining to component parts of the Software which are licensed by third parties, as described under paragraph 5, or otherwise by law. (c) In the event you violate any term of this Licence, all rights granted herein will automatically and immediately terminate and you must stop using the Software and destroy any copies of the Software.
3. **Limited Warranty:** Subject to your installation of any Software updates issued by the Company as described herein, and the condition below, the Company warrants that the Software will operate in compliance with the Software's material specifications and documentation for a period of 90 days from your purchase of this Product. The Software is provided "as is" and the Company does not warrant that the operation of the Software will meet your requirements or operate free from error. To the greatest extent permissible by law, the Company DISCLAIMS ALL WARRANTIES AND CONDITIONS, EITHER EXPRESS OR IMPLIED, INCLUDING THE WARRANTIES OF MERCHANTABILITY, FITNESS FOR A PARTICULAR PURPOSE, NON-INFRINGEMENT OF THIRD PARTY RIGHTS OR CAPABILITY OF CORRECTLY PROCESSING PROVIDING AND/OR RECEIVING

DATE INFORMATION. You understand that the Company may update or revise the Software but in so doing incurs no obligation to furnish such updates to you. However, the Company may in its discretion make updates available from time to time upon such terms and conditions as it shall determine. It is a condition of the above warranty that you install any such Software updates, as may be issued from time to time by the Company for the Software, in accordance with the Company's instructions, and if you do not do so such warranty will cease to apply. You may view current Software updates at <http://www.klarktechnik.com> and <http://www.midasconsoles.com>.

4. **Limited Liability:** THE ENTIRE RISK ARISING OUT OF YOUR USE OR PERFORMANCE OF THE SOFTWARE REMAINS WITH YOU. THE LIABILITY OF THE COMPANY FOR ANY CLAIMS ARISING OUT OF THIS LICENCE AND/OR BASED UPON THE SOFTWARE, REGARDLESS OF THE FORM OF ACTION, AND INCLUDING WORK STOPPAGE, PRODUCT FAILURE OF MALFUNCTION OR ANY OTHER COMMERCIAL LOSS OR DAMAGE, SHALL NOT EXCEED THE COST OF THE LICENCE FEE FOR THE SOFTWARE OR THE COST OF THIS PRODUCT. SUBJECT TO THE PROVISIONS OF APPLICABLE LAW, IN NO EVENT SHALL THE COMPANY BE LIABLE FOR ANY LOSS OF DATA, LOST OPPORTUNITY OR PROFITS, COST OF COVER OR SPECIAL, INCIDENTAL, CONSEQUENTIAL, OR INDIRECT DAMAGES, EVEN IF YOU ADVISE THE COMPANY OF THE POSSIBILITY OF SUCH DAMAGES. THIS IS A FUNDAMENTAL TERM OF THIS AGREEMENT AND YOU ACKNOWLEDGE THAT THE AMOUNT YOU PAID FOR THE SOFTWARE AND/OR THE PRODUCT REFLECTS THIS ALLOCATION OF RISK. NOTHING IN THIS PARAGRAPH PURPORTS TO EXCLUDE OR LIMIT THE COMPANY'S LIABILITY FOR DEATH OR PERSONAL INJURY CAUSED BY NEGLIGENCE OR ANY OTHER LIABILITY WHICH CANNOT BE EXCLUDED OR LIMITED BY LAW.
5. **Other Third-Party Computer Programs:** As referred to herein, the term "Software" refers only to proprietary Midas™ or Klark Teknik™ software, owned by the Company, that has been provided to you for installation on, or already installed in, a Product. In addition to the Software, you may have also been provided, at no additional charge, with a version of the widely-available GNU Linux Operating System, which is a modular operating system made up of hundreds of individual software components, each of which was written, and the copyright and other rights in which are owned individually, by various parties (collectively, "the GNU Linux Programs"). Each component has its own applicable end user licence agreement, and many of these agreements permit you to copy, modify, and redistribute the applicable software, but you must review the on-line documentation that shares a directory or otherwise accompanies each of the GNU Linux Programs provided to you for the specific terms and conditions. Nothing in this Licence limits your rights under, or grants you rights that supersede, the terms of any other applicable end user licence agreement. If you wish to receive a computer-readable copy of the source code for any of the GNU Linux Programs that have been provided with your Midas™ or Klark Teknik™ Product, send a cheque or money order (no cash accepted), your address and [£10.00] to cover the cost of optical media, postage and handling, to:

Midas Klark Teknik Limited
ATTN: Linux Programs CD for Midas™/Klark Teknik™
Walter Nash Road,
Kidderminster.
Worcestershire.
DY11 7HJ.
England.

In your request, indicate your Product's name and model number, serial number and version/release information. In your request, also indicate the relevant Software version/release information. This offer, made pursuant to the GNU Linux Programs' end user licence agreements, may expire according to the terms of those agreements, in which case your cheque will be returned to you or destroyed at our option. *Please note that the GNU Linux Programs that may be available to you under this offer consists of the GNU Linux Operating System components only and none of the proprietary application software developed by Midas or Klark Teknik is included.* Other updated Linux distributions containing application software are widely available from a variety of Internet sources, and are often available at minimal or no cost.

6. **Termination:** This Licence will terminate immediately if you violate any of the Licence terms. Upon termination you must discontinue use of the Software, and either destroy, erase or return to Company all copies of the Software in your possession, custody or control, including those in or on the Product.
7. **General:** This Licence constitutes the entire agreement between you and the Company with respect to this Software and, save in the case of fraud, supersedes any other communication (including advertising). Company reserves all rights not expressly granted to you in this licence. If any provision of this Licence is held unenforceable, that provision shall be enforced to the maximum extent permissible so as to give effect the intent of this Licence, and the remainder of this Licence shall continue in full force and effect. This Licence shall be governed by English law

and the Courts of England and Wales will have exclusive jurisdiction to hear and decide any dispute concerning it or its formation. No breach by you of any provision of this Licence shall be waived or discharged except with the express written consent of the Company and no failure or delay by the Company to exercise any of its rights under this Licence shall operate as a waiver thereof and no single or partial exercise of any such right shall prevent any other or further exercise of that or any other right. You acknowledge that the Company could be irreparably damaged if the terms of this Licence were not specifically enforced, and agree that the Company may seek appropriate equitable remedies with respect to breaches of this Licence, including injunctive relief, in addition to such other remedies as the Company may otherwise have available to it under applicable laws.

GNU General Public License (GPL)

For details of the Third Party Software License Attribution, Copyright and Terms and Conditions and Notices, and the GNU LESSER GENERAL PUBLIC LICENSE, see the Midas Digital Equipment GNU General Public License (GPL) Booklet part number DOC04-GPL issue A.

Precautions

Before installing, setting up or operating this equipment make sure you have read and fully understand all of this section and the “IMPORTANT SAFETY INSTRUCTIONS” at the front of this document.

This equipment is supplied by a mains voltage that can cause electric shock injury!

The following must be observed in order to maintain safety and electromagnetic compatibility (EMC) performance.

Safety warnings

Signal 0V is connected internally to the chassis.

To completely isolate this equipment from the AC mains, while observing full safety precautions (see “Power”), switch off the isolator switch (above the mains power sockets on rear of control centre) and then switch off the mains at the three mains outlets. Unplug the three mains leads from the rear of the control centre.

To avoid electrical shock do not remove covers.

General precautions

In the event of ground loop problems, disconnect the signal screen at one end of the connecting cables. Note that this can only be done when the equipment is used within a balanced system.

Do not remove, hide or deface any warnings or cautions.

Power

The power supplies contain LETHAL VOLTAGES greatly in excess of the mains voltage and its rails can produce extremely large currents that could burn out equipment and wiring if shorted.

The internal power supplies are of the switch mode type that automatically sense the incoming mains voltage and will work where the nominal voltage is in the range 100VAC to 240VAC.

Each mains inlet is to be sourced from its own separate wall-mounted mains outlet socket. Otherwise, their mains sources must be suitably

distributed so as to meet local safety regulations.

A Volex locking type plug is fitted on each supplied mains cable, which plugs into a mains IEC connector on the equipment. When fitted properly the Volex plug locks into place, preventing it from working loose, or being inadvertently knocked loose or pulled out. To fit a Volex plug, insert it into the mains IEC connector and push it in until it locks in place. Then, check to make sure it is locked in place. To remove it, release its locking device and then pull it out. When fitting or removing a Volex plug, always hold the plug itself and never use the cable, as this may damage it.

During operation of the control centre, a minimum of two of its three mains inlets must be connected and supplying power.

When removing the equipment’s electric plugs from the outlets, always hold the plug itself and not the cable. Pulling out the plug by the cable can damage it.

Never insert or remove an electric plug with wet hands.

Do not connect/disconnect a mains power connector to/from the control centre while power is being applied to it. Switch the power off first.

Before switching the control centre on or off, make sure that all monitor loudspeaker power amplifiers are turned off or muted.

Handling the equipment

Completely isolate the equipment electrically and disconnect all cables from the equipment before moving it.

When lifting or moving the equipment, always take its size and weight into consideration. Use suitable lifting equipment or transporting gear, or sufficient additional personnel.

Do not insert your fingers or hands in any gaps or openings on the equipment, for example, vents.

Do not press or rub on the sensitive surface of the GUI screens.

If the glass of the GUI screen is broken, liquid crystals shouldn't leak through the break due to the surface tension of the thin layer and the type of construction of the LCD panel. However, in the unlikely event that you do make contact with this substance, wash it out with soap.

Installation

Before installing the equipment:

- Make sure the equipment is correctly connected to the protective earth conductor of the mains voltage supply of the system installation through the mains leads.
- Power to the equipment must be via a fused spur(s).
- Power plugs must be inserted in socket outlets provided with protective earth contacts. The electrical supply at the socket outlets must provide appropriate over-current protection.
- Both the mains supply and the quality of earthing must be adequate for the equipment.
- Before connecting up the equipment, check that the mains power supply voltage rating corresponds with the local mains power supply. The rating of the mains power supply voltage is printed on the equipment.

Location

Ideally a cool area is preferred, away from power distribution equipment or other potential sources of interference.

Do not install the equipment in places of poor ventilation.

Do not install this equipment in a location subjected to excessive heat, dust or mechanical vibration. Allow for adequate ventilation around

the equipment, making sure that its fans and vents are not obstructed. Whenever possible, keep the equipment out of direct sunlight.

Do not place the equipment in an unstable condition where it might accidentally fall over.

Make sure that the mains voltage and fuse rating information of the equipment will be visible after installation.

Audio connections

To ensure the correct and reliable operation of your equipment, only high quality, balanced, screened, twisted pair audio cable should be used.

XLR connector shells should be of metal construction so that they provide a screen when connected to the control centre and, where appropriate, they should have Pin 1 connected to the cable screen.

Electrostatic discharge (ESD) precautions



Observe full electrostatic discharge (ESD) — also known as “anti-static” — precautions when carrying out procedures in this manual that are accompanied by the ESD Susceptibility Symbol (shown above). This caution symbol shows you that ESD damage may be caused to items unless proper ESD precautions are taken, which include the following practices:

- Keep the work area free from plastic, vinyl or styrofoam.
- Wear an anti-static wrist strap.
- Discharge personal static before handling devices.
- Ground the work surface.
- Avoid touching ESD-sensitive devices.

Radio frequency interference—Class A device

This equipment has been tested and found to comply with the limits for a Class A digital device, pursuant to Part 15 of the FCC Rules. These limits are designed to provide reasonable protection against harmful interference when the equipment is operated in a commercial environment. This equipment generates, uses, and can radiate radio frequency energy and, if

not installed and used in accordance with the instruction manual, may cause harmful interference to radio communications. Operation of this equipment in a residential area is likely to cause harmful interference in which case the user will be required to correct the interference at his own expense.

Electric fields

Caution:

In accordance with Part 15 of the FCC Rules & Regulations, "... changes or modifications not expressly approved by the party responsible for compliance could void the user's authority to operate the equipment."

Should this product be used in an electromagnetic field that is amplitude modulated by an audio frequency signal (20Hz to 20kHz), the signal to noise ratio may be degraded. Degradation of up to 60dB at a frequency corresponding to the modulation signal may be experienced under extreme conditions (3V/m, 90% modulation).

Safety equipment

Never remove, for example, covers, housings or any other safety guards. Do not operate the equipment or any of its parts if safety guards are ineffective or their effectiveness has been reduced.

Optional equipment

Unless advised otherwise, optional equipment must only be installed by service personnel and in accordance with the appropriate assembly and usage regulations.

Special accessories

To comply with part 15 of the FCC Rules, any special accessories (that is, items that cannot be readily obtained from multiple retail outlets) supplied with this equipment must be used with this equipment; do not use any alternatives as they may not fulfil the RF requirement.

Recommandations

Avant l'installation, la mise au point ou l'exploitation de cet équipement, veiller à lire attentivement et à comprendre l'intégralité de ce chapitre et la partie "CONSIGNES DE SÉCURITÉ IMPORTANTES" au début de ce manuel.

Cet équipement est alimenté par une tension de secteur pouvant provoquer des blessures par choc électrique !

Les points suivants doivent être observés afin de maintenir la sécurité et une compatibilité électromagnétique (CEM) correcte.

Avertissements de sécurité

Une tension 0V de signal est raccordée en interne au châssis.

Afin de déconnecter complètement cet appareil du secteur CA, tout en observant les précautions de sécurité (voir "Puissance"), couper le sectionneur (au-dessus des prises secteur sur le panneau arrière du centre de contrôle), puis couper le secteur aux trois socles de secteur. Isoler l'appareil en débranchant les trois câbles de secteur du panneau arrière du centre de contrôle.

Afin d'éviter un choc électrique, ne pas retirer les couvercles.

Recommandations générales

En cas de problème de boucle de terre, débrancher le blindage de signal à une extrémité des câbles de raccordement. Il convient de noter que cela n'est faisable que si l'équipement est utilisé dans un système équilibré.

Ne pas retirer, cacher ni dégrader les avertissements ou les mises en garde.

Puissance

Les alimentations électriques contiennent des TENSIONS LÉTALES largement supérieures à la tension de secteur et les barres peuvent produire des courants extrêmement élevés capables de griller l'équipement et le câblage en cas de court-circuit.

Les alimentations électriques internes sont des alimentations à découpage détectant

automatiquement la tension de secteur d'entrée et fonctionnant lorsque la tension nominale se trouve dans la plage de 100 VCA à 240 VCA.

Chaque prise de secteur doit être raccordée à son propre socle mural séparé. Sans quoi, les alimentations de secteur doivent être correctement distribuées conformément aux réglementations locales de sécurité.

Chaque câble d'alimentation fourni est équipé d'une fiche Volex verrouillable qui se branche dans une prise connecteur CEI sur l'appareil. Lorsqu'elle est montée correctement la fiche Volex se verrouille dans son logement, l'empêchant de se desserrer ou d'être déconnectée par inadvertance. Pour brancher une fiche Volex, l'insérer dans la prise connecteur secteur CEI et la pousser jusqu'à ce qu'elle se verrouille dans son logement. Penser ensuite à vérifier qu'elle soit correctement verrouillée. Pour l'enlever, libérer son dispositif de verrouillage pour ensuite la tirer. Lors de la connection ou déconnection d'une fiche Volex, toujours saisir la fiche elle-même et ne jamais utiliser le câble, car cela pourrait l'endommager.

Pendant le fonctionnement du centre du contrôle un minimum de deux de ses trois entrées secteur doivent être connectés et alimentation.

Pour débrancher les cordons d'alimentation de l'équipement des prises murales, tenir toujours la prise et non le câble. Tirer la prise par le câble peut l'endommager.

Ne jamais brancher ni débrancher une prise électrique avec des mains humides.

Ne jamais brancher/débrancher un connecteur de secteur au/du centre de contrôle s'il est sous tension. Mettre d'abord hors tension.

Avant de mettre le centre de contrôle ou se désactiver, assurez-vous que tous les amplificateurs de haut-parleur de surveiller l'alimentation sont désactivées ou coupé.

Manipulation de l'équipement

Isoler électriquement et totalement l'appareil et débrancher tous ses câbles avant de le déplacer.

En soulevant ou en déplaçant l'appareil, tenir toujours compte de sa taille et de son poids. Utiliser un dispositif de levage adapté ou un matériel de transport, ou encore suffisamment de personnel supplémentaire.

Ne pas introduire les doigts ni les mains dans les fentes ni les ouvertures de l'appareil, telles que les ouïes de ventilation.

Ne pas appuyer ou de frotter sur la surface sensible des écrans GUI.

Si le verre de l'écran GUI est cassé, les cristaux liquides ne doit pas s'infiltrer dans la rupture en raison de la tension superficielle de la couche mince et le type de construction de l'écran LCD. Toutefois, dans le cas improbable où vous ne prenez contact avec cette substance, le laver avec du savon.

Installation

Avant d'installer l'équipement :

- Vérifier qu'il est correctement raccordé au conducteur de terre de protection de l'alimentation de tension de secteur du système par les câbles de secteur.
- L'équipement doit être alimenté par l'intermédiaire de(s) dérivation(s) avec fusible.
- Les prises doivent être branchées sur des prises femelles dotées de contacts de terre de protection. L'alimentation électrique aux prises femelles doit assurer une protection adéquate contre la surintensité.
- L'alimentation de secteur et la qualité de la mise à la terre doivent être d'un niveau convenant à l'appareil.
- Avant de brancher l'équipement, vérifier que la tension nominale de l'alimentation de secteur correspond à l'alimentation de secteur locale. La valeur nominale de la tension d'alimentation de secteur est imprimée sur l'équipement.

Lieu d'installation

L'idéal est de disposer d'une zone fraîche, à l'écart de tout équipement de distribution électrique ou d'autres sources potentielles d'interférences.

Ne pas installer l'équipement dans des endroits mal aérés.

Ne pas installer cet équipement dans un local exposé à la chaleur, à la poussière ou à des vibrations mécaniques excessives. Prévoir une ventilation adéquate autour de l'appareil, en s'assurant que les ventilateurs et les ouïes ne sont pas obstrués. Dans la mesure du possible, le garder à l'écart de la lumière directe du soleil.

Ne pas placer l'appareil sur un support instable d'où il pourrait tomber par accident.

S'assurer que les informations relatives à la tension de secteur et au calibre des fusibles de l'équipement sont visibles après l'installation.

Connexions audio

Afin d'assurer le fonctionnement correct et fiable de l'équipement, utiliser uniquement un câble audio à paire torsadée, blindé, équilibré, de première qualité.

Les boîtiers de connecteurs XLR doivent être en métal de façon à former un blindage lors du raccordement au centre de commande et, le cas échéant, la Fiche 1 devrait être raccordée au blindage du câble.

Electrostatic discharge (ESD) precautions



Observe full electrostatic discharge (ESD) — also known as “anti-static” — precautions when carrying out procedures in this manual that are accompanied by the ESD Susceptibility Symbol (shown above). This caution symbol shows you that ESD damage may be caused to items unless proper ESD precautions are taken, which include the following practices:

- Keep the work area free from plastic, vinyl or styrofoam.
- Wear an anti-static wrist strap.
- Discharge personal static before handling devices.
- Ground the work surface.
- Avoid touching ESD-sensitive devices.

Interférences radioélectriques - Dispositif de Classe A

Cet équipement a été testé et est conforme aux limites d'un produit numérique de Classe A, en application de la Partie 15 des Règles de la FCC. Ces limites sont destinées à assurer une protection raisonnable contre les interférences néfastes lorsque l'équipement fonctionne dans un environnement commercial. Cet équipement génère, utilise et peut rayonner de l'énergie de fréquence radio et, s'il n'est pas installé et utilisé conformément au manuel d'exploitation, il peut causer des interférences dommageables aux communications radio. L'utilisation de cet équipement dans une zone résidentielle est susceptible de provoquer des interférences néfastes, dans quel cas l'utilisateur se devra de corriger les interférences à ses propres frais.

Champs électriques

Attention :

Conformément à la Partie 15 des Règles et Réglementations de la FCC, "... tout changement ou toute modification non expressément approuvé(e) par la partie responsable de la conformité pourrait annuler l'autorisation accordée à l'utilisateur d'utiliser cet appareil. "

Dans le cas où ce produit est utilisé dans un champ électromagnétique dont l'amplitude est modulée par un signal audiofréquence (20 Hz à 20 kHz), le rapport signal-bruit peut être

détérioré. Une détérioration atteignant 60 dB à une fréquence correspondant au signal de modulation peut se produire dans des conditions extrêmes (modulation 90%, 3 V/m).

Équipement de sécurité

Ne jamais retirer les couvercles, les boîtiers ni autres caches de sécurité. Ne pas faire fonctionner l'appareil ni aucun de ses composants si les protecteurs de sécurité ne sont pas en mesure de remplir leur fonction ou si leur efficacité a été réduite.

Équipement en option

Sauf indication contraire, tout équipement en option doit être installé uniquement par le personnel d'entretien et conformément aux réglementations appropriées de montage et d'usage.

Accessoires spéciaux

Aux fins de la conformité à la Partie 15 des Règles de la FCC, tous les accessoires spéciaux fournis avec cet équipement (à savoir les articles que l'on ne peut se procurer facilement auprès des chaînes de détaillants), doivent être utilisés avec cet équipement ; ne pas utiliser de composants de remplacement car ils pourraient ne pas respecter l'exigence de RF.

Contents

Cover page	i
Information page	iii
IMPORTANT SAFETY INSTRUCTIONS	v
INSTRUCTIONS DE SÉCURITÉ IMPORTANTES	vi
PRO6 EC-Declaration of Conformity	vii
PRO6 EC-Declaration of Conformity	ix
PRO9 EC-Declaration of Conformity	xi
Licences	xiii
Precautions	xvii
Recommandations	xxi
Contents	xxv

Overview

Chapter 1	Introduction	3
	About this manual	3
	Structure	3
	Conventions	4
	Terminology	4
	GUI diagrams	5
	Training	5
	PRO Series user documentation	5
	PRO Series host software version	5
	Warranty and registration	5
	Service and support	5
Chapter 2	PRO Series Live Audio Systems	7
	Introducing the PRO3	7
	Introducing the PRO6	7
	Introducing the PRO9	7
	Overview	8
	Key features	9
	Applications	13

System components	.14
FOH and MON	.17
System buses	.17
Mix matrix	.18
Processing	.20
Processing components	.20
Input channel processing	.20
Mix channel processing	.21
Output channel processing	.21
Effects processing and GEQs	.22
Audio physical connections	.22
Surround capabilities	.22
Network	.23
Reliability (redundancy)	.23
Control software	.23
GUI	.24
System card expansion	.24
Console linking	.24
Integration of third party hardware/software	.24

Chapter 3	About The Control Centre	.27
	Overview of the control centre	.27
	Bay and GUI layout	.28
	Control surface	.29
	GUI	.30
	Front and rear panel connections	.31
	External interfaces and peripheral devices	.32
	Mix buses	.32
	Automation	.33
	Processing elements	.33

Getting Started

Chapter 4	Setting Up The System	.37
	Initial set-up procedure	.37
	Unpacking the equipment	.37
	Making up a rack	.37
	Outboard equipment rack requirements	.37
	Wiring instructions	.38
	Powering the system	.42
	Switching the control centre on/off	.43
	Setting up the ID of the unit(s)	.44

Basic Operation Of The PRO Series

Chapter 5	Before You Start	.47
	Principles of operation	.47
	Operating modes	.47
	Normal mode	.47
	Using the 4-channel input bay as area B	.47

	Operating the top output fast strips from the master bay	48
	Controlling the mix buses in flip mode	48
	Hints and tips	48
	Saving your work	49
	Saving a show versus storing a scene	49
	Shutting down the control centre properly	49
Chapter 6	Working With The Control Centre	51
	About the PRO Series controls	51
	About channel operation	52
	About GUI operation	52
	Click	53
	Drag	53
	Common GUI screen elements	53
	Parameter values displayed on touch	54
	Operating the GUI screen controls	54
	Using drop-down lists	54
	Spin buttons	55
	About windows	55
	Using the GUI menu	56
	Text editing	57
Chapter 7	Navigation	59
	An introduction to navigation	59
	Navigating the input channels	59
	Navigating the mix buses	64
	Navigating the output channels	66
	Navigation via the GUI	68
	Fault finding a problem channel	69
Chapter 8	Patching	71
	Introduction	71
	Terms used in PRO Series patching	71
	About the Patching screen	71
	What the Patching screen symbols mean	74
	About the tabs in the From and To sections	75
	Navigating to the Patching screen	85
	About the devices on the stage and FOH I/O tabs	85
	Patching tooltips	88
	Standard tooltip	88
	List tooltip	88
	About the patching procedure	89
	Configuring the devices	89
	About the configuration window	90
	Device configuration procedure	90
	Configuring the snake type	92
	Setting up the I/O rack devices	92
	Device set-up procedure	93
	How to patch	94
	Working with patch connectors	94
	Single patching (SINGLE)	96
	Sequence patching (SEQ.)	97

	Automatic patching (AUTO)	97
	Clearing all current patching	98
Chapter 9	Basic Operation	99
	Setting a mic amplifier's input gain	99
	Setting the high and low pass filters	100
	Input equalisation (E zone)	101
	Input dynamics processing (D zone)	102
	Output processing	103
	Using VCA/POP groups	104
	Configuring VCA/POP groups	105
	Setting up a mix	106
	Mix bus routing	108
	Linking	108
	Using fader flip	108
	Setting up the effects rack	109
	Simple routing to master stereo outputs	111
	Scene and show management (automation)	112
	Managing the shows	112
	Managing the scenes	114
	Additional control — managing events	116
	Show editor	117
	Configuring the inputs and outputs	118
	Using copy and paste	118
	Copy and paste rules and restrictions	119
	User library (presets)	119
	Surround panning	120
	Two-man operation	122
	Saving your show files to a USB memory stick	123
	External AES50 synchronisation	124
	Security (locking mode)	124

Advanced Operation And Features

Chapter 10	Stereo Linking	127
	Changing the linking options	128
	Linking the master channels	129
Chapter 11	Panning	131
	Stereo panning	131
	SIS™ (LCR) mode	131
	SIS image control knob fully clockwise (LCR)	132
	SIS image control knob fully anti-clockwise (stereo)	132
	SIS image control knob centred (equal power)	132
	Surround panning	133
	About the controls in surround mode	134
	Speaker placement	136

Chapter 12	Soloing	137
	Using solo A/B	137
	Solo hierarchy	139
	Solo in place (SIP)	139
Chapter 13	Muting	141
Chapter 14	Monitors And Communications	143
	Monitors (A and B)	143
	Delay (GUI only)	145
	Solo system	145
	solo in place switch	146
	C/O switch	147
	Monitor output (a and b) sections	147
	source (a and b) sections	148
	solo (a and b) sections	148
	solo mode section (GUI only)	149
	solo system section	149
	Signal generator	150
	Talk osc/routing	152
	Internal talk groups	153
	Talk mic	154
	Internal talk mic	154
	External talkback	155
Chapter 15	Graphic Equaliser (GEQ)	157
	Overview of the GEQs	157
	About the Graphic EQs screen	158
	About the GEQ window	159
	GEQ front panel features	160
	Configuring the number of GEQs (and effects)	161
	Copying settings between GEQs	162
Chapter 16	Internal Effects	163
	Overview of the internal effects	163
	Rack unit number allocation	164
	About the effect window	164
	Working with the effects	165
	Effect configuration	165
	Effect programs	166
	Delay effect	166
	Virtual DN780 Reverb effect	168
	Flanger effect	170
	Phaser effect	171
	Pitch Shifter effect	173
	Feedback	174
	SQ1 Dynamics effect	174
	3-Band Compressor effect	175

Chapter 17	Control Groups	177
	VCA and POP groups	177
	VCA fast strips	178
	POP groups	179
	Working with VCA/POP groups	179
	Auto-mute (mute) groups	180
	Talk groups	181
	About the control group screens	182
	Management section	182
	Programming the groups	183
	Configuring the groups	184
Chapter 18	Copy And Paste	185
	Channels versus scenes	185
Chapter 19	Assignable Controls (I Zone)	187
	About the I zone	187
	Controlling a rotary control	187
	About the Assignable Controls window	188
	Using the I zone to control an internal effect/GEO	190
	About the assignable controls panel on the GUI	190
	Rack and unit control navigation	191
	Controlling an internal effect via the I zone	193
	Controlling a GEO via the I zone	194
Chapter 20	Scenes And Shows (Automation)	197
	About automation	197
	Automation controls	198
	next LCD button	199
	Automation screen	199
	Using the right-click menu	200
	Scenes	201
	Scene contents	202
	Point scenes	202
	Numbering and navigation	202
	Global scene	202
	Initial snapshot scene (scene 0)	202
	Date and time	203
	Scene cue list	203
	Configuring the scene cue list view	205
	Editing scene properties	205
	Adding a new scene	206
	Copying and deleting scenes	206
	Changing the order of the scenes	207
	Overriding store scope	207
	Using patching in automation	208
	Using zoom	208
	Show files	209
	Managing show files	209
	Managing show files on the Files screen	210
	Rehearsals	210
	Safes	211

Chapter 21	Scope (Automation)	213
	About scope	213
	About the Recall Scope screen	213
	Selecting scope parameter sections	215
	Selecting bus parameters	218
	Saving scope parameters in a scene	219
	Using store scope	219
Chapter 22	Events (Automation)	221
	About events	221
	MIDI	221
	GPIO	221
	Internal	221
	Crossfades	221
	Global scene	221
	Connecting up the MIDI/GPIO equipment	222
	About the Edit Event window	222
	Programming events	223
Chapter 23	Crossfades (Automation)	227
	About the crossfade Edit Event window	227
	About the crossfade parameters	228
	Crossfade set up section in the Edit Event window	229
	How a crossfade operates	230
	Crossfade groups	231
	Global events	233
	Manually controlling a crossfade	234
Chapter 24	User Libraries (Presets)	235
	About the Preset Manager screen	235
	Managing user libraries	236
	Deleting presets from a user library	237
Chapter 25	File Management	239
	About the Files screen	239
	About the Master Controller File Synchronisation window	241
Chapter 26	Using Other Devices With The PRO Series	243
	Using multiple digital consoles	243
	Synchronising the consoles	243
	Sharing DL431 Mic Splitter A and B inputs	244
	Using an external USB mouse	244
	Using an external USB keyboard	244
	Using an external monitor	245
Chapter 27	Changing The User Settings	247
	Setting the meter preferences	247
	Configuring a virtual soundcheck	248
	Restoring the PRO Series defaults	248
	Checking the PRO Series build information	248
	Setting the configuration preferences	249
	Changing the user interface preferences	250

Changing the signal processing preferences	250
Configuring the channels, groups and internal units	251
Changing the default input/output names	251
Adjusting PRO Series illumination	251
Setting the time and date	252

Chapter 28	Delay Compensation (Latency)	253
	Insert compensation	253
	GEQ compensation	254
	GUI Delay Compensation options	254
	Monitor Mode (Align with Masters)	256
	Zones	257
	Master to matrix post-processing option	257
	Solo bus delay compensation	258
	Typical configurations	259
	FOH mix setup	259
	FOH mix low latency	260
	Monitor mix	261
	Monitor mix (low latency)	262

Description

Chapter 29	Panel Connections	265
	Front panel connections	265
	Rear panel connections	266
	Mains power and ventilation section	266
	External connections and communications (centre left) section	267
	Audio, networking and synchronisation section	273
	I/O section (far right)	276

Chapter 30	Inputs	277
	Input channel routing	277
	Input channel areas of the control surface	278
	Input fast strips, channel strips and mix buses	279
	Inputs on the GUI	280
	GUI input fast strips	280
	GUI channel strips (inputs)	280
	Input metering	282
	Channel configuration controls	283
	Input channel ID (GUI only)	284
	Input channel source select (GUI only)	284
	Input channel delay (GUI only)	284
	Stereo linking (GUI only)	284
	Safes	285
	Mic amp input gain (preliminary input processing)	286
	Using gain swap	288
	Processing order	288
	Direct output	288
	Dynamics (D zone)	290
	Compressor	290
	Compressor graph	292

	Gate	294
	Side chain	296
	Insert	298
	EQ (E zone)	299
	EQ graph	301
	Mixes	303
	Master controls, solo/mute and fader	306
	Masters sections and pan control	306
	LCD select button	308
	Mute, solo and safes	308
	Fader	309
Chapter 31	Outputs	311
	Output channel routing	311
	Output channel areas on the control surface	312
	Output fast strips, channel strips and mix buses	313
	Outputs on the GUI	314
	Output fast zone (Overview screen)	314
	GUI channel strips	314
	Output metering	318
	Talk	319
	Dynamics and EQ	319
	Compressor (D zone)	320
	EQ (E zone)	321
	EQ graph	325
	Mute, safes, level and solo	325
	Output channel configuration controls	327
	Output channel ID (GUI only)	327
	Output channel source/destination (GUI only)	327
	Stereo linking (GUI only)	328
	Gain swap (GUI only)	328
	Mix mode (GUI only)	328
	Input mode (GUI only)	328
	Fader linking (GUI only)	328
	Bus trim (GUI only)	328
	Direct input (GUI only)	328
	Safes	329
	Insert (GUI only)	329
	Output channel delay (GUI only)	329
	Processing order	329
	Mixes	329
	Masters	330
Chapter 32	GUI Menu	331
	Elements of the GUI menu	332
	GUI menu flowchart	333
	GUI menu options	336

Appendices

Appendix A	Application Notes	341
	Spatial imaging system (SIS™)	341
	PRO Series compressor modes (dynamic)	341
	Description	341
	Compressor envelope modes	343
	PRO Series input channel EQ modes	345
	Basic specification	345
	Description of the input channel EQ modes	345
	PRO Series output channel EQ modes	347
	Basic specification	347
	Description of the output channel EQ modes	347
Appendix B	Technical Specification	349
	PRO Series general statistics	349
	PRO Series general specifications	351
	PRO Series audio performance specifications	352
	Frequency response	352
	Gain error at 1kHz	352
	Input CMRR	353
	Distortion at 0dBu	353
	Distortion at +20dBu	354
	Signal path noise 22Hz to 22kHz unweighted	355
	Dynamic range 22Hz to 22kHz unweighted	355
	PRO Series system inputs and outputs	356
	DL251 I/O Box	356
	DL351 I/O Box	356
	DL451 I/O Box	357
	DL431 Splitter (option)	358
	DL371 DSP/Router	359
	PRO Series Control Surface	360
	PRO Series input and output characteristics	362
	Analogue input characteristics	362
	Analogue output characteristics	362
	Digital I/O characteristics	363
	Miscellaneous digital characteristics	363
	PRO Series main processing functions	364
	Main input channel functions	364
	Auxiliary input channel functions	365
	Output channel functions	366
	Effects channel functions	367
	PRO Series status functions	368
	Meters	368
	Screens	368
	Screen functions	368
	LCD switches	368

Appendix C	Klark Teknik DN370 GEQ	369
	Notes	369
	Using the GEQ	369
	Studio and creative use	369
	Live use (MON)	369
	Bypassing the EQ	370
	Audio signal path	371
Appendix D	Klark Teknik DN780 Reverb	373
	Parameter application notes	373
	Pre-delay	373
	Pattern	373
	Level	373
	Decay	373
	LF key	373
	HF key	374
	Room size	374
	About the special effects programs	374
	Direct signal	374
	“Delay” effect	374
	“ADT” effect	374
	“Multi-Tap Echo” effect	375
	“Sound-On-Sound” effect	375
	“Infinite Room” effect	376
	“Alive”, “Non-Linear” and “Reverse” effects	376
	Technical specifications	377
	Audio	377
	Digital	377
	Parameters	377
	Controls	377
Appendix E	I/O Modules	379
	DL441 analogue input module	380
	DL442 analogue output module	381
	DL443 analogue Jack I/O module	382
	DL444 analogue D-type I/O module	384
	Connecting to eight XLRs	387
	Pinouts for the remote status connector	388
	DL452 digital I/O module	389
Appendix F	Replacing A Module	391
	Replacing a module	391
Appendix G	Troubleshooting	393
	No audio	393
	Diagnostics	393
	About the Diagnostics Inspector window	395
	Swapping the active network	396
	Swapping the active master controller	396
	Synchronising the files	397
	Mapping a GUI screen to another bay	398
	Reset switches	398

	Troubleshooting automation	399
	Error messages	399
	Error condition messages	400
	Error description messages	401
Appendix H	Updating PRO Series Host Software	407
	About the PRO Series updater	407
	About the updater screen	408
	Using the PRO Series updater	410
	What you will need	410
	Preparation	410
	Updating your system	410
Appendix I	Documentation	415
	System user documentation	415
	Supplementary documentation	416
Appendix J	Reference Tables	417
	Definition of the primary buses	417
	Navigating to the Patching screen	418
Appendix K	Parameters Affected By Scope	421
	Introduction	421
	Overview	422
	Inputs	423
	Patching	423
	Configuration	424
	Dynamics	426
	Insert	427
	EQ	428
	Aux send	429
	Matrix send	430
	Fader	431
	Returns (Aux Returns)	433
	Patching	433
	Configuration	434
	Dynamics	435
	Insert	435
	EQ	435
	Aux send	435
	Matrix send	436
	Fader	437
	Auxes (Aux Sends)	439
	Patching	439
	Configuration	440
	Dynamics	441
	Insert	442
	EQ	443
	Aux send	443
	Aux preset	443
	Matrix send	444
	Fader	445

Matrices	447
Patching	447
Configuration	448
Dynamics	449
Insert	450
EQ	451
Aux send	451
Aux preset	451
Matrix send	451
Fader	452
Masters	453
Patching	453
Configuration	454
Dynamics	455
Insert	456
EQ	457
Aux send	457
Aux preset	457
Matrix send	458
Fader	459
GEQ rack	460
Patching	460
GEQ	461
Effects rack	462
Patching	462
Effects	463
Groups	464

Appendix L Parameters Affected By Automate Patching 465

Inputs	465
Auxes	466
Matrices	466
Masters	467
Effects	467
System devices	468
Monitors	468

Appendix M Parameters Protected By Safes 469

Overview	469
Inputs	470
Input parameters not affected by the safes	471
EQ safe	472
DYN (dynamic) safe	473
MIC safe	475
AUTO (automation) safe	476
MUTE safe	476
FADER safe	477
Auxes (Aux Sends)	478
Aux parameters not affected by the safes	479
EQ safe	480
DYN (dynamic) safe	482
MIC safe	483

AUTO (automation) safe	483
MUTE safe	484
FADER safe	485
Returns (Aux Returns)	486
Return parameters not affected by the safes	487
EQ safe	487
DYN (dynamic) safe	487
MIC safe	488
AUTO (automation) safe	489
MUTE safe	489
FADER safe	490
Matrices	491
Matrix parameters not affected by the safes	492
EQ safe	493
DYN (dynamic) safe	495
MIC safe	496
AUTO (automation) safe	496
MUTE safe	497
FADER safe	498
Masters	499
Master parameters not affected by the safes	500
EQ safe	501
DYN (dynamic) safe	503
MIC safe	504
AUTO (automation) safe	504
MUTE safe	505
FADER safe	506
Groups	507
EQ safe	507
Dynamic safe	507
Mic safe	507
Automation safe	508
Mute (MTE) safe	509
Fader (FDR) safe	510

Appendix N

Parameters Affected By Copy And Paste	511
Overview	511
Inputs	512
Configuration	512
Compressor	514
Gate	516
EQ	517
Bus sends	518
Master routing	519
Aux	520
Configuration	520
Compressor	521
Gate	522
EQ (GEO)	522
Bus sends	524
Master routing	525

- Return 526
 - Configuration 526
 - Compressor 526
 - Gate 527
 - EQ 527
 - Bus sends 527
 - Master routing 528
- Matrix 529
 - Configuration 529
 - Compressor 530
 - Gate 531
 - EQ (GEQ) 531
 - Bus sends 532
 - Fader section 533
- Master 534
 - Configuration 534
 - Compressor 535
 - Gate 536
 - EQ (GEQ) 536
 - Bus sends 537
 - Master routing 538

Appendix O Parameters Affected By Stereo Linking 539

- Overview 539
- Inputs 540
 - Input controls 540
 - Direct output 541
 - Direct input 541
 - Filters 542
 - Dynamics 543
 - Insert 545
 - EQ 546
 - Bus sends 547
 - Master routing 548
 - Fader 549
 - Delay 550
- Aux 551
 - Input controls 551
 - Direct output 552
 - Direct input 552
 - Filters 552
 - Dynamics 553
 - Insert 554
 - EQ 555
 - Bus sends 556
 - Master routing 557
 - Fader 558
 - Delay 559
- Return 560
 - Input controls 560
 - Direct output 560
 - Direct input 561

Filters	561
Dynamics	561
Insert	561
EQ	561
Bus sends	562
Master routing	563
Fader	564
Delay	564
Matrix	565
Input controls	565
Direct output	565
Direct input	566
Filters	566
Dynamics	567
Insert	568
EQ	569
Bus sends	570
Master routing	570
Fader	571
Delay	572
Master	573
Input controls	573
Direct output	574
Direct input	574
Filters	574
Dynamics	575
Insert	576
EQ	577
Bus sends	578
Master routing	578
Fader	578
Delay	579

Appendix P

Parameters Copied Through Scenes	581
Inputs (input channels)	582
Config sections	582
Comp./Output Dyn	584
Gates	585
EQs	586
Aux Sends	587
Matrix Sends	588
Fader Sections	589
Recall Scope	589
Store Scope	589
Routing	590
Aux Returns (return channels)	591
Config sections	591
Comp./Output Dyn	592
Gates	592
EQs	592
Aux Sends	592
Matrix Sends	592

Fader Sections	593
Recall Scope	594
Store Scope	594
Routing	594
Aux Sends (aux channels)	595
Config sections	595
Comp./Output Dyn	596
Gates	597
EQs	597
Aux Sends (1 to 16)	598
Matrix Sends (1 to 16)	598
Fader Sections	599
Recall Scope	600
Store Scope	600
Routing	600
Matrix (matrix channels)	601
Config sections	601
Comp./Output Dyn	602
Gates	603
EQs	603
Aux Sends	604
Matrix Sends	604
Fader Sections	605
Recall Scope	606
Store Scope	606
Routing	606
GEQs	607
Effects	607
VCA/POP (groups)	607
Masters (master channels)	608
Config sections	608
Comp./Output Dyn	609
Gates	610
EQs	610
Aux Sends	611
Matrix Sends	611
Fader Sections	612
Recall Scope	613
Store Scope	613
Routing	613
Misc (miscellaneous)	614
Appendix Q	
Service Information	615
Routine maintenance	615
Cleaning the control centre	615
Cleaning a GUI screen	615
Equipment disposal	615
Glossary	617

Overview

Chapter 1: Introduction

Welcome to the PRO Series Live Audio Systems. The PRO Series, which comprises the PRO3, PRO6 and PRO9, provide user-friendly, state-of-the-art, high performance digital systems specifically designed for live use.

The control centre, which forms an integral part of its live audio system, was conceived by Midas to offer audio professionals high-performance audio equipment, designed to provide no-compromise sonic quality with a feature set that offers all essential facilities and functions. It represents the very best of British design and engineering combined with contemporary, efficient manufacturing methods, and will give you many years of reliable service.

So, to obtain the best results with a minimum of effort, please read this Owner's Manual and, finally, enjoy your Midas PRO Series Live Audio System!

About this manual

This is the Owner's Manual for the PRO Series Live Audio Systems. Its purpose is to familiarise the user with the PRO Series Live Audio Systems and show how to operate the PRO Series Control Centres.

This document is aimed at professionals, such as front of house (FOH) and monitor (MON) engineers, who will be using this equipment in a live performance environment. It is assumed that the reader has prior experience of using professional audio equipment and has, most likely, undergone training on this system.







Note: *The content of this manual does not supersede any information supplied with any other item of this PRO Series Live Audio System.*

Structure

To help you find your way around the manual, it has been divided into the following main areas:

- **Overview:** This gives an overview of each PRO Series Live Audio System and associated PRO Series Control Centre, and contains information about this manual.
- **Getting Started:** This shows you how to set up and power up a PRO Series Live Audio System.
- **Basic Operation Of The PRO Series Control Centres:** This shows you how to use the controls of a PRO Series Control Centre, how to navigate its control surface and GUI, how to route (patch) its channels and buses, and how to carry out basic operations in order to get some audio out of it.
- **Advanced Operations And Features:** This describes the advanced features of the control centre and gives detailed operating instructions.
- **Description:** This gives a detailed description of the PRO Series Control Centre hardware, and the controls and their functions on both the control surface and GUI. It provides useful reference material.
- **Appendices:** This provides reference material and technical information on the PRO Series, such as application notes, signal path diagrams, technical specifications, service information etc.

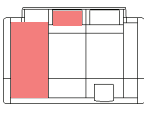
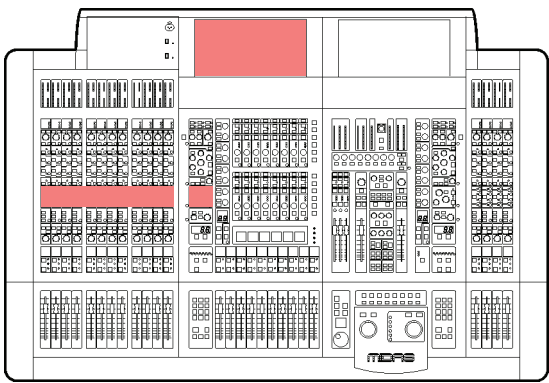
Conventions

- Hand symbols, such as,  (pushbutton, trackball etc.) and , are used to show the operation of the physical controls on the control surface. GUI operation is indicated by a pointer , which represents a 'click' operation.
- The graphics shown right are used to differentiate between diagrams of the control surface (immediate right) and GUI (far right). Placement is generally towards the upper-right corner of the diagram. 
- Outline drawings are strategically placed throughout the manual to reference information to the appropriate area(s) on the control surface/GUI of the PRO Series Control Centre. The small version (left) indicates bay and GUI location, while the larger one (right) can pinpoint control sections (for example, the EQ areas of the 12-channel input bay shown right). Target areas are shaded in red.  
- Unless otherwise stated, illumination of a control (pushbutton, switch, control knob etc.) on the control surface/GUI of a PRO Series Control Centre indicates an "on", "active" or "enabled" state. Conversely, an extinguished condition indicates the control is "off", "inactive" or "disabled".
- The following types of pushbutton are used on the control surface:
 - "switch" - a latching pushbutton, that is, one that changes its on/off status.
 - "button" - a non-latching pushbutton.
 - "key" - a keyboard-type pushbutton. Usually used for entering data, such as a number or character.
- Generally, control names are the same whether they are on the control surface or the GUI. However, in cases where they differ, both names will be given, separated by a forward slash "/". The control name shown on the GUI will always be last and enclosed in square brackets "[]".
- Hints and tips are used to convey useful information to the user. These have a drawing pin graphic (shown right) next to them. 

Terminology

To support both FOH and MON use, the terminology has been chosen very carefully to apply equally to both (see "Glossary" on page 617). For a definition of the primary buses on the PRO Series Control Centres, see "Definition of the primary buses" on page 417.

GUI diagrams

This manual contains numerous diagrams that represent the GUI screen displays. Due to the many permutations of control settings, operating status, channel configurations etc., it is inevitable that these diagrams will look slightly different to those on your control centre.

Anti-aliasing

To make the GUI of the PRO Series as crisp, eye-catching and as intelligible as possible it incorporates an anti-aliasing algorithm to ensure the utmost smoothness of straight lines and curves.

Training

The PRO Series Control Centre Quick Reference Guides, which have been extracted entirely from this manual, provides a useful structured training guide. For more details, see Appendix I "Documentation".

PRO Series user documentation

For a full list of documentation supplied with the PRO Series Live Audio Systems, see Appendix I "Documentation".

PRO Series host software version

This manual is for a PRO Series Control Centre running host software version 1.12 and later.

Warranty and registration

Midas has total confidence in the quality and reliability of this product. To back this up, this product comes with the standard Midas three year warranty.

Please take the time to register your product by completing and returning the registration card or by registering on our website at www.midasconsoles.com.

Service and support

The PRO Series Live Audio Systems are very hi-tech pieces of equipment. We provide superb levels of support and service to give users confidence in Midas digital products.

Chapter 2: PRO Series Live Audio Systems

This chapter gives an overview of the PRO Series Live Audio Systems.

Introducing the PRO3

The PRO3 Live Audio System is an entry-level system that is ideally suited to situations requiring tighter budgets, enabling more touring riders and professional installations to take advantage of Midas' digital features.

The PRO3 Live Audio System has 56 input channels with remote controlled mic preamps, 27 buses and six stereo effects. It utilises the fixed format, 5U I/O rack of the DL251 Audio System I/O and can be fully upgraded to the specification of a PRO6 or PRO9.

I/O box options include the DL351 Modular I/O and DL451 Modular I/O with the full range of module options (DL441 analogue input (mic) module, DL442 analogue output module, DL443 analogue Jack I/O module, DL444 8 analogue mic in and 8 analogue line out module and DL452 AES/EBU input and output module), and also the DL431 Mic Splitter.

Introducing the PRO6

The PRO6 Live Audio System is a mid-range system that is the heart of the PRO Series. It has 64 simultaneous input processing channels with up to 35 discrete mixes in monitor mode. The PRO6 is expandable to 288 inputs and 294 outputs, all of which can be patched/routed on a scene-by-scene basis by the powerful snapshot automation system.

The I/O options include the fixed configuration DL251 Audio System I/O at the stage box end to the DL431 Mic Splitter (24-channel x 5-way), with the full range of module options (DL441 analogue input (mic) module, DL442 analogue output module, DL443 analogue Jack I/O module, DL444 8 analogue mic in and 8 analogue line out module and DL452 AES/EBU input and output module).

Further flexibility can be added to the system by utilising a Klark Teknik DN9650 Network Bridge digital format converter offering MADI and Dante connectivity.

The PRO6 is fully upgradable to the specification of a PRO9.

Introducing the PRO9

The PRO9 Live Audio System is the top of the range system of the PRO Series. It has a massive 88 channel input count with 35 buses. It has dual stage boxes to give the flexibility of up to 200 m apart and 500 m from front of house (FOH). It has the full range of I/O box options (DL251, DL351, DL431 and DL451), each with the full range of module options (DL441 analogue input (mic) module, DL442 analogue output module, DL443 analogue Jack I/O module, DL444 8 analogue mic in and 8 analogue line out module and DL452 AES/EBU input and output module).

Further flexibility can be added to the system by utilising a Klark Teknik DN9650 Network Bridge digital format converter offering MADI and Dante connectivity.

Overview

A PRO Series Live Audio System is a very powerful and flexible audio processing system that provides a complete solution for any audio mixing and signal distribution application in a live sound environment. The PRO Series Live Audio Systems comprise the PRO3, PRO6 and PRO9 and their common features include:

- Dual 'daylight visible' screens with three-way KVM switch.
- XL8-style 'fast zones'.
- XL8-style dual operator 'channel strips'.
- 10 VCAs.
- Six POPulation groups.
- Configurable 'area B'.
- Surround panning, including 5.1, quad and left-centre-right-surround (LCRS).
- Dual redundant Linux control computers.
- Three AES50 ports on the rear of control centre for I/O expansion and XL8 connectivity.
- Eight AES50 ports for stage end of snake for I/O expansion.
- Up to 24 configurable inputs and 24 configurable outputs on control centre (depending on type of I/O cards fitted).
- N+1 redundant, hot-swappable triple power supplies.
- Three-year factory warranty.
- Accessories include: Klark Teknik DN9331 Rapide Graphic Controller, Klark Teknik DN9696 Recorder and Klark Teknik DN9650 Network Bridge.

Despite their compact size, each PRO Series Live Audio System offers a high channel count and exemplary audio performance. They can have up to 104 simultaneous input processing channels, along with eight auxiliary returns and up to 35 discrete mixes (16 auxes, 16 matrices and three masters) in monitor mode, thus giving a total of 41 buses (including the six solos); all of which have EQ and a choice of dynamics options. In addition, each PRO Series Live Audio System has eight on-board effects processors, PEQs (four-band on inputs and six-band on outputs), eight standard (up to 36 maximum) 31-band GEQs, eight configurable stereo effects¹, 5.1 surround panning and comprehensive, easy-to-use routing. PRO Series automation provides up to 1,000 scenes with snapshot save/recall capability and global edit, and show file archiving.

Additional I/O hardware can expand a PRO Series network to up to 288 inputs and 294 outputs with point-to-point routing anywhere within the network, which can then be patched and routed on a scene-by-scene basis via a powerful snapshot automation system.

The PRO Series Control Centre forms the core of each PRO Series Live Audio System. Operation of the control surface is intuitive, unique and easy. Its layout is based on familiar analogue lines to retain that 'analogue' feel. To manage the numerous channels, the control centre utilises VCA/POP groups and colours, and additionally there are various navigational controls that aid quick channel/bus access and selection. A daylight-viewable GUI at the top of the control surface assists operation and provides extra functionality.

In a standard PRO Series Live Audio System, digital system processing (DSP) and system I/O are provided by 19" rack units. Each system has a DL371 Audio System Engine (7U), which is the digital system processing (DSP) engine, whereas the supplied

1. Each can be configured to generate four additional GEQs, making a total of 36 available on the control centre (plus one stereo effect).

I/O unit(s) are dependent on system type. The PRO Series Control Centre and rack units are interconnected by a networked data system, which carries both proprietary control data and open architecture AES50 digital audio, and uses readily available standard cabling and connectors. The PRO Series uses a proven stable Linux operating system. All of the control centre's internal and network routing ("patching") is managed via the graphical user interface (GUI).

You can assign up to 36 1/3 octave KT DN370 graphic EQs, which can be controlled via an optional KT DN9331 Rapide. There are four type of compression on the inputs and five on the outputs.

The PRO Series have easy-to-use routing/patching, redundant power supplies and a modular FPGA processing engine with n+1 redundant module. The DSP engines of the PRO3 and PRO6 can be upgraded to the PRO9 specification. The audio transport system is international AES50 standard. Component hardware connections support redundant cables for copper (option of fibre-optic for PRO6 and PRO9). Each control centre has dual redundant Linux master controllers (MCs), either of which can run the entire system on their own, and they are switchable without loss of audio.

The PRO Series Live Audio System is tolerant of many types of hardware or software failure. To achieve this the system employs dual redundancy, where a key component has an identical redundant spare that is ready to take over should it fail. Other failure scenarios are managed by the N+1 principle, where redundant components form an acceptable fraction of the system.

The Klark Teknik DN9696 Recorder can be used with the PRO Series Live Audio Systems for live multi-track recording and 'virtual' sound check. Optional I/O equipment includes the XL8's DL451 Modular I/O and DL431 Mic Splitter, and the DL251 Audio System I/O and DL351 Modular I/O. Other optional equipment includes the Klark Teknik DN9331 Rapide Graphic Controller for remote GEQ operation.

Key features

Please remember, each PRO Series is not just a console, it's a LIVE AUDIO SYSTEM!

- **High channel count** — up to 80 mixed primary inputs (sourced from up to 288 input locations) and up to 35 output channels.
- **Control centre** — Small and very compact with an exciting but familiar and ergonomic control surface, enhanced by a two-screen GUI.
- **Performance** — Reduced price, scale and features, but still with XL8 audio performance.
- **Operation** — Easy to use with responsive interpolated controls and fast, intuitive human interfaces that combine to produce that familiar *analogue* feel.
 - **User interface (speed and feel)** — VCA groups (console comes to you!); POP groups (console comes to you!); muscle memory (E-zone and D-zone on channel strips, which have paged controls that do not change function); input and output fast zones; electronic colour coding; and dedicated motorised master output faders.
 - **User interface (status visibility)** — Dual daylight-visible screens and integral surface illumination; metering (23 discrete 20-segment LED meters), discrete metering for dynamics, and *all meters all of the time*; "ST" assign switch; and eight channels of key data plus a single channel strip on both GUI screens.
- **Traditional Midas and Klark Teknik audio quality:**
 - **Headroom** — High headroom, which is well behaved, even when *pushed a little too hard*.
 - **Mic amps** — High quality, overload tolerant microphone amplifier per input.
 - **Dynamics** — High quality dynamic processing with traditional *analogue* artefacts. Midas dynamics has four styles on the inputs and five on the outputs.

- **EQ** — Fully interpolated phase shifting EQ for that “Midas” sound.
- **PEQ** — High quality EQ with the “Midas” sound. Each output has a six-band parametric EQ, while the inputs have four bands each. Midas sound quality and ‘feel’ on the EQ’s four filters.
- **GEQ** — Up to 36 Klark Teknik-quality GEQs with unique on-board fast access controller and control from RapidE.
- **Effects** — High quality effects processing with traditional artefacts. Up to eight stereo effects units.
- **Patching** — Unique simple-to-use routing system that lets you carry out all your routing needs and also configure any attached devices via the GUI.
- **Navigation** — VCA-based and other advanced intuitive paging/navigation methods.
- **Automation:**
 - **Snapshots** — Flexible *snapshot* style save and recall of control settings and cross-scene global edit capability.
 - **Showfiles** — USB connectors for show archiving. Showfiles are both forward and backward compatible across firmware versions.
- **Metering** — Comprehensive metering. The GUI can show all of the meters all of the time.
- **Dual operation** — Capable of supporting two-man operation, which is ideal for festival situations.
- **Storable preferences** — Storable user operational preferences to suit specific applications, for example, FOH/MON.
- **Broadcasting** — 5.1 surround panning for broadcast markets.
- **Latency** — Low and managed latency through the system. Minimal latency and fully time aligned.
- **Cabling** — Cat 5e or fibre optic snakes. Standard system has reduced cabling as compared to any other available solution.
- **System design and network:**
 - Integrated open-architecture AES50 digital audio distribution.
 - Up to 100 metres (Cat 5e) or up to 500 metres (optical fibre) of dual redundant connectivity between hardware elements.
 - Automatic integral delay management system — audio outputs time and phase coherent.
 - Flexible, expandible hardware system includes analogue and digital I/O options for flexible system integration.
 - Ethernet TCP-IP and USB tunnelling for third parties.
 - KVM (keyboard, video and mouse) switching on control centre.
 - Fast flexible audio and control system architecture.
 - Modular digital and analogue I/O options.
 - Advanced automation and system operating preferences.
 - PRO Series is flexible and the system can be customised with the needs of the install.
 - VGA outputs for additional screens.

- **Reliability** — High reliability with some redundancy and other back up contingencies.
 - Failure-tolerant of any single failure of hardware or software.
 - Proven, stable Linux operating system.
 - Dual redundant control surface master controllers and N+1 redundant PSUs.
 - Duplicated (N+1) network for redundancy.
 - Control centre has triple redundant power supplies.
 - DL251 Audio System I/O (stage box) has dual redundant power supplies.
 - DL351 Modular I/O (stage box) has dual redundant power supplies and N+1 redundant AES50 connections at the digital interface.
 - DL371 Audio System Engine (stage box) has N+1 (optional) modules with three (N+1) power supply units (PSUs).
 - DL431 Mic Splitter (stage box) has dual redundant power supplies.
 - DL451 Modular I/O (stage box) has N+1 redundant AES50 connections at the digital interface.
- **Support** — 24/7 global telephone support.

The following table shows the differences between the PRO Series systems.

Table 1: PRO Series comparison

<i>Item</i>	<i>PRO3</i>	<i>PRO6</i>	<i>PRO9</i>
Configuration:			
Maximum capacity, giving point-to-point routing anywhere within the network	Inputs = 288 Outputs = 294	Inputs = 288 Outputs = 294	Inputs = 288 Outputs = 294
Primary inputs	48	56	80
Return inputs	8	8	8
Maximum simultaneous mix channels	72	80	104
Number of groups/auxes	16	16	16
... and matrices	8	16	16
... provide these mixes in 'monitor' mode	24	32	32
Mix buses	27	35	35
VCAs	10	10	10
POPulation groups	6	6	6
Effects devices	6	8	8
Maximum Klark Teknik DN370 Graphic Equalisers - with optional DN9331 control	28	36	36
Configurable 'area B'	Yes	Yes	Yes

<i>Item</i>	<i>PRO3</i>	<i>PRO6</i>	<i>PRO9</i>
Standard surface I/O (three configurable card slots): see Table 3 "Standard equipment supply per PRO Series system" on page 16	Yes	Yes	Yes
Stage I/O	DL251 - 48 inputs and 16 outputs, fixed configuration	DL351 - 56 inputs and 8 outputs, configurable I/O	DL351 - 56 inputs and 8 outputs, configurable I/O DL451 - 24 inputs, configurable I/O
Digital snake	100 m bi-directional 192 + 192 channel Cat 5e digital snake (with redundant option)	Dual redundant HyperMac (192 x 192) Cat 5e digital snake included. Fibre-optic connections for optional maximum 500 m snake.	Dual redundant HyperMac (192 x 192) Cat 5e digital snake included. Fibre-optic connections.
Upgradeability	To PRO6 and PRO9	To PRO9	N/A
Shipping	Control centre supplied in shipping crate	Control centre supplied in flight case. 16U flight case supplied for DL371 DSP and DL351 I/O.*	Control centre supplied in flight case. 16U flight case supplied for DL371 DSP and DL351 I/O.*
Additional I/O box options:			
DL251 Audio System I/O	Yes	Yes	Yes
DL351 Modular I/O	Yes	Yes	Yes
DL431 Mic Splitter	Yes	Yes	Yes
DL451 Modular I/O	Yes	Yes	Yes
I/O card options:			
DL441 analogue input (mic) module	Yes	Yes	Yes
DL442 analogue output module	Yes	Yes	Yes
DL443 analogue Jack I/O module	Yes	Yes	Yes
DL444 8 analogue mic in and 8 analogue line out module	Yes	Yes	Yes
DL452 AES/EBU input and output module	Yes	Yes	Yes
Option of 150 m fibre optic cable	No	Yes	Yes

<i>Item</i>	<i>PRO3</i>	<i>PRO6</i>	<i>PRO9</i>
Packing options:			
Control centre flight case	Yes	N/A	N/A
16U flight case for DL371 DSP and I/O	Yes	N/A	N/A
Accessories:			
Klark Teknik DN9331 Rapide Graphic Controller	Yes	Yes	Yes
Klark Teknik DN9696 Recorder	Yes	Yes	Yes
Klark Teknik DN9650 Network Bridge (MADI, Dante, Aviom, Ethersound, CobraNet)	Yes	Yes	Yes

* Packing may vary by territory.

Applications

The PRO Series are the 'work horse' mid- to high-end Midas Digital Console Systems, akin to the 'industry standard' Heritage 3000. Although the PRO Series are designed for the traditional touring live sound environment, they are also ideal for medium-sized theatre, small house of worship installations and broadcast. So, being a truly multi-functional console in the Midas tradition, the PRO Series are suitable for many applications, such as:



- Live sound touring MON or FOH duties.
- Live sound small theatre MON or FOH duties.
- Live sound house of worship MON or FOH duties.
- Live sound broadcast mixer with basic 5.1 surround capabilities and monitoring.

System components

The PRO Series are modular systems, which allows for some variations in physical placement and system size.

The standard PRO Series touring system package is shipped in a single, easily portable flight case, with an equally portable, flight-cased control surface and minimal cabling. The following table lists all of the available equipment options for the PRO Series Live Audio System package.

Table 2: Range of PRO Series equipment supply

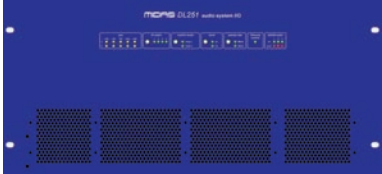
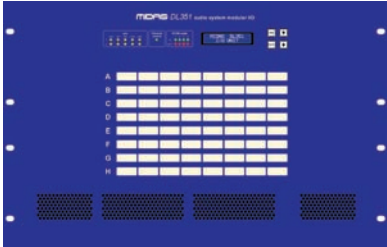
<i>Item</i>	<i>Example</i>
PRO3 Control Centre	
PRO6 Control Centre	
PRO9 Control Centre	
DL251 Audio System I/O This is supplied as a fixed configuration unit with 48 mic/line inputs and 16 outputs.	
DL351 Modular I/O This has eight slots in an 8 x 8-channel format, which provide up to 64 x 64 configurable I/Os.	







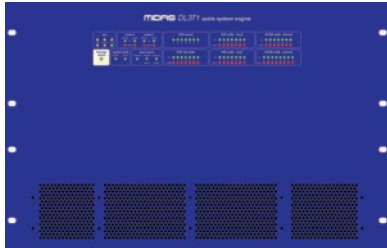

<i>Item</i>	<i>Example</i>
<p>DL371 Audio System Engine This is populated with five cards, the two empty slots being blanked off. (If the optional N+1 redundant DSP module card is fitted, there will be six cards and one empty slot.)</p>	
<p>DL431 Mic Splitter This is a fixed configuration I/O unit that has 24 mic/line inputs in a 5-way split.</p>	
<p>DL451 Modular I/O This gives up to 24 configurable I/Os in a 3 x 8 XLR modular format.</p>	
<p>DL441 analogue input (mic) module This is an analogue mic/line input "I" card.</p>	
<p>DL442 analogue output module This is an analogue output "O" card.</p>	
<p>DL443 analogue Jack I/O module This is an 8-analogue line in and 8-analogue line out "TRS" card.</p>	
<p>DL444 8 analogue mic in and 8 analogue line out module This is an 8-analogue mic in and 8-analogue line out "D Sub" card.</p>	
<p>DL452 AES/EBU input and output module This is an AES/EBU input and output "D" card.</p>	
<p>Interconnecting cable Interconnecting (N+1) rack Cat 5e copper cable</p>	N/A
<p>Interconnecting cable Interconnecting (dual redundant) gigabit HyperMac Cat 5e copper cable, 100 m long</p>	N/A
<p>Mains cable</p>	N/A

Table 3: Standard equipment supply per PRO Series system

<i>Item</i>	<i>PRO3</i>	<i>PRO6</i>	<i>PRO9</i>
Control centre	Three slots in rear panel populated with: DL443 module and two blank panels.	Three slots in rear panel populated with the following modules: DL442, DL443 and DL452	Three slots in rear panel populated with the following modules: DL442, DL443 and DL444
Control centre supplied in ...	Shipping crate	Flight case	Flight case
DL251 Audio System I/O	Yes	No	No
DL351 Modular I/O	No	Populated with seven DL441 analogue input modules (56 main inputs) and a DL442 analogue output module. There are a total of 56-off XLR mic/line inputs provided on the system.	Populated with seven DL441 analogue input modules (56 main inputs) and a DL442 analogue output module
DL371 Audio System Engine	Populated with five cards, the two empty slots being blanked off. (If the optional N+1 redundant DSP module card is fitted, there will be six cards and one empty slot.)	Populated with five cards, the two empty slots being blanked off. (If the optional N+1 redundant DSP module card is fitted, there will be six cards and one empty slot.)	Populated with five cards, the two empty slots being blanked off. (If the optional N+1 redundant DSP module card is fitted, there will be six cards and one empty slot.)
DL431 Mic Splitter	No	No	No
DL451 Modular I/O	No	No	Populated with 3-off DL441 input modules
DL441 analogue input (mic) module	No	7-off in DL351	7-off in DL351, 3-off in DL451
DL442 analogue output module	No	1-off in DL351, 1-off in PRO6 Control Centre	1-off in DL351, 1-off in PRO9 Control Centre
DL443 analogue Jack I/O module	1-off in PRO3 Control Centre	1-off in PRO6 Control Centre	1-off in PRO9 Control Centre
DL444 8 analogue mic in and 8 analogue line out module	No	No	1-off in PRO9 Control Centre
DL452 AES/EBU input and output module	No	1-off in PRO6 Control Centre	No
Rack units supplied in ...	14U rack, in a flight case	16U rack, in a flight case (packing may vary by territory)	16U rack, in a flight case (packing may vary by territory)
Interconnecting (N+1) rack Cat 5e copper cable	4-off	4-off	4-off

<i>Item</i>	<i>PRO3</i>	<i>PRO6</i>	<i>PRO9</i>
Interconnecting (dual redundant) gigabit HyperMac Cat 5e copper cable, 100 m long.	2-off	2-off	2-off
Mains cable	8-off	8-off	8-off

FOH and MON

Each PRO Series can be used as a front of house (FOH) or stage monitor (MON) system.

System buses

The PRO Series has comprehensive system buses to suit demanding applications, comprising:

- 6-off solo buses, routable from all locations and allowing for dual operator and 5.1 use.
- 3-off master buses, routable from the mic/line inputs (up to 80), eight aux inputs and 16 aux buses.
- Up to 16-off matrix buses, routable from the mic/line inputs (up to 80), eight aux inputs, 16 aux buses and three master buses.
- 16-off aux buses, routable from the mic/line inputs (up to 80) and eight aux inputs.

All of the bus routings provide simultaneous and time aligned mixing of all the sources, which will be defeatable for minimum latency requirements.

For monitor mixing, the master, matrix and aux buses can all be routed directly from the input channels, with independent level controls providing up to 35 monitor mix buses.

For traditional FOH sub group mixing, any (or all) of the aux buses can change to operate post-channel fader and pan (that is, aux gain fixed at unity).

Auxiliary inputs have two modes of operation: effects return and input channel. In input channel mode (default) they will have aux, master and matrix routing, insert points and EQ (like regular inputs channels), but no dynamic capability. They are controlled like regular inputs from the input bay and channel strip, and are time aligned to the stage like regular input channels. In effects return mode the channels have routing to matrix and masters only and no insert or dynamic capability. They are controlled from the aux return area and time aligned to the effects engines.

Mix matrix

Ultimately, the mix matrix defines the capability of each PRO Series Control Centre. Probably the best way to imagine the mix matrix is to think of an analogue console layout, where inputs run vertically and buses run horizontally. A mix matrix is usually defined as the number of buses and the quantity of simultaneously-mixable inputs there are per bus. The following diagrams illustrate the capability within each PRO Series Control Centre.

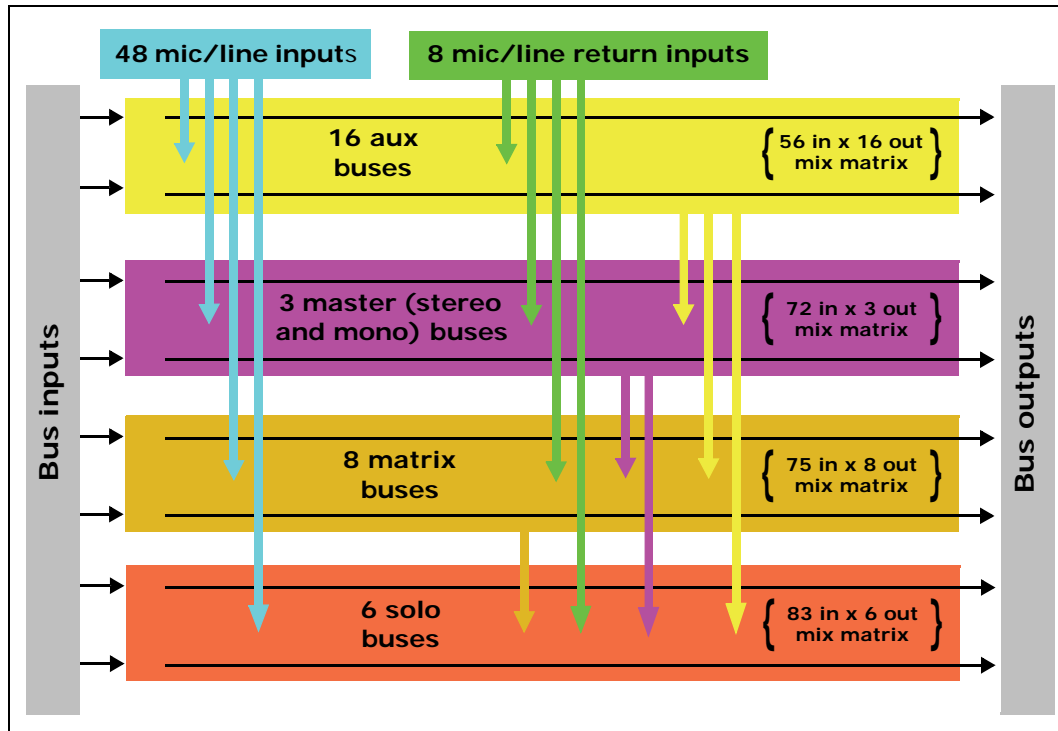

Figure 1: PRO3 mix matrix

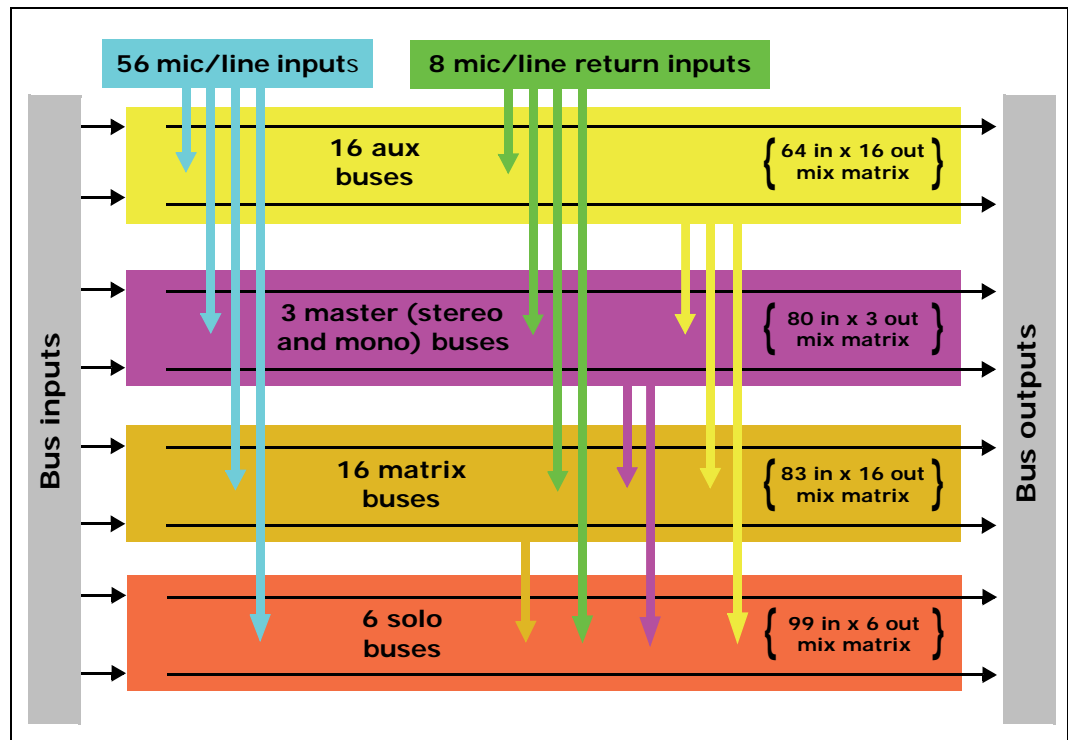

Figure 2: PRO6 mix matrix

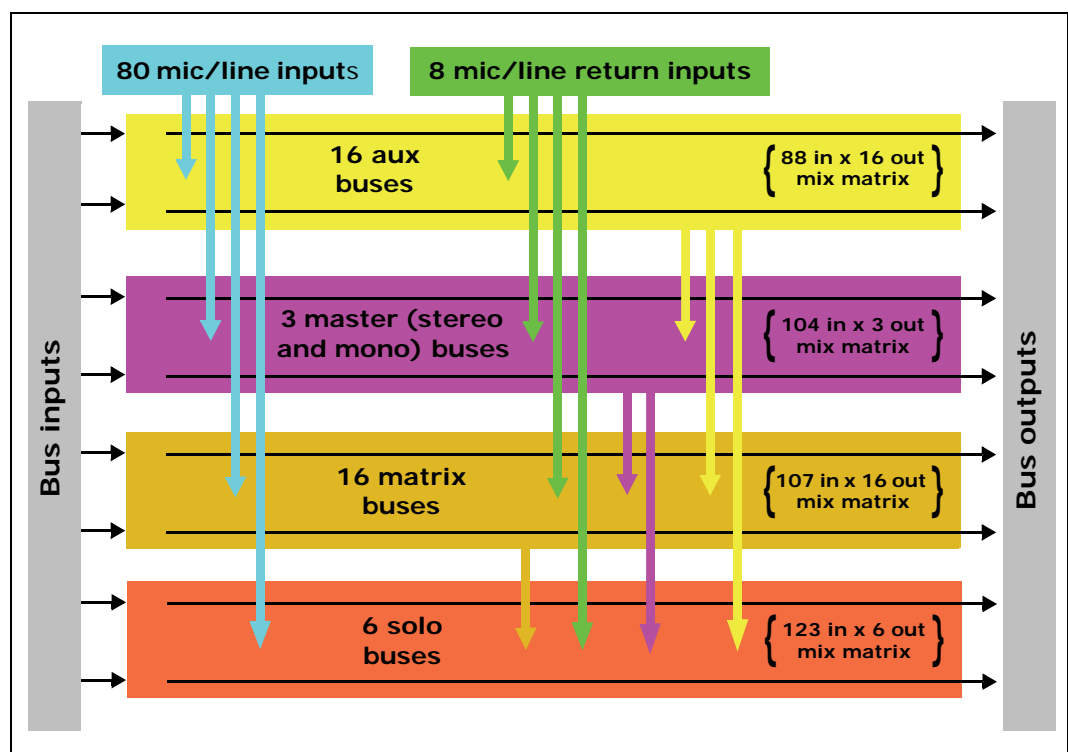

Figure 3: PRO9 mix matrix

Processing

Although the control centre system allows for considerable insertion of external processing, it also embodies more than enough internal high quality processing to eliminate the need for this, in the interests of simplicity and reduced overall system size, weight and cost.

Processing components

The processing available is:

- Up to 80 x 12 or 24dB/oct. high pass filters.
- Up to 80 x 6 or 12dB/oct. low pass filters.
- 115 compressor/limiters with side chain filtering and multiple operating “signatures”.
- Up to 80 gates with side chain filtering.
- Up to 80 x 4-band parametric EQs with multiple shelf “modes”.
- Up to 35 x 6-band parametric EQs with hi/lo pass modes.
- 8 assignable 31-band graphic EQs.
- Up to 36 additional 31-band graphic EQs that utilise effects processor digital signal processing (DSP), reducing the available effects quantity stated below.
- Up to 8 effects processors selectable from reverb, delay, flanger, phaser, dynamics, compressor and pitch shifter.

Input channel processing

Each of the 80 (maximum) full-function input channels has:

- Analogue and digital gain.
- Phase reverse switch.
- Input delay.
- Swept high pass filter with choice of two filter slopes.
- Swept low pass filter with choice of two filter slopes.
- Frequency-conscious compressor with choice of four compression styles.
- Frequency-conscious noise gate with external side chain.
- Insert point.
- Treble EQ filter with choice of four filter types.
- Parametric hi-mid EQ filter.
- Parametric lo-mid EQ filter.
- Bass EQ filter with choice of four filter types.
- Routing via level controls to 32 mix buses.
- Routing via pan control to left and right master buses.
- Routing to mono master bus.
- Panpot (SIS™).
- Direct output.

Each of the eight auxiliary inputs has:

- Input gain.
- Source from internal FX or external input.

- EQ.
- Fader.
- Panpot (SIS™).
- Routing via level controls to the matrix buses (8 or 16).
- Routing via pan control to the left, right and mono master buses.

Mix channel processing

Each of the 16 auxiliary mix buses has:

- Subgroup, auxiliary or mix minus modes.
- Dual mono or stereo pair modes.
- Six-band PEQ.
- Optional 31-band GEQ (replaces PEQ).
- Frequency-conscious compressor with choice of five compression styles.
- Insert point.
- Routing via level controls to the matrix buses (8 or 16).
- Routing via pan control to the left, right and mono master buses.
- Direct input.

Each of the matrix buses (8 or 16) has:

- Six-band PEQ.
- Optional 31-band GEQ (replaces PEQ).
- Five-mode frequency-conscious compressor with soft clip limiter and external side chain.
- Insert point.
- Direct input.

Output channel processing

Each of the matrix buses (8 or 16) has:

- Six-band PEQ.
- Optional 31-band GEQ (replaces PEQ).
- Five-mode frequency-conscious compressor with soft clip limiter and external side chain.
- Insert point.
- Direct input.

Each of the three master output buses has:

- Six-band PEQ.
- Optional 31-band GEQ (replaces PEQ).
- Five-mode frequency-conscious compressor with soft clip limiter and external side chain.
- Insert point.
- Direct input.
- Routing via level controls to the matrix buses (8 or 16).

Effects processing and GEOs

The PRO Series contains six or eight mono Klark Teknik (KT) GEOs and seven effects processors as standard.

The seven effects processors can be freely chosen from:

- KT DN780 reverb.
- Delay.
- Flanger.
- Phaser.
- Pitch shifter.
- SQ1 dynamics.
- Stereo 3-band compressor.

The six or eight mono KT GEOs can be patched into any output. There are many patching options for the effects processors:

- Assign to any insert send/return.
- Assign to any pool, in or out.
- Assign FX out to aux return.
- Assign FX in to aux send (post-fade).
- Assign FX out to bus direct in.
- Assign FX in to channel direct out.

A Klark Teknik DN9331 RAPIDE motorised fader GEO controller can be used with the PRO Series. This unit provides rapid adjustments of the graphics with real hardware, and not a mouse and screen. The graphic channel is selected either by the solo button (solo tracking system (STS™)) on the PRO Series Control Centre or by buttons on the DN9331 itself.

Audio physical connections

The maximum total number of physical analogue XLR connections possible on a PRO Series Live Audio System is 288, plus the six local monitor outputs, talkback line out, talk line in and talkback mic in on the rear of the control centre. The 288 configurable connections can be any combination of inputs and outputs, in multiples of eight of each type.

The maximum number of 288 configurable I/O can be increased up to 576 if a combination of different types of I/O card used. The five available card types are DL441, DL442, DL443, DL444 and DL452 (see Table 2 “Range of PRO Series equipment supply” on page 14). Any three of these cards can be fitted directly into the rear of a PRO Series Control Centre, and the remainder are fitted in the configurable I/O boxes.

All of the configurable I/O are freely routable on a scene-by-scene basis.

Surround capabilities

Theatres and broadcast have differing requirements for surround and both are catered for in the PRO Series.

Conventional stereo and SIS™ panning is assignable on a channel-by-channel basis (channel one can be in stereo, while channel two can be in SIS™), as follows:

- Stereo left–right routing to master buses.
- SIS™ left–right–centre routing to master buses.

Three additional surround modes operate as follows:

- **Quad** Left – Right – LS – RS routing to matrices 1, 2, 5 and 6.
- **Surround** Left – Right – Centre – Surround routing to matrices 1, 2, 3, 5 and 6.
- **5.1 surround** Left – Right – Centre – Sub – LS – RS routing to matrices 1, 2, 3, 4, 5 and 6.

Network

The MidasNET network of the PRO Series utilises the physical connectivity of Ethernet (EtherCon® connectors and Cat 5e/copper cable), but replaces its data protocol with AES50 protocol (implemented as SuperMac) and the HyperMac high capacity system, which are more suited to high quality, low latency audio distribution. The use of the AES standard allows straightforward interfacing with any third party hardware that also utilises this connection.

MidasNET connections carry digital audio, control data and standard Ethernet traffic bi-directionally down a single cable. Cat 5e cable is used for the 'local' connections and the single digital 'snake' (equivalent to a 384-channel analogue multi-core) between control centre and DL371 Audio System Engine. The combination of audio, control, clock and third party Ethernet data in a single network means that the hardware interfaces on a single RJ45 connection.

All system connections are duplicated for full dual redundancy.

Reliability (redundancy)

All critical system connections and most components incorporate integral backup and recovery strategies such as redeployment of resources, N+1 redundancy or dual redundancy etc. A modular approach to software, hardware and physical construction also aids reliability and simplifies servicing. The following lists some examples:

- The DL371 Audio System Engine incorporates N+1 redundant power supplies and five modules, with the capability to fit an optional sixth spare module. The standard failure recovery for modules will be redeployment of critical roles typically causing loss of some less important inputs. With the optional sixth module fitted, the system will operate as N+1 and there will be no loss of function after redeployment.
- The router is contained in the same rack and incorporates dual HyperMAC connections in and out.
- The control centre contains dual redundant master controllers, dual GUI screens and N+1 redundant power supplies.
- All I/O units incorporate dual redundant power supplies, and the DL351 and DL451 are modular in blocks of eight to limit the potential for total audio connection failure.

This resilience strategy provides high reliability performance at a reasonable cost because it is designed in from the start and not as an afterthought.

Control software

The operating system of the PRO Series is Linux, which is an open-source, stable, proven operating system (OS). Linux is used in many mission-critical applications worldwide and has allowed Midas' software engineers to write a ground-up system that contains no 'hidden' or unused code. This has resulted in an efficient, compact application, which is quick in operation, quick booting and comparatively easy to debug.

Two copies of the master control software run on separate processors to provide resilience to failure.

GUI

The PRO Series has two, daylight-viewable, TFT screens that provide fast zone and channel strip status indication. Although any screen can display any information, in the standard configuration, screen information relates to module location. So, the mix bay screen displays the channel strip and fast zone (12 inputs and 16 outputs), while the master bay screen displays the channel strip, input fast zone (four inputs) and all meters. The master bay screen is also generally used for automation, effects, GEOs, third party screens etc., although this is dependent on the current application (concerts will probably be different to theatre) and also operator preference.

The screens are controlled from the primary navigation zone at the bottom of the master bay via two trackballs. A USB keyboard (supplied) is used for text editing.

System card expansion

Additional digital I/O format options will be available later, for example, MADI.

Console linking

You can link two PRO Series Control Centres together. Just connect an AES50 cable from a spare AES50 port on one router to a spare port on another, and then configure them via the “Generic AES50” connections option in the GUI menu’s **Patching** screen.

Integration of third party hardware/software

The PRO Series network includes the capability to interface any third party hardware that uses AES/EBU or AES50 digital audio, or a standard analogue audio interface.

Each PRO Series AES/EBU input and output has a sample rate converter. Synchronisation to external AES3 interfaces can be:

- Global - via inputs on the routers.
- Local to each input.
- Local to each output (synchronisation to adjacent local output).

Multiple local connections can be at different sample rates.

The use of the AES50 protocol for the transmission of digital audio means that any third party digital audio hardware that features this connection can be connected to the Midas network, and will transfer audio to and from the Midas hardware without any additional interfaces or converters (provided it runs in TDM 96kHz mode). This will be particularly useful as the protocol gains acceptance with recording and playback devices, loudspeaker controllers, audio networking systems, digital amplifiers etc.

PC or MAC computers can use the Ethernet tunnel in the MidasNET system, and can communicate with other computers on the network.

The PRO Series Control Centre features an external video for both screens, and the master bay GUI screen (on the right) also has a three-way KVM switch. Control centre views can be routed to external monitors, and external video sources can be displayed on the control centre.

The KVM switch facilitates the control of three external computers via the screen, trackball and keyboard of the control centre. This is hugely important and means that third party systems can be controlled from within the PRO Series Control Centre without having to move your head to look at screens placed off to one side. *It also means that there is no need to find somewhere to put multiple keyboards and mice.* Examples are:

- Netmax (AES/EBU audio link initially and CobraNet™ when the 48kHz I/O module is available on PRO Series).
- IRIS (for example, for RL amps).

- Wireless mic controllers.
- Your email.
- DVD movies.

Chapter 3: About The Control Centre

This chapter introduces you to the control centre and provides a brief hardware description.

Overview of the control centre

The control centre has a combined control surface and GUI that provide an array of easy-to-use controls for the precise manipulation of audio.

The control centre is of modular construction and is built on a robust Midas steel frame chassis similar to those used for established Midas analogue products. The frame houses three full size bays with a smaller one on the right. All of the bays are controlled from a single processor and, collectively, provide the primary mixing needs of the engineer.

All associated power supplies, computer motherboards, memory, graphics cards etc. are housed within the control centre, which also contains a digital audio router box that supports local FOH (insert) I/O connectors on the rear panel. Substantial forced air-cooling is provided by a bulkhead and large (but slow moving) internal fans. These produce very low noise, suitable for seated areas theatres and concert sound.



Typical control centre

Externally, the control centre has three main areas: control surface, GUI and rear panel. The control surface is populated with instantly recognisable controls that are logically distributed in major sections. The GUI, which comprises two screens at the top of the centre bays, enhances operation by providing visual representations of the control surface and also gives you extra functionality. The rear panel provides all of the control centre and network connectivity, and houses the mains power sockets and isolator switch.

Being of modular design, the overall form and shape of the control centre is similar to Midas' flagship XL8. The control surface is split into bays, each one containing a flat fader tray and shallow raked control area. The centre bays also have a third area that houses a steep-raked display screen.

Multiple hardware fault types are tolerated by the control centre without loss of audio control due to the dual redundancy and N+1 methods incorporated in the system. This is further helped by the modular nature of the bays and GUI independence. Either of

the GUI screens can be used to operate the whole control centre, even if *none* of the control surface hardware is working. The unit offers the facility of universal input, N+1 redundant power supplies with three latching mains connectors.

Bay and GUI layout

The control centre has four discrete bays that house the following control surface controls:

- **Input bays (12-channel and 4-channel)** — two input bays provide fast access to input faders and important signal processing controls.
- **Mix bay** — provides access to outputs and groups, a detailed processing controller (all channels) and navigational controls.
- **Master bay** — provides access to the master output mixes, monitor (A and B) faders, automation, comms control, assignable effects control, and another set of detailed processing and navigational controls.

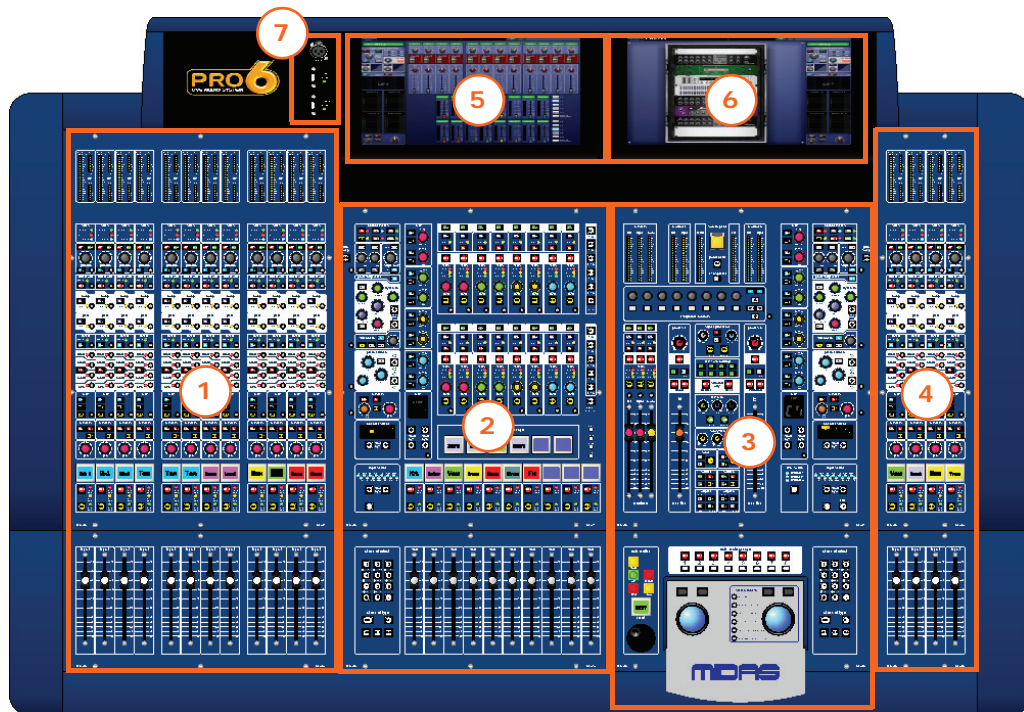

- | | | |
|---------------------------|--------------------------|--------------------------------|
| 1 Input bay (12-channel). | 4 Input bay (4-channel). | 7 Talk mic and USB connectors. |
| 2 Mix bay. | 5 Mix bay GUI screen. | |
| 3 Master bay. | 6 Master bay GUI screen. | |

Figure 4: Bay and GUI layout of a typical control centre

Two GUI display screens at the top of the central bays provide extensive screen support (standard configuration) and extra functionality for the channels and buses. For example, when mixing or processing. They also facilitate the use of the GUI menu, which gives you access to the many powerful features of the control centre, such as patching, effects, GEOs, diagnostics etc.

Control surface

The control surface is divided into areas whose function is, largely, dependent on bay location. Each bay has assorted control elements with local feedback and/or support from the two centrally located GUI display screens. The screens can be remoted via external VGA connections, and third party systems can also be viewed/controlled via an integrated KVM switch on the rear panel.

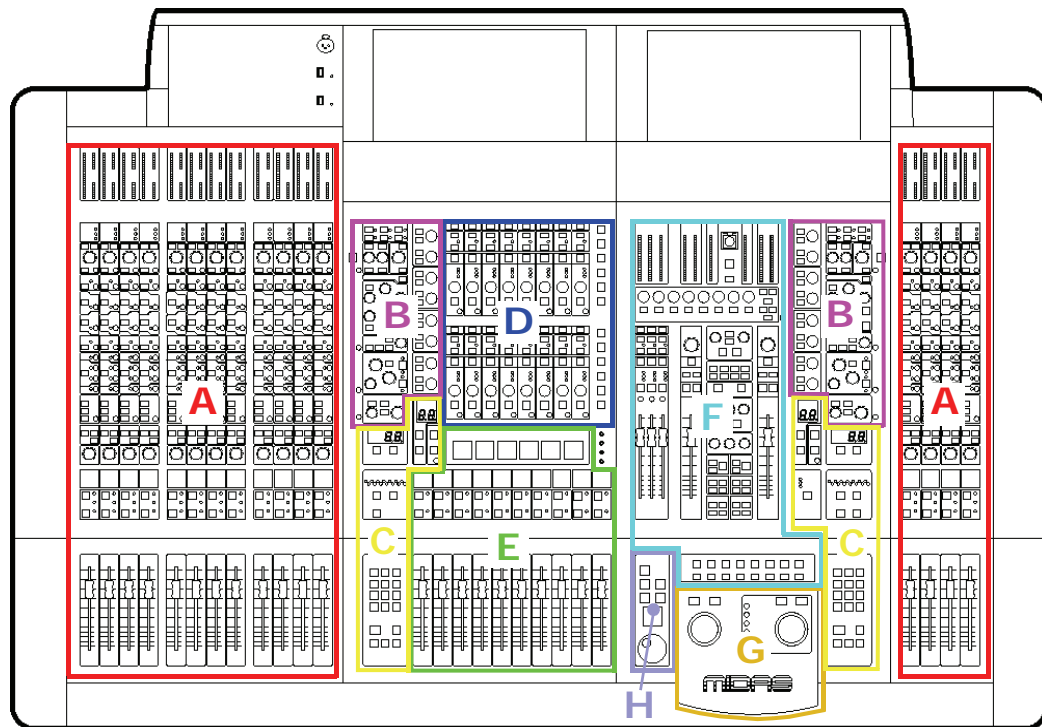

A — **input fast zone:** 16 input fast strips across the 12-channel and 4-channel input bays provide the operator's 'must have now' controls.

B — **channel strip and mixes:** processing areas, such as the D-zone (dynamic), E-zone (EQ) and mix controls, provide a more comprehensive control by allowing detailed adjustments to a single channel's audio parameters.

C — **channel and bus navigation zone:** sections for channel and bus navigation and selection. For details, see Chapter 7 "Navigation".

D — **output fast zone:** 16 output fast strips can be used for mixing and processing aux, return, matrix and master channels. Navigation and flip buttons are on the right of the output fast strips.

Figure 5: Main areas of the control surface

E — **VCA and POP groups:** VCA faders and POP group sections.

F — **miscellaneous:** master channel strips, A and B signal path monitoring, communications, I-zone, surround monitoring and mute groups.

G — **primary navigation zone:** trackballs for mix and master bay GUI screen control, and a screen access panel (between trackballs) for direct access to GUI menu options.

H — **automation:** scene store/recall and system edit.

During show time the screen functions that require fast access are controlled by control knobs, pushbutton switches, faders etc. More complex functions that do not require this fast access are controlled by the trackballs and navigational keys. A keyboard integral to the flight case is used for text entry via the master bay GUI screen. An external USB keyboard can be used to operate the mix bay GUI screen.

The choice of controls provided by each bay type are prioritised by access time importance. Fast zone areas, which contain fast strips, give instant access to specific functions across the bay, and channel strips give greater control of the selected fast strip.

GUI

The GUI comprises two screens that provide a pictorial representation of the control surface layout so that its displays are easy to follow at a glance. Not only does it reflect what is happening on the control surface, but it also provides extra functionality via a GUI menu. This menu provides access to all the screens that you will require to set up, configure, manage and operate the entire control centre, all from a single drop-down list of easy to follow options.

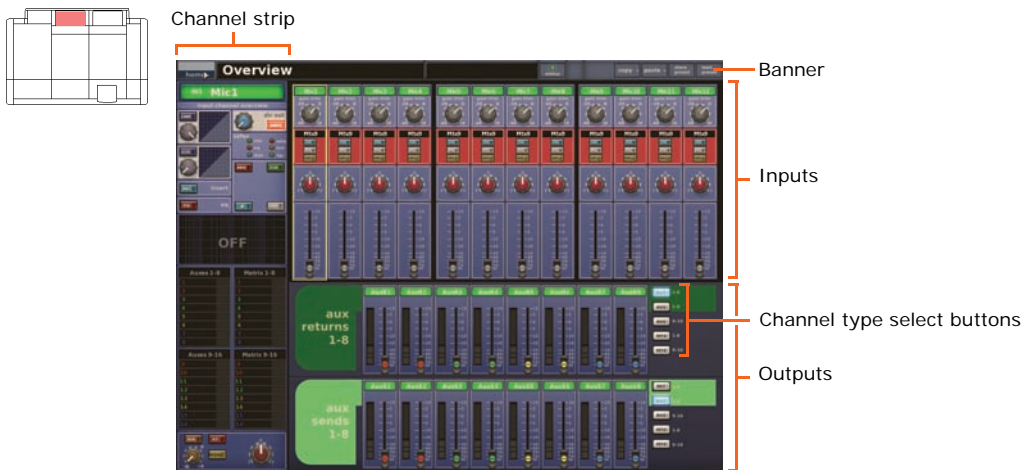
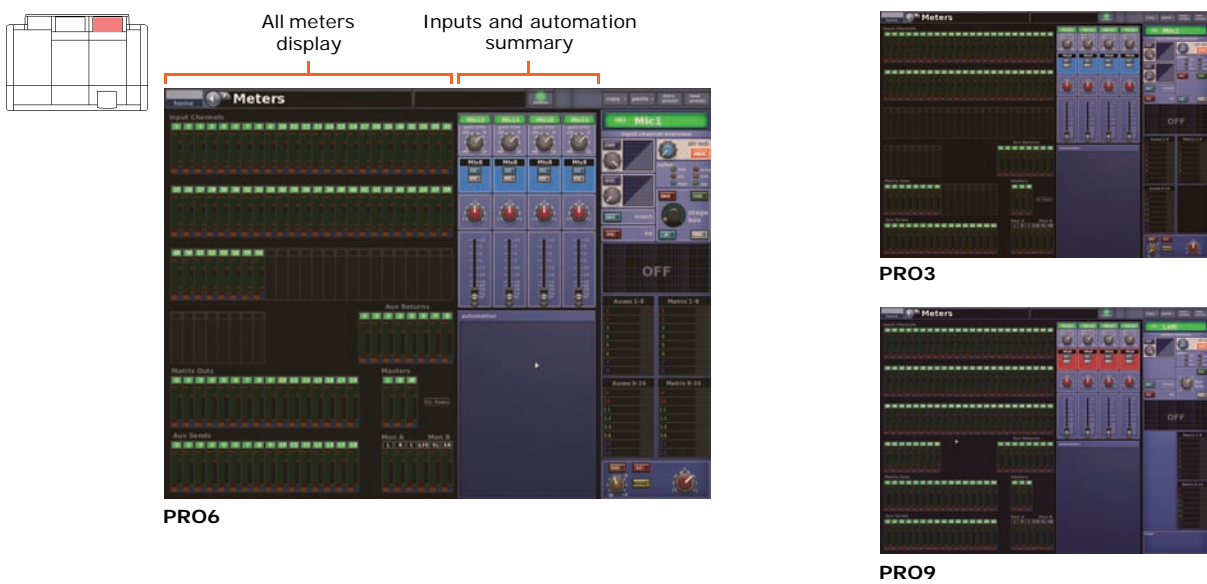

Figure 6: Typical **Overview** screen (default of the mix bay GUI screen)



Typical **Meters** screen with no show loaded (default of the master bay GUI screen)

Each GUI screen has its own default display, although either is selectable via the GUI main menu. The **Overview** screen displays 12 inputs and two sets of eight outputs, and the **Meters** screen shows all the meters, four inputs and a summary of the automation. Both screens have a banner at the top, which is constantly displayed, and a channel strip down the outermost side.

The channel strips have a similar function to the ones on the control surface (see Figure 5 on page 29), but provide extra functionality. Each displays an 'overview' of the associated selected channel, which is divided into specific sections that provide access to processing areas.

Front and rear panel connections

The control centre has connector panels on both the front and rear, and also to the left of the mix bay GUI screen.

The connector panel to the left of the GUI has an XLR socket and two USB sockets for connecting a talk mic and USB devices, respectively. For example, you can connect a USB memory stick for show file backup and transfer, or a USB keyboard for text editing on the GUI. The top USB socket is associated with the mix bay and the bottom one with the master bay.

There are two panels at either end of the front of the control centre, under the armrests. Each has a keyboard and phones socket. The left and right keyboard sockets operate the mix and master bay GUI screens, respectively. The phones socket in the left panel is for the monitor A section and the other one is for monitor B.

A connector panel on the rear of the control centre has three main sections (see below). On the left are three mains power inlet and ventilation assemblies, with a DC power switch above. The mid-section contains connections for the audio, network, communications, intercoms, synchronisation, external remote devices and peripheral devices. The section on the right is the user-configurable modular I/O section.

The modular I/O section can house up to three of any of the following I/O modules in any combination: DL441 analogue input (mic) module; DL442 analogue output module; DL443 analogue Jack I/O module; DL444 8 analogue mic in and 8 analogue line out module and DL452 AES/EBU input and output module. This gives a maximum of 24 inputs and 24 outputs, if the appropriate cards are fitted.



Rear view of the control centre

For more information, see Chapter 29 "Panel Connections" on page 265.

External interfaces and peripheral devices

Various devices can be used with the PRO Series, such as:

- **External USB mouse** Instead of using the primary navigation zone to operate either of the GUI screens, you can use an external USB mouse. This can be plugged into any of the USB connectors on the PRO Series. The USB mouse behaves in the same way as any PC mouse. For more information, see “Using an external USB mouse” on page 244.
- **External USB keyboard** A USB keyboard can be used to operate either of the GUI screens. For more information, see “Using an external USB keyboard” on page 244.
- **MIDI** Standard 5-pin connectors are housed in the rear panel for use as MIDI in, out and through ports. These are fitted on the I/O units and, therefore, are available at both the FOH and the stage locations.
- **USB** Host and slave USB ports are provided on all units and are, therefore, available at the FOH and stage locations. In addition, the PRO Series provides USB host ports (left of GUI screens) for keyboard, mouse and removable storage (memory stick).
- **External monitor** The control centre has high density D-type connectors on the rear panel of the PRO Series Control Centre that carry VGA signals for external monitor connection. For more information, see “Using an external monitor” on page 245.
- **HELIX auto solo** Provided by means of the Ethernet connections on the routers. Solo tracking system (STS) is only available by using a Klark Teknik HELIX RapidE. The console sends solo messages to the RapidE, which then pages to the console.
- **Remote GEQ operation** A Klark Teknik HELIX RapidE can be used to remotely control the GEQs of the PRO Series Control Centre.
- **Network inter-operability** A port on the router is for general ‘rest of the world’ Ethernet traffic. This port is isolated from the PRO Series Control Centre’s Ethernet traffic by a routing table gateway mechanism within the router itself.

Mix buses

To help reduce latency the PRO Series has only four time zones for the primary channel types, with the interconnecting buses being restricted to the intervening time. The time zones and their channel associations are as follows:

- **First time zone** Input channels, including aux inputs set to input channel mode.
- **Interval between first and second time zones** Aux bus.
- **Second time zone** Aux Channels, including aux inputs that are set to effects return mode.
- **Interval between second and third time zones** Master bus.
- **Third time zone** Master outputs.
- **Interval between third and fourth time zones** Matrix bus.
- **Fourth time zone** Matrix outputs.

This differs from traditional analogue consoles, where it is often possible to mix four or five times through a system, as latency is not an issue. However, this system has the advantages of being able to route directly from inputs to matrix output — one bus to another — and offering more flexible bus types (stereo, mono, aux, sub, mix minus etc.).

In this system, all inputs are automatically time aligned, so there is no comb filtering, which is often a problem with other digital consoles.

For details of the bus types and their options, see Table 24 “Definition of primary buses” on page 417.

Automation

The automation system can store and recall up to 1000 snapshot scenes. These contain the setting values for every control on the control centre (excluding some of the monitor section). Scene recall (and store) can be ‘scoped’ such that only the areas that you want to recall (or store) are affected, while all other controls remain in their current state.

The PRO Series can also recall/store operational preferences, so that its operation can be configured to suit a particular application. For example, you can choose whether or not to navigate screens on the ‘touch’ of controls, or as part of snapshot recall.

For theatre applications, channel settings can be recalled (across all scenes) from a library of presets. This complexity allows a generic show to cope with differing performers on a night-by-night basis, which is common in theatres.

Automation is powerful, but also dangerous, so the PRO Series has operator lock/unlock. Therefore, accidental changes during control centre operation are extremely unlikely.

MIDI and GPIO input/output are provided, as well as the ability to fire and respond to contact closures per scene.

The ‘next’ LCD button has been positioned close to the VCA faders and has been purposely designed so as to be distinct from other functions.

Processing elements

For details of the processing elements of the PRO Series, see “Processing” on page 20 and “PRO Series main processing functions” on page 364.

Getting Started

Chapter 4: Setting Up The System

This chapter shows you how to set up a live audio system to its default configuration.

Note: *If you want to set up the system using a configuration other than the default, please contact Midas Technical Support for details.*

Initial set-up procedure

Initial system set-up basically comprises:

- Unpacking and checking the equipment — see “Unpacking the equipment” on page 37.
- Making up a rack — see “Making up a rack” on page 37.
- Connecting up the equipment — see “Wiring instructions” on page 38.
- Powering the equipment — see “Powering the system” on page 42.
- Initial patching — see “Setting up the I/O rack devices” on page 92. **It is important to set up the type of snakes connected in the system.**
- Configuring the rack unit(s) — see “Setting up the ID of the unit(s)” on page 44.

Unpacking the equipment

After carefully unpacking the equipment, save all packing materials, as they will prove useful should it become necessary to transport the equipment later.

Inspect the equipment carefully for any sign of damage incurred during transportation. It has undergone stringent quality control inspection and tests prior to packing and was in perfect condition when it left the factory. However, if the equipment shows any signs of damage, notify the transportation company without delay. Only you, the consignee, may institute a claim against the carrier for damage during transportation.

Making up a rack

In the standard supply, the rack supplied with the your system is fully fitted with the DL371 Audio System Engine unit and the I/O unit(s) appropriate for your system. However, should you wish to re-configure the system to suit your own needs, take note of the rack requirements as detailed in the following subsection.

Outboard equipment rack requirements

To ensure the correct installation and function of the outboard equipment, any rack has to meet the following general requirements:

- **Shock mounting (for non-installation environments)** The rack must provide adequate shock protection of the units it houses by incorporating appropriately-designed shock protection methods. For example, a foam-suspended rack or a frame suspended on anti-vibration mounts.
- **Ventilation** The PRO Series rack units have been designed such that their internal ventilation airflow is drawn in through the front of the unit and expelled through the rear. To facilitate this, rack design must ensure that cool air can flow freely through the rack in the same direction, that is, in through the front of the rack and out

through the rear. Situations where the air flows in a circular direction around and through a PRO Series unit **must** be prevented. Midas recommends that racks with fully opening front and rear doors are used.



Caution!

Never combine units in the same rack that have been designed for a ventilation air flow direction other than that designed for the Midas units. To avoid this, we recommend that any non-Midas units are housed separately.

- **Rack mount supports** Always secure the rear of the PRO Series units to the rack via their rear rack mount support brackets. These brackets are fitted to every PRO Series unit and are recommended for use in touring applications. The rack mount support fixing hole centres are at a depth of approximately 395 mm from the front panel.

Note: The rack mount support fixing hole centre depth from the front panel of the DN9696 Recorder may be slightly different.

- **Handles on rack case** You must ensure that there are sufficient external handles fitted to the rack casing to enable the rack to be manoeuvred easily and safely, and by the number of personnel suitable for the task. Also, these handles must be fit for purpose.
- **Clearance at rear of units** Ensure an adequate clearance at the rear of the units to provide sufficient free space to enable the cables to achieve their minimum bend radius.
- **Securing the cables** We recommend that the cables at the rear of the units be tidied using lacing bars and cable ties. This should provide optimum access to the rear of the units for connecting other cables, switching the units on/off etc., and also to give maximum visibility of the units' LEDs for determining communication status, link status, condition of audio etc.

Note: The above requirements also apply to any other Midas and Klark Teknik units, such as the DL431 Mic Splitter.

Wiring instructions

Important:

The control centre and all of the DLnn1 units have Volex locking type plugs fitted on their supplied mains cables, which plug into their mains IEC connectors. When fitted properly the Volex plug locks into place, preventing it working loose, or being inadvertently knocked loose or pulled out. For details of how to fit/remove a Volex plug, see "Power" on page xvii.

Basically, to connect the system equipment together all you have to do is to connect the control centre to the DL371 Audio System Engine using the Cat 5e or fibre optic snake; the racks units should already be connected together when you receive them.

>> To connect the PRO Series Control Centre to the DL371 Audio System Engine

- 1 At the rear of the PRO Series Control Centre, connect the fibre-optic or copper snakes to the **optical** or **copper** connectors, respectively, in the **snake X** and **snake Y** sections.
- 2 At the rear of the DL371 Audio System Engine, connect the two snakes to the appropriate connectors (**optical** or **copper**) in the **snake X** and **snake Y** sections.

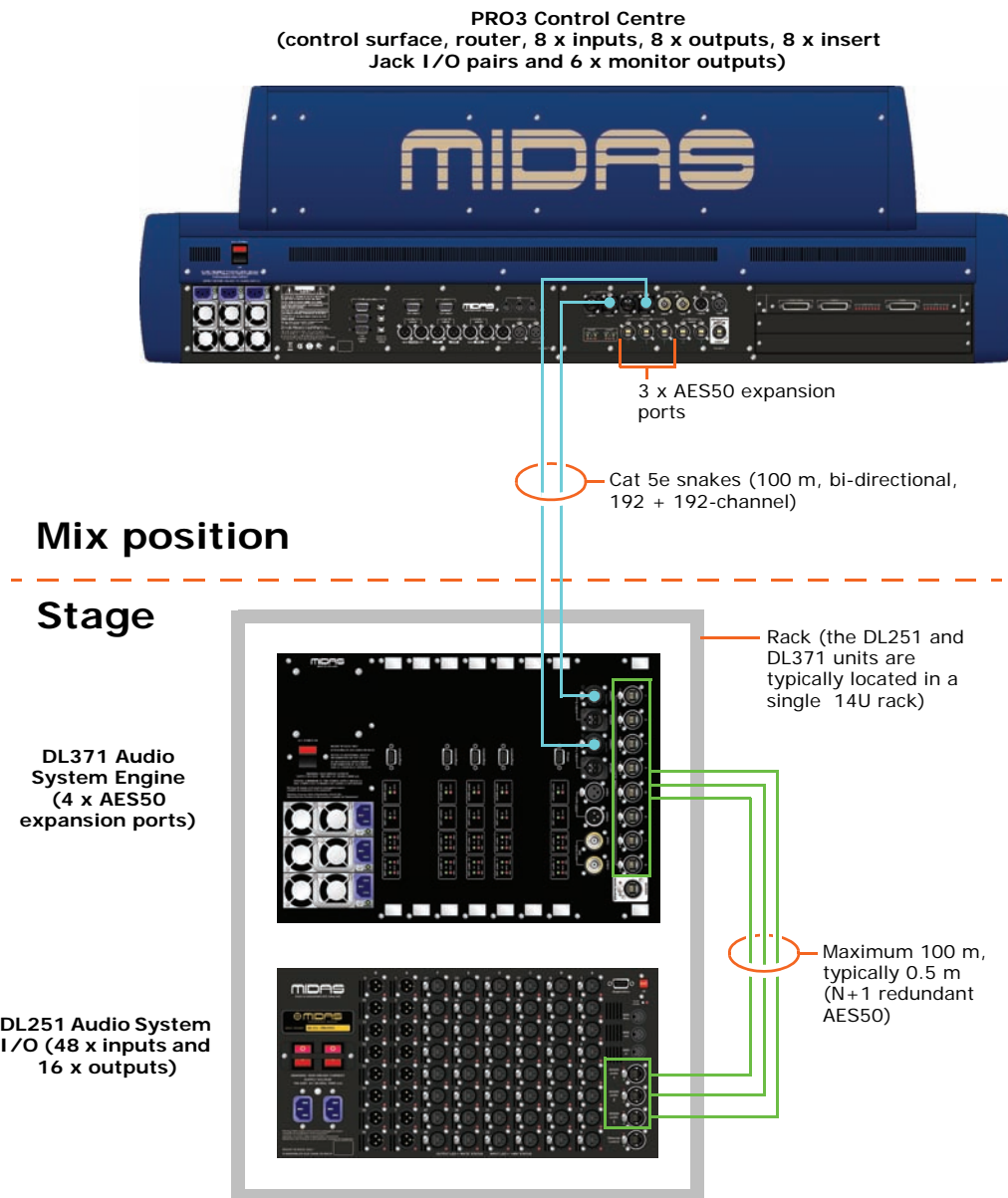

Figure 7: Standard PRO3 system configuration

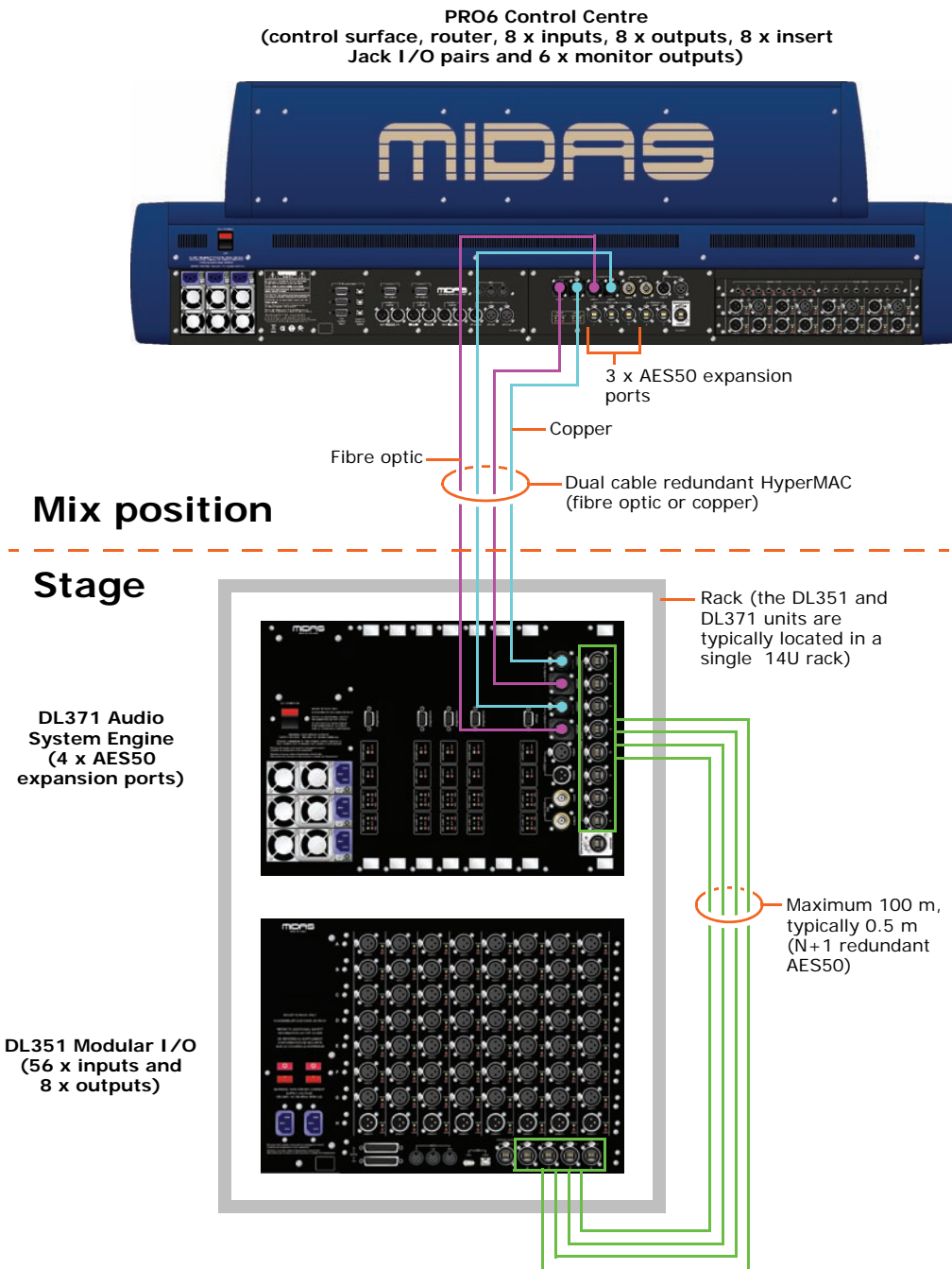

Figure 8: Standard PRO6 system configuration

PRO9 Control Centre
 (control surface, router, 8 x inputs, 8 x outputs, 8 x insert
 Jack I/O pairs and 6 x monitor outputs)



3 x AES50 expansion ports
 Copper
 Fibre optic
 Dual cable redundant HyperMAC (fibre optic or copper)

Mix position

Stage

DL371 Audio System Engine (4 x AES50 expansion ports)

DL351 Modular I/O (56 x inputs and 8 x outputs)

DL451 Modular I/O (24 x inputs)

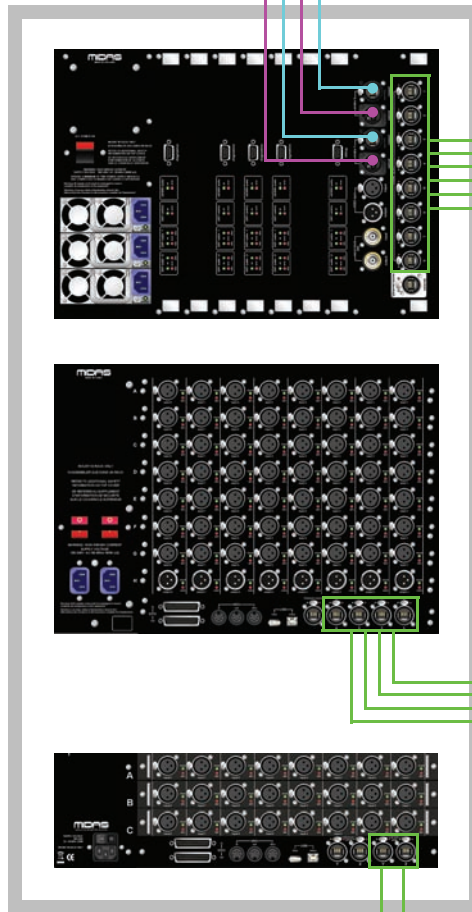

Rack (the DL351, DL371 and DL451 units are typically located in a single 14U rack)

Maximum 100 m, typically 0.5 m (N+1 redundant AES50)

Standard PRO9 system configuration

Powering the system

The following details the recommended power up and power down procedures for the system.

Note: *If you are in any doubt as to how to switch the rack units on/off, refer to their operator manuals.*

>> To power up the system

Important Note:

DO NOT switch on the speaker sub-system until after the start-up of the system has been completed.

After all system interconnections have been made (see “Wiring instructions” on page 38), start up the system by doing the following:

- 1 Make sure that all of the system equipment is switched off, such as the control centre, speaker sub-system, DL371 Audio System Engine unit and I/O unit(s).
- 2 Switch on the control centre (see “To switch on the control centre” on page 43).
- 3 In the master bay of the control centre, move all of the monitor and master channel faders to the minimum position and mute all of the master channels (see section F in Figure 5 “Main areas of the control surface” on page 29).
- 4 Power up the other system equipment, such as the DL371 Audio System Engine unit and I/O unit(s). This can be done in any order you like.
- 5 After the **status** indicator at the top of each GUI screen has changed to green (shown right), switch on the speaker sub-system.
- 6 Switch on the audio source and start playing the audio.
- 7 On the control centre, check that the audio inputs are routed to the master channels. Then, unmute the master channels and gradually increase their faders while listening to the sound levels from the speakers.



If there is no sound at all coming from the speakers when the faders are at maximum, move the faders to below the 0dB level and check if the audio is muted somewhere along the input paths and also check that the individual speakers are switched on. If there is still no sound from the speakers, see “No audio” on page 393.

>> To power down the system

Important Note:

BEFORE switching off any of the system components, don't forget to mute the audio from the speakers and switch off the speaker sub-system.

- 1 Mute the audio from the speakers and switch off the speaker sub-system.
- 2 Switch off the I/O unit(s).
- 3 Switch off the DL371 Audio System Engine unit.
- 4 Switch off the control centre (see “To switch off the control centre” on page 43).

Switching the control centre on/off

Carry out the following to switch the control centre on or off in a safe manner, observing all **WARNINGS** and **Cautions**.

>> To switch on the control centre



Caution (1)!

A minimum of two power supply modules must be supplying power to the control centre for correct operation.



Caution (2)!

Before switching on, check that all monitor loudspeaker power amplifiers are turned off or muted.

After connecting up the audio cables, carry out the following:

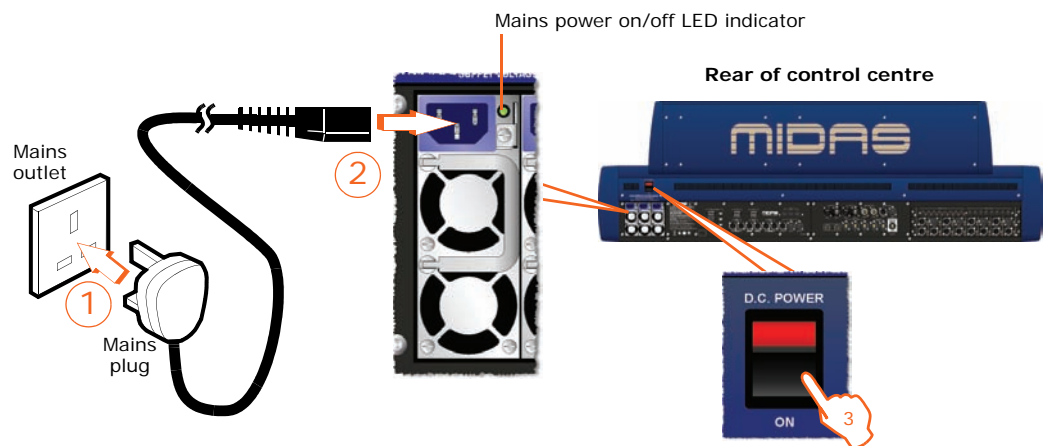

Switching on the control centre

- 1 Plug the three mains cables into the mains power outlets.
- 2 Observing **Caution (1)!** above, plug the Volex connectors (see "Wiring instructions" on page 38) of the mains cables into the mains sockets on the rear of the control centre. (The green LED next to each mains socket will illuminate if its mains supply is on.)
- 3 Observing **Caution (2)!** above, apply power to the control centre by switching the **D.C. POWER** switch on. The control centre will boot up and, when the default GUI screens are displayed, it is ready for use.

>> To switch off the control centre

- 1 Make sure you have saved any shows, scenes or settings you require (see "Saving your show files to a USB memory stick" on page 123).
- 2 At the GUI, choose **home** ▶ **Preferences** ▶ **Shutdown System**.
- 3 At the **Shutdown ENTIRE system?** prompt, click **OK**.
- 4 After the shutdown sequence has finished, switch off the **D.C. POWER** switch (rear of control centre).
- 5 Disconnect the mains cables from the rear of the control centre.



Setting up the ID of the unit(s)

After connecting up your system, you may need to set up the ID of the unit(s) in the rack, such as the DL351 Modular I/O, DL451 Modular I/O or DL431 Mic Splitter, as each unit must have its own unique ID number. (This does not apply to the DL251 Audio System I/O.)

Note: *The I/O unit doesn't have to be connected in the system for you to set up its ID, as the procedure can be carried out offline.*

>> To set up the ID of an unit

Although the programming menu of each type of I/O unit may look slightly different, the procedure for setting up its ID is basically very similar. For full instructions on how to set up the ID of each particular I/O unit, refer to its operator manual.

- 1 If necessary, switch on the I/O unit.
- 2 Press **MENU** and hold for approximately two seconds to enter the main menu.
- 3 If necessary, use the down arrow button  to navigate to the set ID option.
- 4 Press **SELECT** to enter the set ID option.
- 5 If necessary, use the down arrow button  to navigate to the desired ID number.
- 6 Press **SELECT** to select the ID number.
- 7 Press **MENU** repeatedly to exit the main menu. (The unit will automatically exit programming mode after 20 seconds of inactivity, that is, if none of the programming buttons are pressed within that time.)

Basic Operation Of The PRO Series

Chapter 5: Before You Start

This chapter is intended to familiarise you with the control centre by showing you how to carry out some basic operations in order to get some audio out of it.

Note: *As the operation of both input bays is principally the same, this chapter will generally only show the operation of the 12-channel input bay. However, any differences in operation between the 4-channel and 12-channel input bays will be shown.*

Please don't forget that, although this system is a complex, high-tech piece of equipment, it is very easy to use.

Principles of operation

Control centre operation is based on the concept of colours and groups rather than 'layering' or 'paging', which is the case with most digital consoles on the market today. With so many channels available it is far easier to remember them by their user-configured individual/group colour and name rather than their channel number.

The control surface is populated with instantly recognisable controls that are logically distributed in major sections, so that all the controls you need to access most of the time are always on the control surface, while the remainder are only one action away. You can display all I/O meters, both on the control surface and the GUI, to give instant monitoring feedback.

Operating modes

You can change certain aspects of control centre operation by assigning different tasks to certain areas of the control surface. This section will explain the different ways in which the control surface can operate.

Normal mode

During normal operation the 12-channel input bay is operated from the mix bay controls and GUI screen, while the controls and GUI screen in the master bay operate the 4-channel input bay. Both input bays operate in unison and are, in effect, area A.

Note: *The 12-channel input bay will always be area A, no matter which operating mode you are using.*

Using the 4-channel input bay as area B

You can assign the 4-channel input bay as area B, thus making both the input bays independent from each other. This facilitates two-man operation (see "Two-man operation" on page 122).

Operating the top output fast strips from the master bay

During normal operation, both rows of output fast strips — which are always independent from each other — are operated using the controls in the mix bay. However, you can assign the master bay to control the top row of output strips.

>> To switch control of the output strips to the master bay

Press the right arrow (**to right channel**) button (see Figure 12 “Output channel navigational controls” on page 66).

Controlling the mix buses in flip mode

Flip provides a more global approach to mix bus level control. Normally, you can only use the level control knobs in the channel strips to adjust the signal level of the aux/matrix mix buses going to the aux/matrix channels. However, by using flip you have the option of controlling them from either the **pan** control knobs or the faders in the input fast strips.

In flip mode the left/right arrow buttons in the upper **channel select** section scroll across the input fast strips.

>> To configure the control centre for pan or fader flip

- 1 At the GUI, choose **home ▶ Preferences ▶ General**.
- 2 Depending on which option you require, click the option button of one of the following in the **Fader flip** section. When an option is selected, it will contain a red circle:
 - “Flip to faders”.
 - “Flip to Pans”.

>> To flip mixes to input pan/fader control

With an output selected on the control surface, press **FLIP** (see Figure 11 “Mix bus navigational controls” on page 64). The button will illuminate to show you are in ‘flip’ mode. The currently selected mix bus in the input fast strips will change to AuxS1 and, on the GUI, the background colour of the pans and faders will change accordingly. Also, the LCD select buttons in the input fast strips will display the current bus mode, for example, “MONO AUX”.

Hints and tips

- **Check what is hidden** On the control centre, unlike on an analogue control surface, some of the settings and parameters will be hidden from view (stored in the computer memory of the control centre). At various times during a mix we recommend that you select and view unused parameters to make sure there are no hidden surprises, for example, a reverb send left from a previous mix.
- **Check the Meters screen** It is a good idea to frequently monitor the **Meters** screen (default display of the master bay GUI), which provides at a glance an overview of the control centre’s status and operation. It shows all the meters and the status condition of faders and some switches, such as solos and mutes. However, some things will still remain hidden.

Saving your work

We recommend that you save your work regularly while carrying out the procedures included in this chapter. Not only is this good practise during normal operation, but in this instance it may save you from losing some set-ups that could prove useful later on. To do this, create a new show (see “To open the Automation screen” on page 112), and then continue reading through the remainder of this section, following the instructions carefully. Save your work at convenient points (see “To create a new scene using the current settings” on page 115 and “To save a show or create a new one from the current settings” on page 113).

Saving a show versus storing a scene

It is important to understand the differences between saving a show and storing a scene.

- **Storing a scene** saves the current settings of the system to the show file. Scene data is *never* updated unless you manually store a scene. The show file remains unsaved in RAM.

Although the state of the control centre is copied every five seconds, it is not stored in a scene. Instead, it is placed in the NVRAM (non-volatile random access memory) of the control centre's memory, which is a type of RAM that doesn't lose its data when the power goes off. If the control centre loses power accidentally, these settings are loaded so that audio parameters are identical, thus avoiding audio level jumps. **When power is lost, the showfile loaded (if any) will not subsequently be restored, and any unsaved changes to it will be lost.**

- **Saving a show** copies the show file onto the internal solid-state disk of the control centre. This provides you with a ‘permanent’ copy, provided you shut down the system properly as detailed in the following section.

Shutting down the control centre properly

When switching off the control centre, we recommend that you use the shutdown option of the GUI menu (see “To switch off the control centre” on page 43).

By using shutdown, the cached copy of the show data, which is maintained by the system, is automatically stored. Shutdown then uses the current showfile, NVRAM data and cache files to restore the control centre to *exactly* the same state as at power down; even to the point of loading the unsaved show and placing you at the correct scene, with non-stored scene data at the control surface.

If you don't use the **Shutdown** option the audio parameters are still restored, but the show and show status (saved/unsaved) cannot be restored automatically. You must manually reload the show, and any unsaved changes will be lost.

Chapter 6: Working With The Control Centre





This chapter is intended to familiarise you with control surface and GUI controls of the control centre.



Although nearly all of the operations done via the control surface of the PRO Series Control Centre can be replicated via the GUI, the emphasis in this chapter — and throughout the manual — is on the former method. This is because, generally, control surface operation is quicker and more intuitive than using the GUI. However, GUI methods will be included where they are anomalous or if there is no control surface equivalent.

The navigational controls, such as quick access buttons and scroll buttons, are described in Chapter 7 "Navigation" on page 59, and the ones specifically for automation can be found in "Managing the scenes" on page 114.

About the PRO Series controls

Although the control centre is populated with many familiar analogue-type controls there are some that may be new to you, particularly the ones relating to navigation, grouping and the GUI. The following table shows some of the controls that can be found on the control surface of the PRO Series.

<i>Type</i>	<i>Description</i>	<i>Example(s)</i>
Pushbutton	Generally two-state, that is, on/off or enabled/disabled, and backlit or with an integral LCD for status indication. In all cases, an illuminated pushbutton on the control surface (or GUI) is on/enabled and an extinguished one is off/disabled, unless otherwise stated.	 
Control knob	In general, the control knobs (rotary controls) are touch-sensitive, their adjustment being shown on the GUI. Some control knobs are backlit to help identify their role and what they control.	
Fader	The high quality motorised faders are, similarly to the control knobs, touch-sensitive so that their operation can be tracked and simulated on the GUI.	

Type	Description	Example(s)
LED	Show status indication. An illuminated LED shows an active (on) or enabled condition and, when extinguished, it indicates an off or disabled condition.	
Meter	All of the input fast strips, master fast strips and monitors have a peak level meter. There are also ones for the centre speaker and subwoofer of the 5.1 surround panning. In addition, each input fast strip has a gain reduction meter for both the compressor and gate. Meters are included on a number of the GUI screens. The 'all meters' display of the master bay's default GUI screen (see Figure 20, "Layout of the GUI screens," on page 116) provides an overview of what is happening in the PRO Series by displaying meters for all of the channels (inputs, outputs, monitors etc.).	

About channel operation

During normal operation the task of controlling the input (12 channels), aux, return and matrix channels is allocated to the two bays on the left. The two bays on the right control the input (4-channel) and master channels.

This task allocation applies similarly to the GUI screens. However, you can control any channel from either GUI screen. This is done by navigating the channel to the GUI channel strip via the GUI menu; control is also then available via the local channel strip on the control surface.

About GUI operation

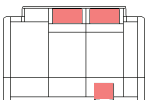

This section explains the basic procedures you can perform at the GUI screens. In general, you will control and operate the GUI by combining the operations described here.

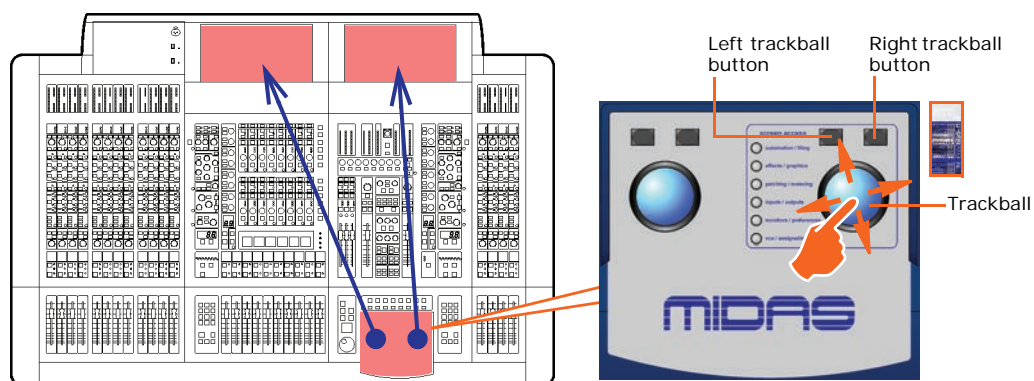

Figure 9: Controlling the GUI

The GUI is not just an additional feature that enhances control surface operation, it is a fully-featured tool in its own right. Not only does it show what is happening on the control surface, but all of its controls are functional. The GUI contains most of the controls found on the control surface and, in addition, has features that allow configuration of the PRO Series and provide extra functionality.

The GUI is operated via the primary navigation zone and is principally the same as using a laptop PC, although you can operate either screen using an external USB mouse instead (see “Using an external USB mouse” on page 244). A USB keyboard is plugged into the PRO Series for text editing.

Each trackball controls the movement of a pointer on its respective GUI screen (see Figure 9). The left trackball operates the mix bay GUI screen and the right one operates the GUI screen in the master bay. Each trackball has two buttons, which have similar functionality to the buttons on a PC/laptop mouse. The left button is used in click and drag operations, while the right button is generally used for editing and finer control operations.

Click

Moving the pointer to a specific point of the GUI screen and pressing the left button is called “clicking”. This is fundamental to GUI operation and forms the basis of many of its operations, such as switching a button on/off, selecting list and menu items, text editing etc. Doing the same with the right button is called “right-clicking”.

Drag

Moving the pointer to a specific point of the GUI screen and then pressing the left button while moving the pointer up/down/left/right is called “dragging”. Dragging is used mainly to adjust control knobs and faders, and to move sliders (attached to drop-down lists)—although it is also used to select blocks of connectors when patching (see “To select a block of patch connectors in the From section” on page 95). The pointer disappears when the control has been selected to show that it is ready for adjustment.

Common GUI screen elements

In general, you will see a banner at the top of both GUI screens that contains a number of elements as follows:



<i>Item</i>	<i>Description</i>
1	home button, opens the GUI main menu (see “GUI menu options” on page 336).
2	Screen navigation buttons (see “To find a GUI screen that you recently opened” on page 68).
3	Name of current screen.
4	“Not Saved” message appears when the currently selected scene/preset library file has changes that have not been saved.
5	Title of currently selected scene.
6	status LED, indicates the health and status of the system (see “Diagnostics” on page 393).
7	Copy and paste buttons (see “Using copy and paste” on page 118).
8	User library buttons (see “User library (presets)” on page 119).

Parameter values displayed on touch

You can configure the PRO Series (see “Changing the user interface preferences” on page 250) so that the GUI displays the current value (and dimension) of the control being adjusted.



Operating the GUI screen controls

This section shows you how to operate GUI screen elements, such as buttons, control knobs, drop-down lists and sliders.

>> To switch a GUI button on/off

Click the button. If it has a status indicator, this will illuminate/extinguish to show that it is on/off, respectively.

>> To adjust a GUI control knob or fader

Use a drag operation. Move the pointer up/down/left/right for adjustment.

Using drop-down lists

Certain configurable name fields, particularly the signal routing ones, have drop-down lists that offer a number of preset or context-sensitive options to choose from. Long lists — containing more options than can be displayed simultaneously — have sliders that allow you to access all the options.

>> To select an option from a drop-down list

- 1 Click the drop-down arrow. The drop-down list will unfold to display some or all of its contents, depending on how many items it contains.
- 2 Do one of the following:
 - Click the option you require.
 - If necessary, scroll the list (see “To scroll a drop-down list” below) to display the option, and then click it.

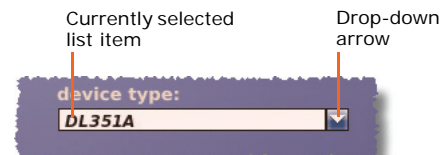

>> To scroll a drop-down list

With the drop-down list displayed, do one of the following:

- Drag the scroll box.
- Click the scroll bar. The scroll box will ‘jump’ in the direction of the click to another position in the scroll bar.
- Click an up/down scroll arrow. The scroll box will ‘jump’ in the direction of the scroll arrow to another scroll bar position. Clicking a scroll arrow when the scroll box is adjacent to it has no effect.

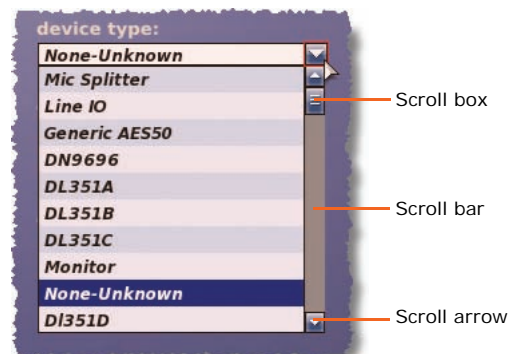

Spin buttons

Up/down spin buttons let you increase/decrease the attribute or value of an item. For example, the amount of time a signal is delayed (see “Input channel delay (GUI only)” on page 284).



About windows

There are three main types of window you will encounter when using the GUI, as follows (an example of each is shown in the diagram on the right):

- **Properties** windows contain elements that you can select or edit, such as options, lists, tick boxes, text fields etc.
- **Message** windows contain text that can be a prompt or an error message. Generally, this type of window will contain an **OK** and a **CANCEL** button by which you can acknowledge the message or cancel the operation, respectively. Also, some message windows contain a user-editable text field, as shown in the example (right).

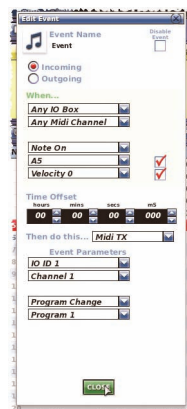

Properties window



Message window

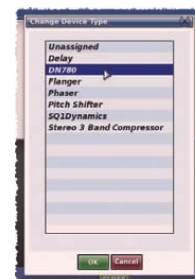

List window

- **List** windows have a number of user-selectable options in the form of a list, and some may also include an **OK** and a **CANCEL** button.

Similar to a window found on a PC running a Windows-based operating system, windows can be moved around the screen, which is useful if you need to see what is behind the window. Also, each window has a close (X) button at its upper-right corner.

>> To close a window

Do one of the following:

- If the window has an **OK** button, and you have made the requisite changes in the window or you wish to acknowledge its message, click **OK**.
- If the window has a **CLOSE** button, click **CLOSE**. Changes made in this type of window update the control centre 'live', that is, as soon as you make them, so clicking **CLOSE** merely closes the window.
- If the window has a **CANCEL** button, and you wish to cancel any changes or abort the operation, click **CANCEL**.
- Click "(X)" at the upper-right corner of the window.

>> To move a window

Use drag, first clicking on the window's blue bar (top) and then dragging the window where you want it.

Using the GUI menu

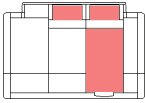

You can open the GUI menu at either GUI screen or you can go directly a GUI menu screen by using a **screen access** button.

Throughout this manual, menu/submenu option selection sequences are shown in the following format (for example, for choosing the general preferences screen):

home ▶ Preferences ▶ General

>> To open the GUI menu

Click **home**.

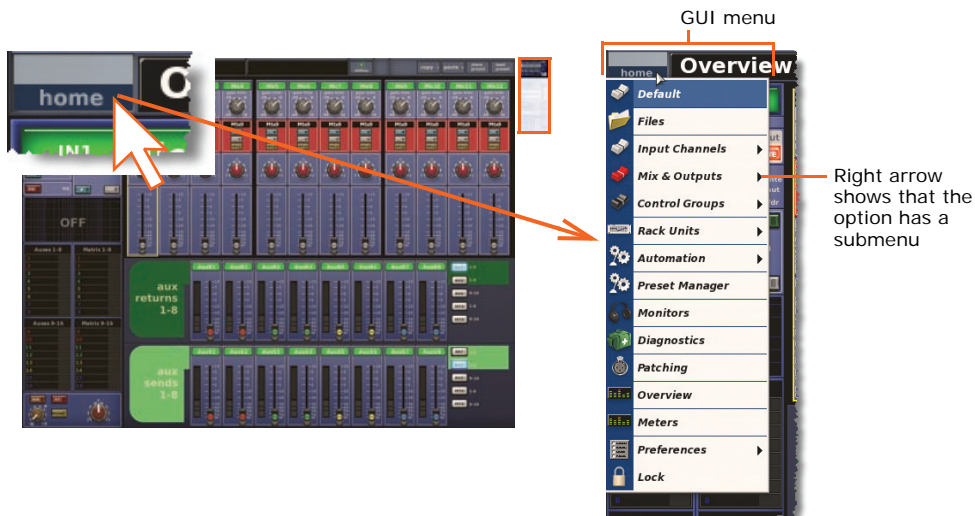

Opening the GUI menu

>> To select a GUI menu option

Click the menu option, for example, **Monitors**. The background of the menu option will change to blue when it is ready for selection.

>> To open the submenu of a GUI menu option

Move the pointer over the arrow to the right of the desired menu option. The submenu will open automatically to the right of the arrow.

>> To open a GUI menu screen using a screen access button

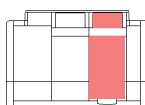

In the primary navigation zone, press a **screen access** button to open the first screen (printed to the right of the button). Press it again to open the second screen.

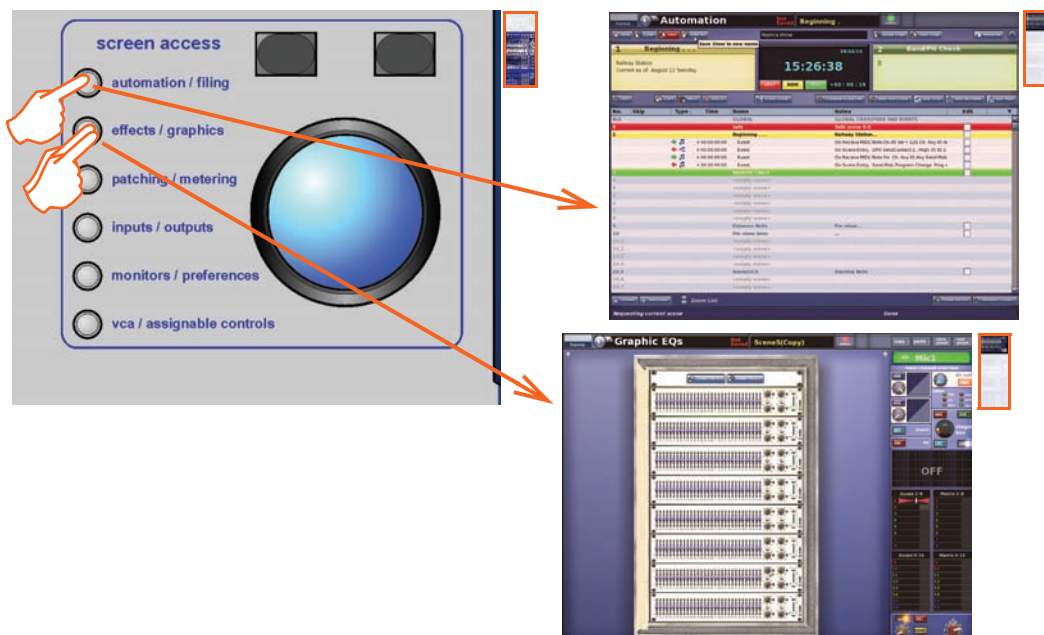

These two examples show you how to use the **screen access** buttons to open the **Automation** screen (single press) and the **Graphic EQs** screen (two presses). These buttons take you directly to the screen you want.

Text editing

A keyboard is used to type in text on the GUI, for example, to configure input and output channel names. Editable text on the GUI is contained in text boxes, which generally consist of a single line of limited length. Although all text editing can be done using the normal keyboard functions, the GUI can be used to assist you, for example, by highlighting portions of text (using drag).

>> To enter/edit text via the keyboard

- 1 At the GUI, click in the text box to place an insertion point in it. The pointer will change to an I-beam shape.
- 2 Using the keyboard, type in the new text. If the text box already contains some text, you can delete this first or edit it, which can be done via the keyboard or by using the cut, copy and paste options after right-clicking.
- 3 Press ENTER on the keyboard to exit the text box (or click on an empty area of the GUI screen). The pointer's shape will change back to an arrow.

Chapter 7: Navigation

This chapter introduces you to navigation on the control centre and shows you how to use its navigational tools.

For information on navigating the scenes in automation, refer to “Managing the scenes” on page 114.

An introduction to navigation

The control centre provides you with unique navigational controls to quickly and easily access the items, such as channels, buses, groups and processing areas, that you will require for mixing.

Navigation is an important feature of the control centre. One of the advantages digital consoles have over analogue ones is that their channel count is not limited by the control surface hardware. However, this means that only a certain amount of channels can be at the control surface at any time, while the others are ‘hidden’. So, navigation is required to access these hidden channels whenever you need them.

Note: The way the control centre is set to operate may alter the function of some of the navigational controls. For more information, see “Operating modes” on page 47.

Navigation is primarily via the control surface, although the GUI may provide an alternative and also has some unique navigational features of its own.

Navigating the input channels

The input channels are grouped into ‘banks’, with each bank containing four consecutively numbered channels.

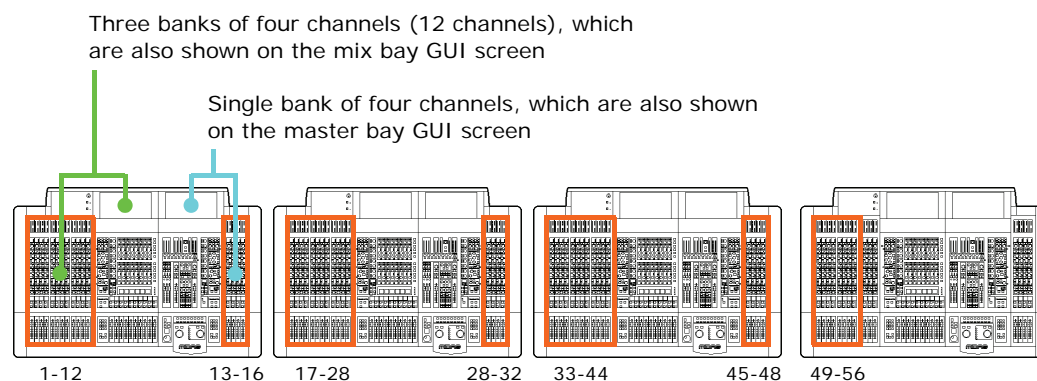

Shows the number of control centres you would need to display all of the inputs of the PRO6 simultaneously and helps to illustrate how the inputs populate the control surface (and GUI) in banks of four

During normal operation, four banks of input channels populate the input bays, and these are displayed across the control surface in ascending order from left to right.

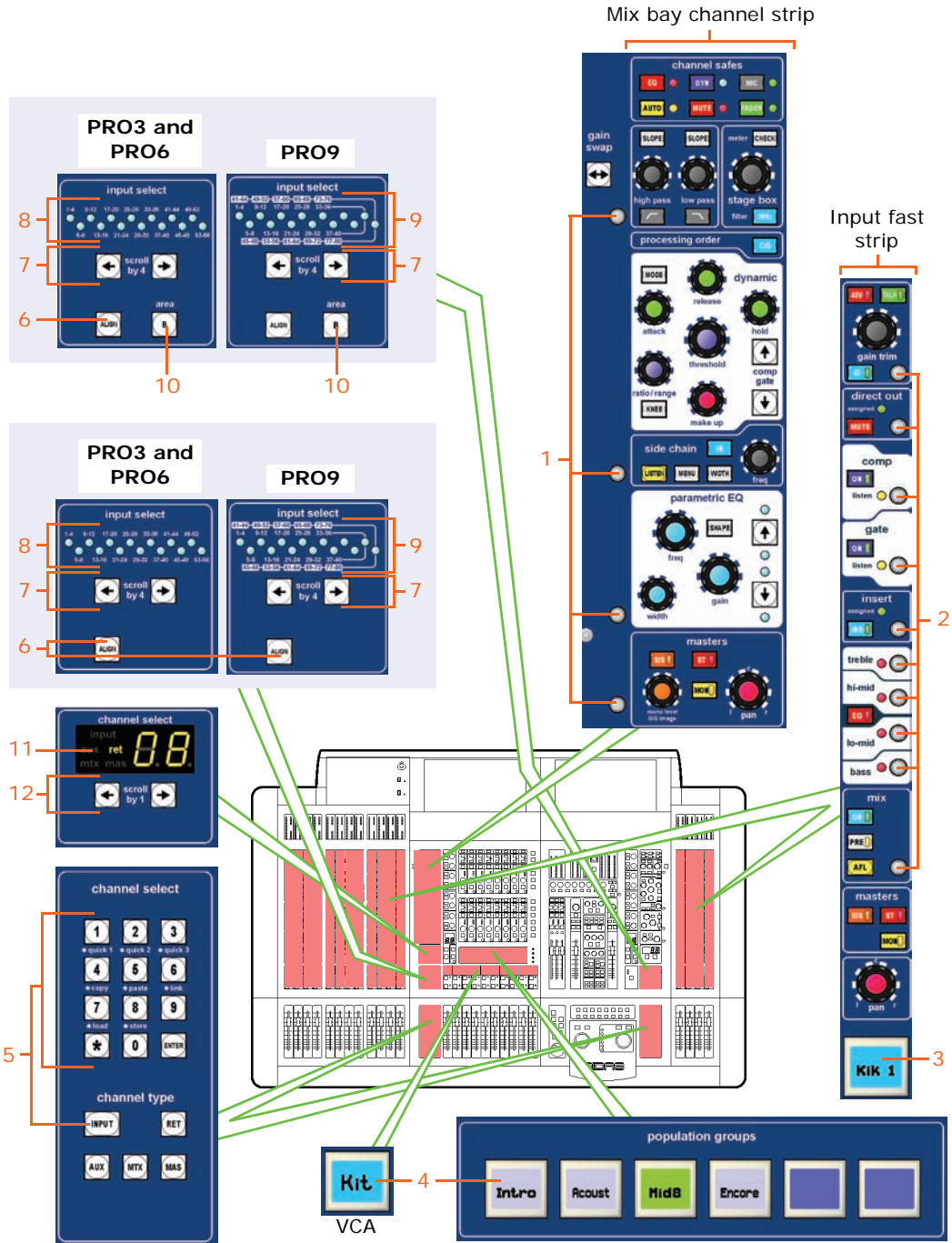
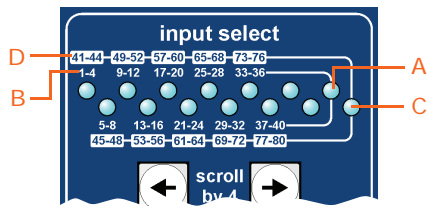

Figure 10: Input channel navigational controls

Item	Element(s)	Description
1	Quick access button — channel strip	Quickly selects the local processing area of the selected channel or channel pair, but doesn't affect channel selection. Illuminates (blue) when active.
2	Quick access button — input fast strip	Quickly selects the local input channel and assigns the local processing area to the mix bay channel strip. Illuminates (blue) when active.

<i>Item</i>	<i>Element(s)</i>	<i>Description</i>
3	LCD select button — input fast strip	Selects the local input channel. Has a backlit LCD display (with user-configurable backlight colour), which shows channel name etc. When selected, the display changes to a 'negative' image.
4	LCD select button — VCA/POP group	Selects the VCA/POP group, unfolding the group members to the control surface. Has a backlit LCD display (with user-configurable backlight colour), which shows group name. This button is also used for setting up the group (see "To assign channels to a VCA/POP group" on page 104).
5	Channel select keys and button	The INPUT button in the channel type section is used with the number keys in the lower channel select section to select a specific channel number, assigning it to the control surface (see "Fault finding a problem channel" on page 69).
6	ALIGN button	Navigates the currently selected input channel to the local input bay (see "To navigate the selected input channel back to the control surface" on page 62).
7	scroll by 4 buttons	These left and right scroll buttons scroll through the input channels four channels (one bank) at a time.
8	LEDs	PRO3 and PRO6: These LEDs illuminate to show you which inputs currently populate the control surface. Each LED represents a bank of four input channels. When using VCA/POP groups, an LED will flash if its bank contains a channel(s) that are members of the selected group, but don't currently populate the control surface.
9	LEDs	PRO9: These LEDs illuminate to show you which inputs currently populate the control surface (see diagram below). When using VCA/POP groups, either of the two LEDs on the right will flash if any of their banks contain a channel(s) that are members of the selected group, but don't currently populate the control surface.
10	B button	Assigns the 4-channel input bay as area B, which then operates with the master bay channel strip.
11	Display	Shows the number of the currently selected channel and its type.
12	scroll by 1 buttons	These left and right scroll buttons scroll through the channels one at a time. Channel selection follows the scrolling.



To cater for the higher channel count of the PRO9 the LEDs to the right of the **input select** section (A and C) illuminate to show whether the numbered LEDs to the left are referring to the lower (B) or higher (D) numbered banks of inputs, respectively.

>> To assign an input channel to the control surface

Do one of the following:

- **Scroll buttons** Scroll the desired input channel to the control surface using the **scroll by 4** buttons in the **input select** section.
- **VCA/POP group buttons** If the desired input channel is in a group, press its VCA/POP group LCD select button.

You can use the GUI menu to select any VCA/POP group you want via the **home ▶ Control Groups ▶ VCA Groups** option.

>> To select an input channel

With the desired input channel currently assigned to the input fast strips on the control surface, do one of the following:

- **LCD select button** Press the LCD select button in the desired input fast strip. This will assign the input channel to the local channel strip and its **input channel overview** to the GUI channel strip.
- **Quick access button** Press any quick access button in the desired input fast strip. This will assign the input channel to the local channel strip and its local processing area to the GUI channel strip.
- **Touch sensitive control knobs** Touch/operate one of the control knobs in the desired input fast strip. This will select the input channel.

You can use the **scroll by 1** buttons in the upper **channel select** section to scroll channel by channel to go to the input channel you want. You can scroll all of the input channels using this method and the desired input channel doesn't have to be assigned to the control surface initially. Channel selection follows the scrolling.

You can use the GUI menu to select any input channel you want via the **home ▶ Input Channels** option.

>> To navigate the selected input channel back to the control surface

If you have navigated the currently selected input channel away from the control surface, you can bring it back by pressing **ALIGN**.

>> To select a processing area

You may want a specific processing area of an input channel assigned to the local channel strip, for example, to carry out processing or for copying its parameters to another input channel.

Do one of the following:

- **Quick access button (channel strip)** If the input channel you want is currently selected at the control surface, press the quick access button local to the desired processing area in the channel strip.
- **Quick access button (input fast strip)** If the input channel you want is currently at the control surface, but is unselected, press the quick access button local to the desired processing area in its input fast strip.

You can select a processing area via the **input channel overview** in the GUI channel strip by clicking within a non-control area of the desired section.

Navigating the mix buses

The input channels each have aux and matrix mix buses.

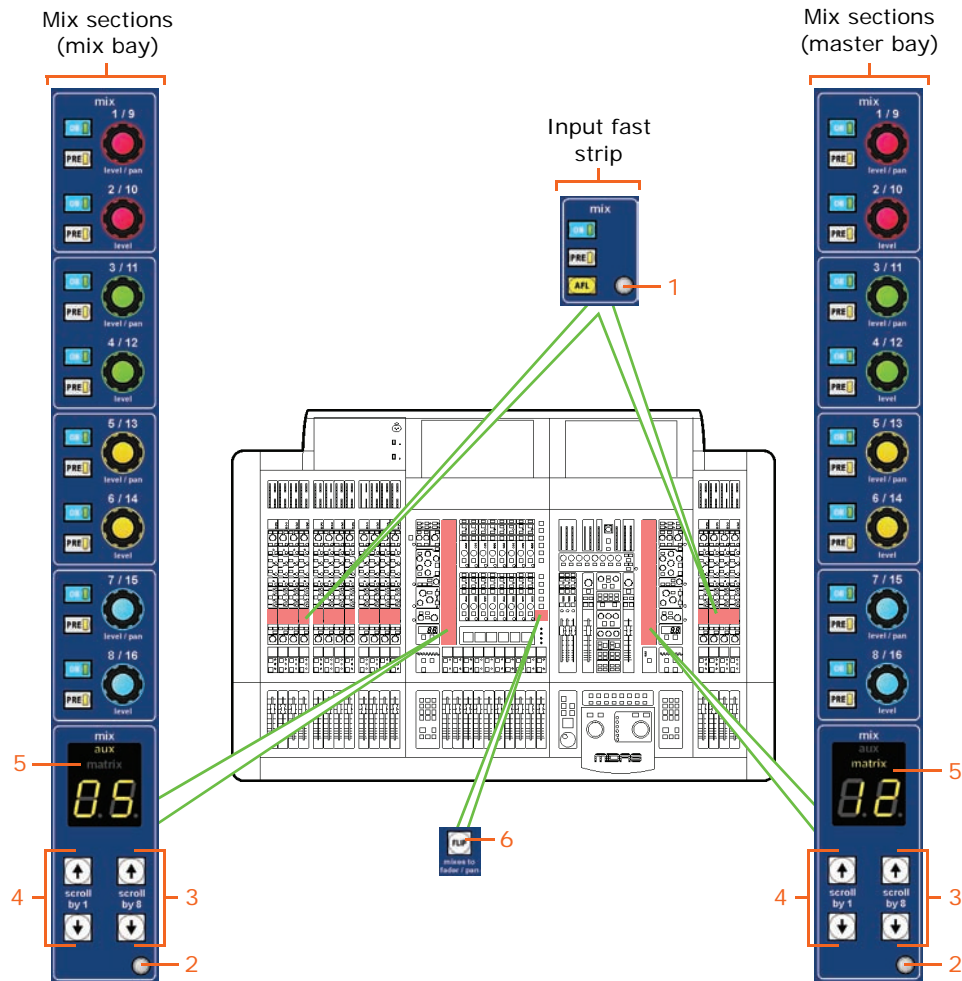

Figure 11: Mix bus navigational controls

Item	Element(s)	Description
1	Quick access button — input fast strip	This button in the mix section of the input fast strips quickly selects the local mix area of the selected channel. Illuminates (blue) when active.
2	Quick access button — mix section	This button in the mix section of the mix and master bays quickly selects the bank of the currently selected aux/matrix bus, assigning it to the local channel strip on the control surface, and also assigning the bus processing area to the local GUI channel strip. Illuminates (blue) when active.
3	scroll by 8 buttons	These up and down scroll buttons scroll through the mix buses in groups of eight (one bank) at a time.
4	scroll by 1 buttons	These up and down scroll buttons scroll through the mix buses one at a time. Mix bus selection follows the scrolling.

<i>Item</i>	<i>Element(s)</i>	<i>Description</i>
5	Display	Shows the number of the currently selected mix bus and its type.
6	FLIP button	See "Controlling the mix buses in flip mode" on page 48.

>> To navigate a mix bus to the control surface

Do one of the following:

- Scroll to the desired mix bus using the **scroll by 1** buttons in the **mix** section. Mix bus selection follows the scrolling.
- Scroll the desired bank of mix buses to the control surface using the **scroll by 8** buttons in the **mix** section.

>> To select a mix bus

Do one of the following:

- **Scroll buttons** Scroll to the desired mix bus using the **scroll by 1** buttons in the **mix** section. Mix bus selection follows the scrolling.
- **Touch sensitive control knobs** With the desired mix bus assigned to the **mix** section on the control surface, touch/operate its control knob.

>> To navigate the mix bus processing area to the channel strip

Press the quick access button in the **mix** section of the desired input fast strip. This does not affect the current population of the output fast zone.

You can select an aux bus or matrix bus processing area on the GUI by clicking on the title of the desired bank of mix buses in the **input channel overview** of the GUI channel strip (see Figure 17, "Typical sends sections of the mixes in the GUI channel strip," on page 106).

Navigating the output channels

The output channels comprise auxes, returns, matrices and masters.

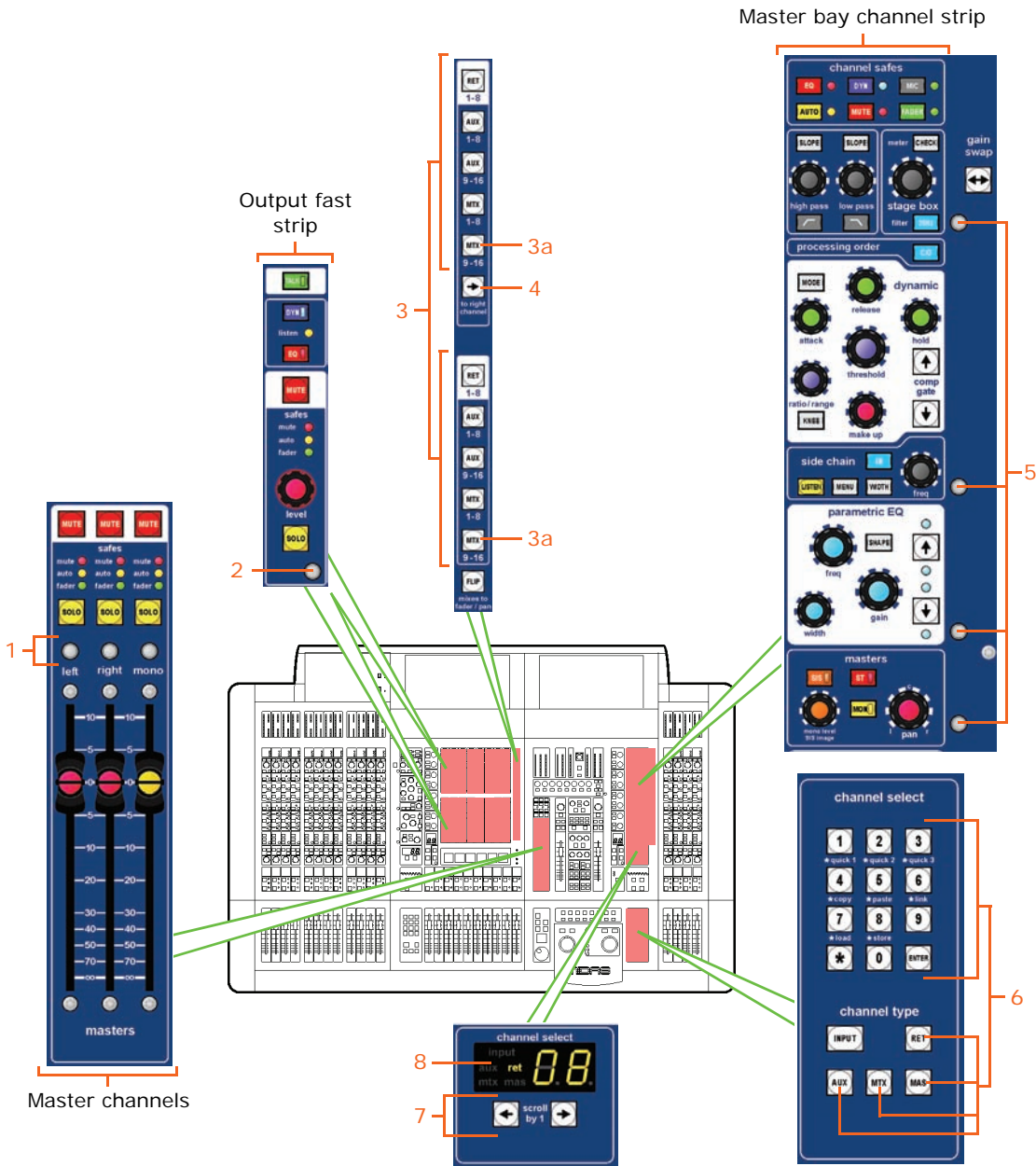

Figure 12: Output channel navigational controls

Item	Element(s)	Description
1	Quick access button — master channels	Quickly selects the local master channel. Illuminates (blue) when active.
2	Quick access button — output fast strip	Quickly selects the local output channel. Illuminates (blue) when active.

<i>Item</i>	<i>Element(s)</i>	<i>Description</i>
3	Channel select buttons	Each button assigns its bank of channels to the eight output fast strips to the left. PRO3 only: The MTX buttons (3a) for output channels 9 to 16 are not used.
4	Right arrow button	See “Operating the top output fast strips from the master bay” on page 48.
5	Quick access button — channel strip	Quickly selects the local processing area of the selected channel or channel pair, but doesn’t affect channel selection. Illuminates (blue) when active.
6	Channel selection keys and buttons	The buttons in the channel type section (except the INPUT button) are used with the number keys in the channel select (lower) section to select a specific output channel number, assigning it to the control surface (see “Fault finding a problem channel” on page 69).
7	scroll by 1 buttons	These left and right scroll buttons scroll through the channels one at a time. Channel selection follows the scrolling.
8	Display	Shows the number of the currently selected channel and its type.

>> **To assign output channels to the control surface**

Do one of the following:

- **Channel type buttons** Press the desired channel type button to assign its bank of eight outputs to the local row of output fast strips on the control surface. For example, press the upper **RET** button to assign returns 1 to 8 to the upper row of output fast strips.
- **Scroll buttons** Scroll the desired output channel to the control surface using the **scroll by 1** buttons in the **channel select** (upper) section.

You can assign a bank of channels to the output fast strip via the GUI. Similarly to the layout of the control surface, the overview GUI screen has channel select buttons to the right of the two rows of outputs (see Figure 6, “Typical Overview screen (default of the mix bay GUI screen),” on page 30). Click the desired channel type button to assign its bank of outputs to the row on the left. For example, click the lower **AUX** button to assign auxes 1 to 8 to the lower row of outputs.

>> **To select an output channel**

Do one of the following:

- **Quick access button (output fast strip)** To select an output channel that is currently assigned to the output fast strips, press its local quick access button in the desired output fast strip. This will assign the output channel to the local channel strip.
- **Quick access button (master channel)** To select a master channel, press its local quick access button. This will assign the master channel to the local channel strip.
- **Touch sensitive control knobs** Touch/operate the control knob in the desired output fast strip. This will select the local channel and assign it to the local channel strip.

You can use the GUI menu to select any output channel you want via the **home ▶ Mix & Outputs** option.

>> To select a processing area

You may want a specific processing area of an output channel assigned to the local channel strip, for example, to carry out processing or for copying its parameters to another output channel. To do this, provided the output channel is currently selected at the control surface, press the quick access button local to the desired channel strip's processing area to select it.

You can select a processing area via the GUI by clicking on a non-control area within the desired section of the 'overview' display (aux send, aux return, matrix or master) in the GUI channel strip.

Navigation via the GUI

The GUI has unique navigational tools by which to return to a channel 'overview' display from one of its processing areas in the GUI channel strip, and also to browse through the GUI screen display history.

>> To navigate back to a channel's overview display from one of its processing areas in the GUI channel strip

Click the up arrow.



>> To find a GUI screen that you recently opened

Use the back/forward browser buttons to do one of the following:

- To return to the GUI screen you have just opened, click the back button.
- To open one of the GUI screens you have recently visited, click the back/forward buttons. The back button will take you back through your browser history, while the forward button goes the opposite way.



The back/forward buttons are similar to those on standard browsers used on any PC.

Fault finding a problem channel

If you know the number of the channel that has a problem, you can quickly navigate it to the control surface by typing in its channel type and number via the lower **channel select** (lower) and **channel type** sections.

>> To select a channel using its number

- 1** In the **channel type** section, press the button of the desired type. For example, if the channel is an input, press **INPUT**.
- 2** In the **channel select** (lower) section, type in the channel's number. For example, press **4** and then **7** for channel 47.
- 3** Press **ENTER**.

Chapter 8: Patching

This chapter describes the patching feature of the PRO Series.

Introduction

Patching is a GUI-only feature that lets you carry out all system routing requirements. The GUI main menu has a **Patching** option that takes you to the **Patching** screen, which contains all of the available patching connectors in the system. This screen provides an easy-to-use interface, where you can select your source and destination patching options, facilitated by a panel of function buttons. Additionally, the **Patching** screen lets you set up the units (devices). For example, you can adjust the analogue gain, select +48V phantom voltage etc., of the line I/O units connected in the system.

Terms used in PRO Series patching

The following is an explanation of the patching terms:

- **Checkpoint** A patching data store point, created by clicking **CHECKPOINT**.
- **Destination** The patch connector to which a signal is routed.
- **Device** A diagram in the I/O tabs that represents a physical rack unit, such as a line I/O, mic splitter, DN9696 etc.
- **Drag** A method of selecting a block of source patch connectors in the **From** section of the Patching screen (see "To select a block of patch connectors in the From section" on page 95).
- **From section** The leftmost area of the patching screen that contains the source patch connectors.
- **Patch connector** Any tab patching point, for example, an XLR connector, bus, sidechain compressor etc.
- **Patching** The process of routing a channel/signal from a source to a destination(s).
- **Source** The patch connector from which a signal is patched.
- **Tab** A 'sheet' in the **From** and **To** sections that contains a specific group of patch connectors.
- **To section** The rightmost area of the Patching screen that contains the destination patch connectors.

About the Patching screen

The **Patching** screen has two main areas: a function button panel towards the top of the screen and a patching area below. The function buttons provide the required patching functionality and allow I/O tab devices to be set up. The patching area provides access to all the patch connectors.

The patching area is split equally into two independent sections, called **From** and **To**, which contain the source and destination patch connectors, respectively. The patch connectors are grouped on tabs according to type. Only one tab per section will be visible at any time.

The I/O tabs represent the Stage and FOH racks, and contain graphical representations (devices) of the units connected in those racks.

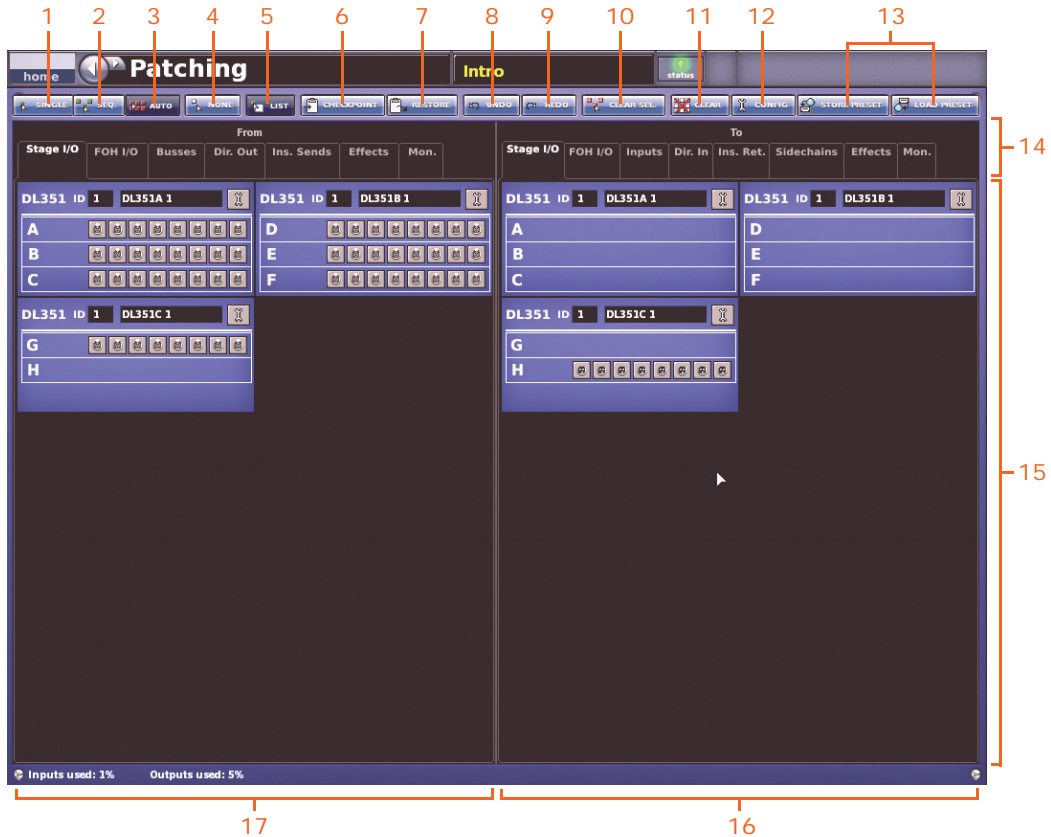

Figure 13: **Patching** screen

<i>Item</i>	<i>Element</i>	<i>Description</i>
1	SINGLE button	Lets you patch a single source to a single destination or multiple destinations. See "Single patching (SINGLE)" on page 96.
2	SEQ. button	Lets you select multiple sources and patch them one by one (see "Sequence patching (SEQ.)" on page 97).
3	AUTO button	Lets you select a block of sources and patch them all automatically, simply by selecting a single destination. Any existing patches within the destination range will be replaced by the new ones. See "Automatic patching (AUTO)" on page 97.
4	NONE button	Clears all currently selected patch connectors from all tabs in the From and To sections.
5	LIST button	Changes the tooltip type from standard to list when carrying out a sequence patching operating via the SEQ. button (see "List tooltip" on page 88).
6	CHECKPOINT button	Sets a patching store point, or snapshot, that contains the patching status at that instant. Each time CHECKPOINT is clicked the previous checkpoint is overwritten.

<i>Item</i>	<i>Element</i>	<i>Description</i>
7	RESTORE button	Reverts patching status to the last checkpoint or, if no checkpoints have been created, it will revert patching status to the power up condition. All patching done in the intervening period will be lost.
8	UNDO button	Undoes the latest single patch, even if it was part of a multiple patching operation. Repeated clicks will undo the preceding patching operations, going back to the last checkpoint, or power up if no checkpoints have been created.
9	REDO button	Redoes an undo. This can be repeated for each undo in the previous undo operation.
10	CLEAR SEL. button	Clears all current selections and their patches. Important: Unlike the NONE button, which merely removes the current selections (highlighted in yellow), CLEAR SEL. goes a step further by removing the patch as well. This will stop any audio that may have been going through the patched signal.
11	CLEAR button	Clears all patching (see "To clear all current patching" on page 98). Important: Exercise great caution when using this function. Observe the warning that appears after clicking this button.
12	CONFIG button	Opens the AES50 Device Configuration window, from where you can set up the I/O tabs in the Patching screen (see "Typical AES50 Device Configuration window" on page 92).
13	STORE PRESET and LOAD PRESET buttons	These are user library (preset) function buttons (see Chapter 24 "User Libraries (Presets)" on page 235).
14	Title section	Section titles and tab names.
15	Patching area	Contains all of the patch connectors on tabs.
16	To section	Houses the tabs that contain all of the patch connector destinations (see Table 4 "Patching screen tabs" on page 75).
17	From section	Houses the tabs that contain all of the patch connector sources (see Table 4 "Patching screen tabs" on page 75).















>> To access the Patching screen

Do one of the following:

- At the GUI, choose **home** ▶ **Patching**.
- Press the **patching/metering** button in the primary navigation zone.
- At the GUI, click a **src** (source) or **dest** (destination) button. The **Patching** screen will open at the appropriate tab/configuration window.

What the Patching screen symbols mean



The following table gives a description of all the symbols that appear on the Patching screen tabs.

<i>Symbol</i>	<i>Description</i>
	During patching, this triangle appears under a tab name when the tab contains a selected patch connector.
	Shown at the top of the channel patch connectors, this box aids channel identification by matching the user-configured colour for that channel.
	Insert return patch connector.
	Insert send patch connector.
	Bus or channel source patch connector.
	Bus or channel destination patch connector.
	Female XLR chassis patch connector (input).
	Male XLR chassis patch connector (output).
	Jack patch connector.
	Non-functional patch connector, that is, one that cannot be patched.
	Compressor sidechain input patch connector.
	Gate input patch connector.
	DN9696 recorder patch connector.
	Set-up button, which opens the device configuration window (see “Configuring the devices” on page 89 for details).

About the tabs in the From and To sections

Each tab in the **From** and **To** sections of the **Patching** screen contains graphical representations of the PRO Series source and destination patch connectors, respectively. For details of where you can access the tab sheets in the **From** and **To** sections from, see “Navigating to the Patching screen” on page 85.

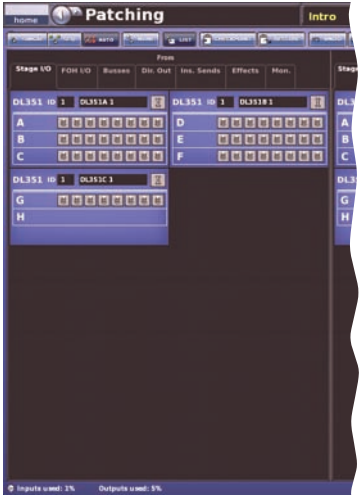
Table 4: Patching screen tabs

<i>Tab name</i>	<i>Section</i>	<i>Description</i>	<i>Example</i>
Stage I/O	From	The Stage I/O tab (see Figure 14, “Typical AES50 Device Configuration window,” on page 92) contains the devices fitted in the Stage rack (see “System components” on page 14). For information on what devices can be fitted in the I/O rack, see “About the devices on the stage and FOH I/O tabs” on page 85.	
FOH I/O	From	The FOH I/O tab contains the devices fitted in the FOH rack (see “System components” on page 14). For information on what devices can be fitted in the I/O rack, see “About the devices on the stage and FOH I/O tabs” on page 85.	

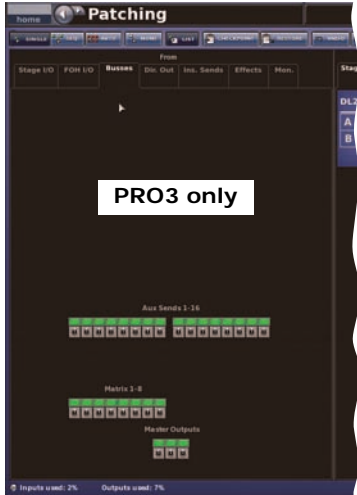
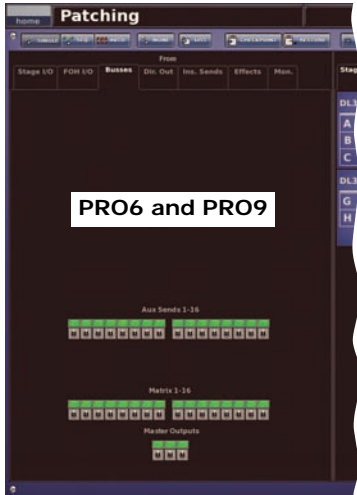
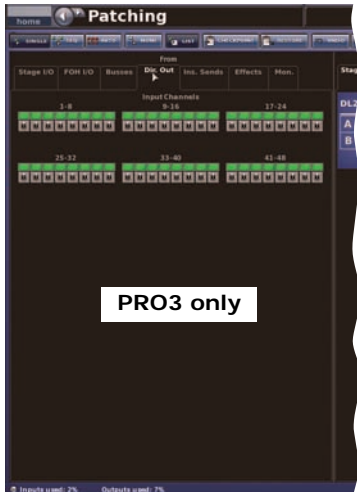
Tab name	Section	Description	Example
Busses	From	The Busses tab allows routing from the auxes, matrices and master outputs.	 
Dir. Out (Direct Out)	From	The Dir. Out (Direct Out) tab lets you patch any of the input channels internally (for example, to an effect) or provides a way out of the PRO Series Control Centre via a line I/O unit.	

Tab name	Section	Description	Example
----------	---------	-------------	---------

Ins Sends
(Insert Sends)

From

The **Ins. Sends** (Insert Sends) tab allows any of the input and output channels to be routed, primarily to an effects device (internal or external).

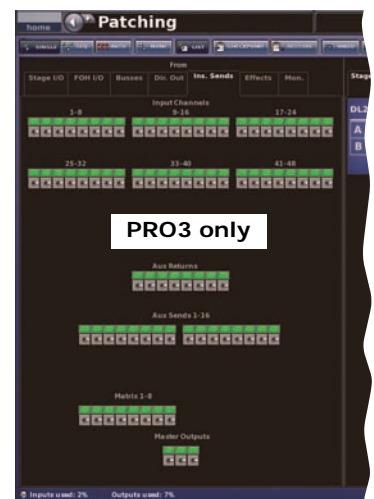
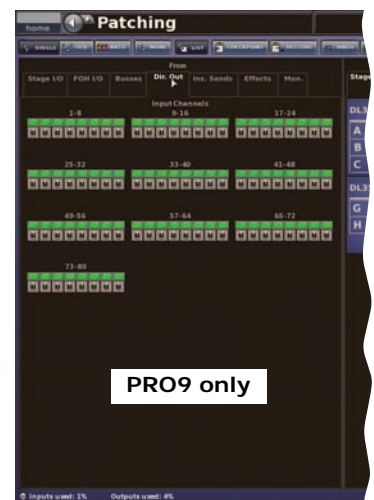

Tab name	Section	Description	Example
----------	---------	-------------	---------

Effects

From

The **Effects** tab allows patching from any of the internal effects. Each effect can support up to eight inputs and outputs, depending on which effects device is loaded. Stereo effects use the first two inputs/outputs.

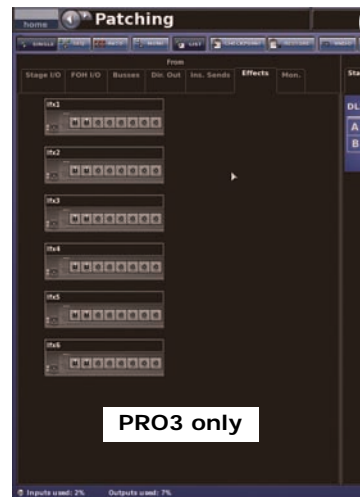
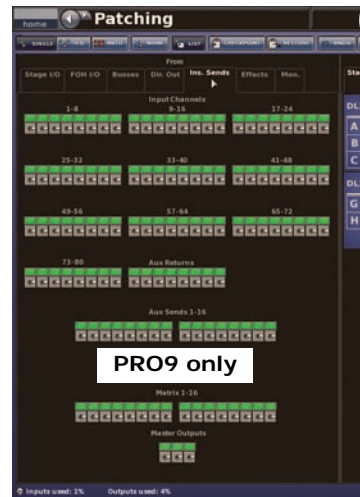
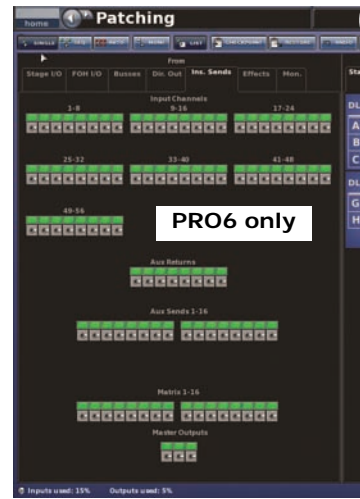

Tab name	Section	Description	Example
----------	---------	-------------	---------

Mon. (Monitor) **From**

The **Mon. (Monitor)** tab allows routing of the monitor outs (A and B) and external talk. These can also be found on the **Monitors** screen (see Figure 20 “Monitor A and B strips” on page 144) as shown in Table 5 “Monitor inputs and outputs on the Monitors screen” on page 85.



Stage I/O **To**

Although this is the equivalent of the **Stage I/O** tab in the **From** section, this one does not contain any mic splitters, as they don't supply any inputs to the PRO Series Control Centre. Refer to “To access the Patching screen” on page 73 and “System components” on page 14.

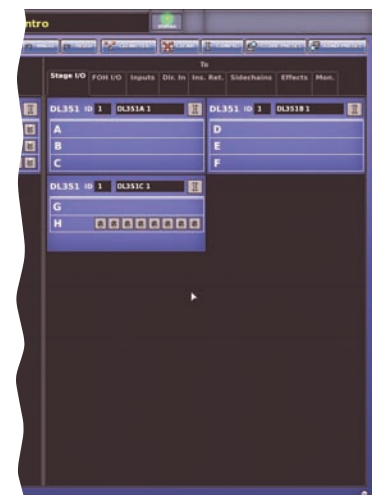
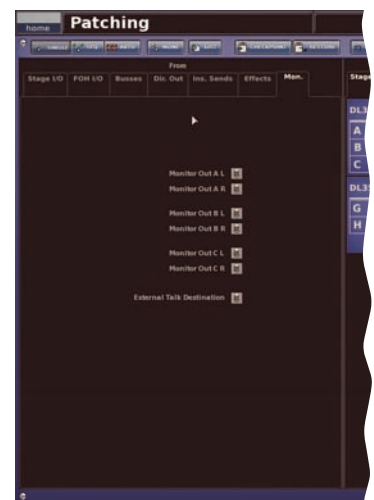

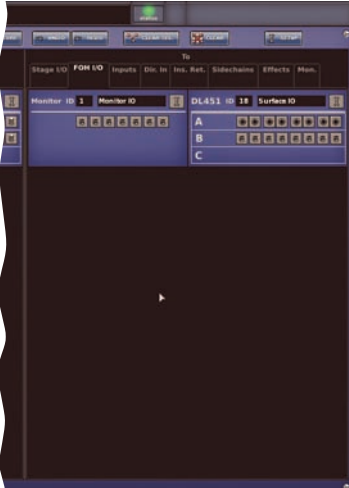
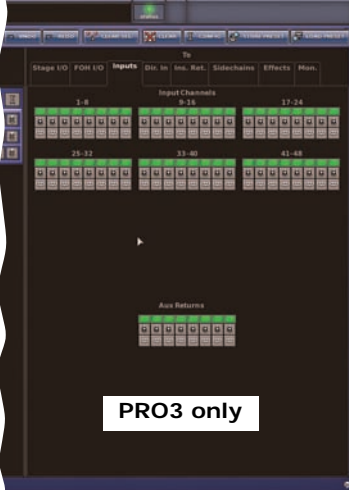
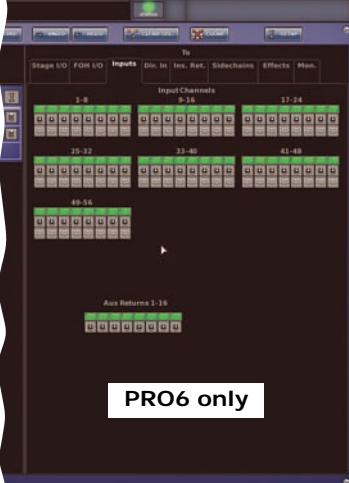
Tab name	Section	Description	Example
FOH I/O	To	<p>This tab is the equivalent of the FOH I/O tab in the From section.</p> <p>For information on what devices can be fitted in the I/O rack, see “About the devices on the stage and FOH I/O tabs” on page 85.</p>	
Inputs	To	<p>The Inputs tab allows sources to be routed to the input channels, tape returns and aux returns. This tab controls all of the input channels and the eight Aux Returns (returns).</p>	 <p style="text-align: center; border: 1px solid black; padding: 2px;">PRO3 only</p>  <p style="text-align: center; border: 1px solid black; padding: 2px;">PRO6 only</p>

Tab name	Section	Description	Example
----------	---------	-------------	---------

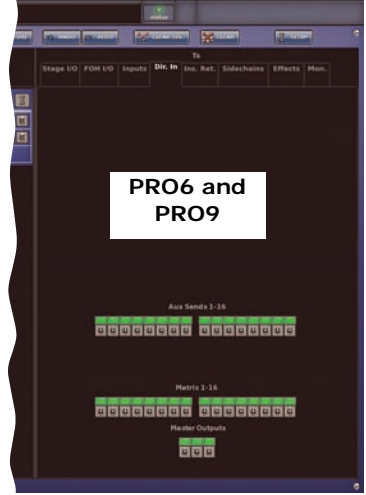
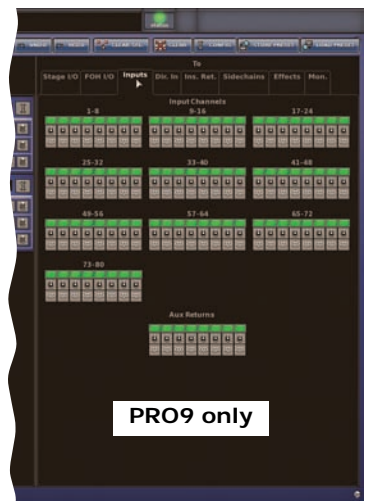

Dir. In (Direct Input) **To**

The **Dir. In** (Direct Input) tab lets you patch, for example, effects to the outputs. A signal connected to a direct input can access the dynamics and EQ processing available on that output. This allows the aux bus masters to be used as additional input channels.

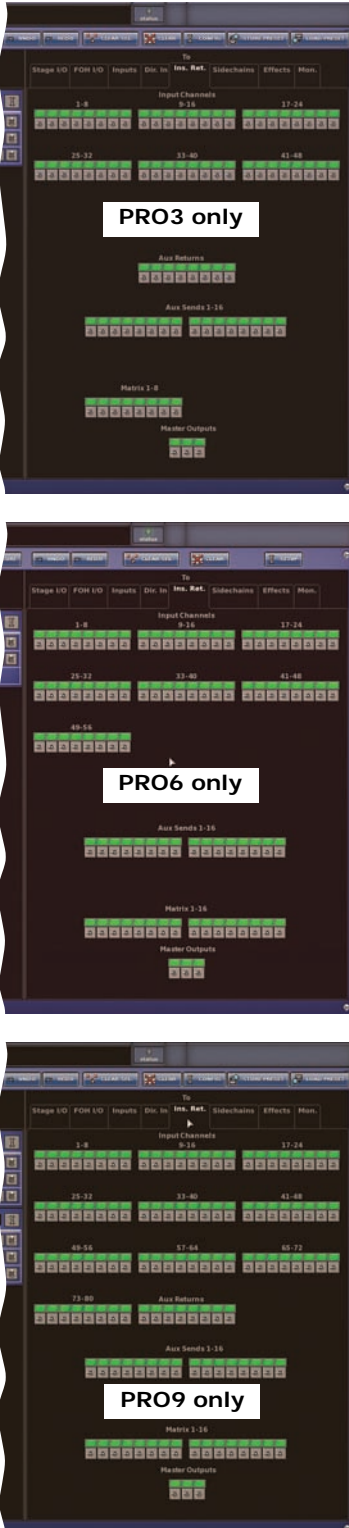

Tab name	Section	Description	Example
Insert Ret. (Insert Return)	To	The Ins. Ret. (Insert Return) tab allows insert returns to be patched to any of the inputs and outputs.	 <p>The example column contains three screenshots of the Midas software interface, each showing the 'Ins. Ret.' (Insert Return) tab for a different PRO model. The screenshots are labeled 'PRO3 only', 'PRO6 only', and 'PRO9 only'. Each screenshot displays a routing matrix with columns for 'Stage I/O', 'FOH I/O', 'Inputs', 'Dir. In.', 'Ins. Ret.', 'Subchannels', 'Effects', and 'Mon.'. The 'Ins. Ret.' column is highlighted, and the matrix shows various routing options for different channel ranges (e.g., 1-8, 9-16, 17-24, etc.).</p>

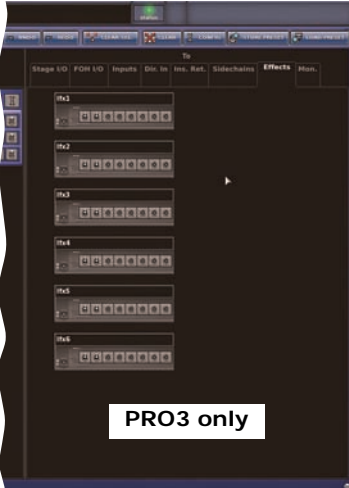
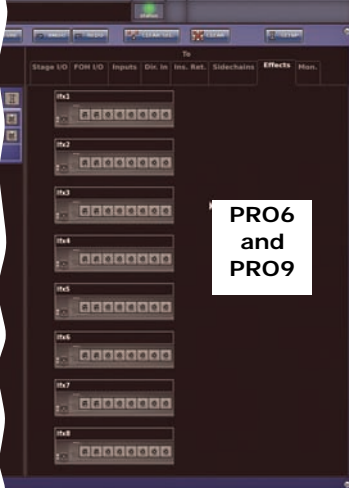
Tab name	Section	Description	Example
Sidechains	To	The Sidechains tab allows patching to the compressor and gate of the input and output sidechains (see "Side chain" on page 296).	 <p>The example column contains three screenshots of the 'Sidechains' patching screen in a software interface. Each screenshot shows a grid of patching options for different stages and channels. The first screenshot is labeled 'PRO3 only' and shows a grid with columns for Stage ID (1-8), Input Channels (9-16, 17-24), Aux Sends (1-16), Matrix (1-8), and Master Outputs. The second screenshot is labeled 'PRO6 only' and shows a similar grid but with an additional column for Input Channels (49-56). The third screenshot is labeled 'PRO9 only' and shows a grid with an additional column for Input Channels (77-80). All screenshots have a dark background with green and white text and icons.</p>

Tab name	Section	Description	Example
Effects	To	The Effects tab allows patching to all of the effects.	
			
Mon. (Monitor)	To	The Mon. (Monitor) tab allows routing to the communications and monitors. These can also be found on the Monitors screen (see Figure 20 “Monitor A and B strips” on page 144) as shown in Table 5 “Monitor inputs and outputs on the Monitors screen” on page 85.	

The following table lists the patching connectors on the **Mon.** tabs in the **From** and **To** sections, and shows their equivalents on the **Monitors** screen.

Table 5: Monitor inputs and outputs on the Monitors screen



<i>Mon. tab</i>	<i>Input/output</i>	<i>Equivalent on the Monitors screen</i>
Monitor Out A L	Output	monitor A output L
Monitor Out A R	Output	monitor A output R
Monitor Out B L	Output	monitor B output L
Monitor Out B R	Output	monitor B output R
Monitor Out C L	Output	monitor centre output
Monitor Out C R	Output	monitor LFE output
External Talk Destination	Output	external talk output
Talk Input Source	Input	talk input
Talkback Input Source	Input	talkback input
Ext Input Source L	Input	external input L
Ext Input Source R	Input	external input R
PFL Direct Input Source	Input	pfl direct input
AFL Direct Input Source L	Input	afl direct input left
AFL Direct Input Source R	Input	afl direct input right







Navigating to the Patching screen

You can open the **Patching** screen from various other screens in the GUI menu, usually by clicking a **source** (source) or **dest.** (destination) button. When you click one of these buttons, not only will the **Patching** screen open, but the appropriate tab in the **From/To** section will be open as well. For a full list of patching routing on the PRO Series, see Table 25 “Navigating to the Patching screen” on page 418.

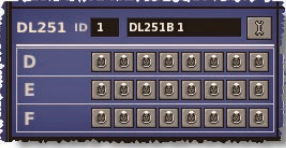
About the devices on the stage and FOH I/O tabs

The following device types will, if configured in the **AES50 Device Configuration** window (see Figure 14 “Typical AES50 Device Configuration window” on page 92), appear on the I/O tabs of the **From** and **To** sections of the **Patching** screen.

<i>Item</i>	<i>Device type</i>	<i>Description</i>	<i>Example</i>
AES50	Generic AES50	This is an audio only device that is used to represent the inputs and outputs of any third party AES50 device.	
DL251 Audio System I/O	DL251A	This device represents module card slots A, B and C of the DL251 unit.	

<i>Item</i>	<i>Device type</i>	<i>Description</i>	<i>Example</i>
	DL251B	This device represents module card slots D, E and F of the DL251 unit.	
	DL251C	This device represents the redundant AES50 port of the DL251 unit.	N/A
DL351 Modular I/O	DL351A	This device represents module card slots A, B and C of the DL351 unit.	
	DL351B	This device represents module card slots D, E and F of the DL351 unit.	
	DL351C	This device represents module card slots G and H of the DL351 unit.	
	DI351D	This device represents the redundant AES50 port of the DL351 unit.	N/A
DL431 Mic Splitter	Mic Splitter	For more information on this unit, refer to its operator manual (part number DOC02-DL431).	
	MS Cable Red	This device type is used to specify which port is to be used as a dual redundant port to a DL431 Mic Splitter.	N/A
DL451 Modular I/O	Line IO	For more information on this unit, refer to its operator manual (part number DOC02-DL451).	
	Line Io Cable Red	This device type is used to specify which port is to be used as a dual redundant port to a DL451 Modular I/O.	N/A

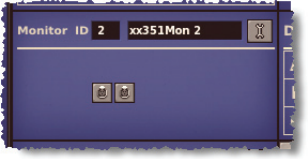
<i>Item</i>	<i>Device type</i>	<i>Description</i>	<i>Example</i>
DN9696	DN9696	Use up to four of these devices (with IDs 1 to 4) to represent the four AES50 ports for up to 96 channels of recording/playback. For more information on this unit, refer to its help manual (part number DOC02-DN9696HM).	
Monitor	N/A	This device represents the control surface monitor input and output XLRs. These are also shown on the Mon. tabs of the Patching screen, that is, the Talk Input Source and Talkback Input Source in the From section and all of those shown in the To section. Normally, these are always connected to the above patch connectors on the Mon. tabs. However, LFE and centre can be used as assignable outputs if surround monitoring is not required.	

Common device elements

The device images have certain common elements in their layout, as shown below.

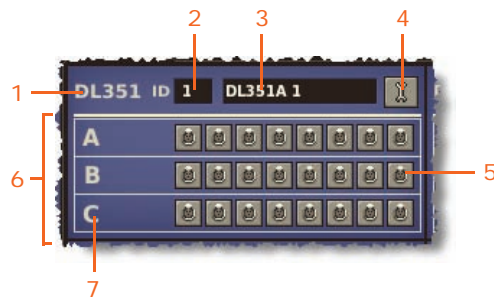

A typical device

<i>Item</i>	<i>Description</i>
1	Unit type.
2	Unit ID number.
3	Unit name and PRO Series Live Audio System-assigned unit number.
4	'Spanner' button, opens the device configuration window (see "Configuring the devices" on page 89).
5	Patch connector.
6	Patch connector area. (The line I/O device shows the three module card slots, A, B and C.)
7	Module slot reference.

Patching tooltips

Patching uses two types of tooltip — standard and list — to convey useful patching information about the patch connectors. A tooltip is a transitory object, in the form of a text box, that only appears while the GUI's pointer is in the proximity of a patch connector.

Standard tooltip

The standard tooltip is the default type that appears during all patching operations (unless the list tooltip is selected). The following diagram shows, typically, the type of information provided by a standard tooltip.

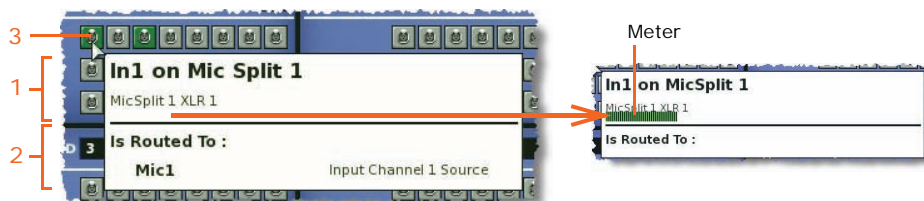

Typical standard tooltip

Item	Description
1	Patch connector information panel, contains information on the selected patch connector, such as, name, ID, device name, device ID etc. Depending on the device type, a signal level meter appears if the channel is passing audio.
2	Routing information panel, contains patching information on the selected patch connector. (If this panel is blank, the patch connector is not patched.)
3	The patch connector that the tooltip belongs to.

List tooltip

If you are carrying out a sequence operation, you can use the list tooltip to help in selecting the destinations in the **To** section. This tooltip, which has a distinctive translucent orange background, displays a list of the sources still to be patched. The list is in order of selection, with the first in the queue being at the bottom. You can only use the list tooltip for sequence operations.

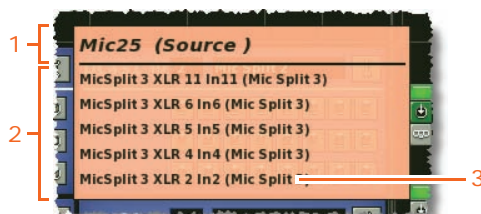

Typical list tooltip

<i>Item</i>	<i>Description</i>
1	ID of the patch connector belonging to the tooltip. If selected, this patch connector will be patched to the source patch connector at the bottom of the list.
2	List of selected sources still to be patched. Contains channel and device ID information.
3	This source patch connector is the one waiting to be patched. Once patched, this will disappear from the list and the one immediately above will take its place.

>> To select the list tooltip

Press **LIST**. (Pressing **LIST** again will change the tooltip back to the standard type.)

About the patching procedure

Although patching can be thought of as routing/rerouting the control centre's incoming, internal and outgoing signals, in the context of the **Patching** screen, patching also encompasses the setting up and configuration of the stage and FOH rack I/O devices. The patching procedure is initially carried out after system installation and comprises:

- **Device configuration** Configure the devices by adjusting their parameters (see below).
- **Snake selection** Configure the control centre according to the type of 'snake' you are using for the X and Y networks (see "Configuring the snake type" on page 92). **This is important, as the control centre will not work unless the snake type is correctly configured.**
- **Setting up the I/O rack devices** Set up the system devices, such as line I/O, DN9696 and generic AES50, in the I/O tabs in the **From** and **To** sections of the **Patching** screen (see "Setting up the I/O rack devices" on page 92).
- **Patching** Carry out all of the required routing, for example, mics to input channels (see "How to patch" on page 94).

Configuring the devices

You have the option to configure the devices from the **Patching** screen. Parameters, such as gain and +48V phantom voltage, can be adjusted or switched on/off, respectively, via a device-specific configuration window.

These configuration settings can be independent of channel data, as (until patched) they only control the physical unit. If a device is subsequently patched to one or more channels, the channel(s) control the device, and vice-versa.

The device configuration area also allows control of audio parameters when the device is used as a direct connection to another device. For example, FOH to stage via a digital snake, instead of through the DSP. In this case the settings are also saved in the show file and can be automated, even though the signals are not routed through the control centre DSP.

About the configuration window

The configuration window, which has a similar format for each device, comprises eight channel panels and drop-down lists for channel range/card selection.

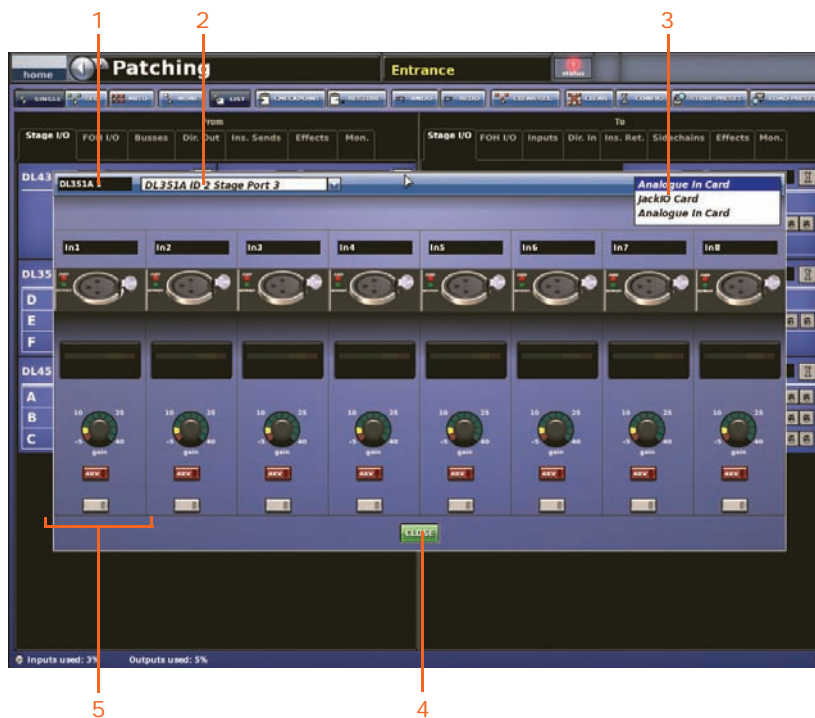

Typical device configuration window

Item	Description
1	Device ID field, contains the device type and number.
2	Device drop-down list, for device selection.
3	Channel range/card selection list.
4	CLOSE button, closes the configuration window.
5	Channel panel, contains device-specific controls and graphics.

Device configuration procedure

Although the procedure for configuring the devices is similar, their parameters are dependent on device type. The procedure for configuring the devices of a similar type involves:

- Opening the configuration window of the device.
- Selecting one of the device's cards/channel ranges and configuring the available parameters.
- Repeating for the other cards/channel ranges of the device.
- Repeating for the other devices.
- Closing the device's configuration window.

Note: As the set-up procedure is similar for each device (although some of the options may vary), only the one for DL351 Modular I/O is detailed in this section.

>> To open the configuration window of a device

Click the device's spanner button.



>> To set up/change the configuration of an I/O device

- 1 Open the configuration window of the I/O device you want to configure.
- 2 Select the I/O device from the drop-down list at the top of the configuration window.



- 3 Select the card/channel you want to configure/change, from the drop-down list at the upper-right corner of the configuration window. For example, the "Analogue In Card".



- 4 In a channel, configure the parameters. For example, in channel "In1", adjust the gain and switch the +48V phantom voltage on (shown right).
- 5 Repeat step 4 for the other channels in the card.
- 6 Repeat step 3 to step 5 for the other cards.
- 7 If necessary, configure other I/O devices by repeating step 2 to step 6.
- 8 Click **CLOSE**.



Configuring the snake type

Important:

The snakes must be correctly configured before operating the control centre, as it will not pass audio or control data if the snakes are not configured correctly.

You can connect the DL371 Audio System Engine to the control centre with either copper or fibre-optic snakes. The control centre needs to be configured with this information before operation can begin.

>> To configure the control centre with the snake type information

- 1 At the GUI, choose **home** ▶ **Preferences** ▶ **General**.
- 2 Under the **Stage Link X** heading, click the **Fibre** or **Copper** option, according to whichever is fitted to the X network. For example, click the **Fibre** option (shown right). A selected option will contain a red circle.
- 3 Do the same for the Y network, under the **Stage Link Y** heading.

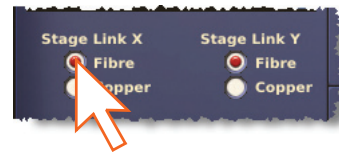

Setting up the I/O rack devices

You can add, remove and set up the devices, such as line I/Os, mic splitters, DN9696s etc., that are in the Stage I/O and FOH I/O racks. This is done via the **AES50 Device Configuration** window. Here, you can set up the device ID and also the type of cards (modules) fitted to the physical unit. The options are context-sensitive, so some may be blank, depending on the type of device.

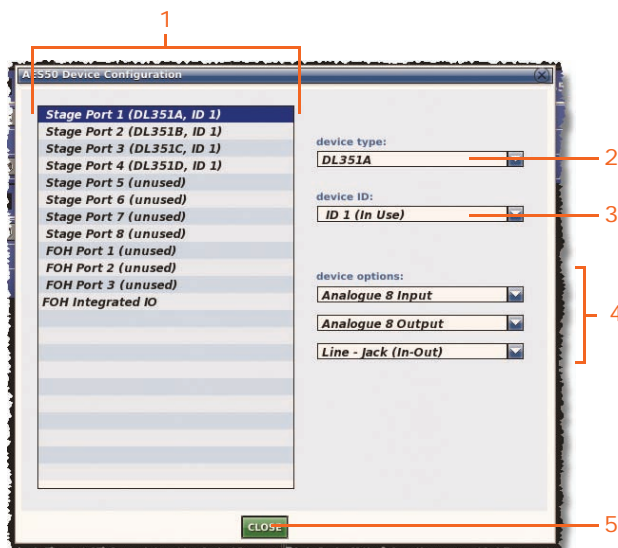

Figure 14: Typical **AES50 Device Configuration** window

Item	Description
1	List of Stage and FOH ports, showing current device assignments.
2	device type drop-down list, contains a list of the available devices to choose from (see “About the devices on the stage and FOH I/O tabs” on page 85).

<i>Item</i>	<i>Description</i>
3	device ID drop-down list, contains a full list of IDs for the selected device type. Those already in use will be prefixed with the text "(In use)".
4	device options drop-down list(s), from which you can select the card that is actually fitted in the physical unit. The positions of the drop-down lists are relative to the card positions in the physical unit.
5	CLOSE button, closes the AES50 Device Configuration window.

To cater for the dual redundant ports of the DL431 Mic Splitter and DL451 Modular I/O (X and Y connections) there are two options in the **device type** drop-down list, **MS Cable Red** and **Line To Cable Red**, respectively. Initially, the device is allocated to a port (as for any device), then a second port is allocated to the redundant connection, but with the same device ID (see below for details).

Device set-up procedure

The device set-up procedure comprises:

- Selecting the port (Stage or FOH) you wish to allocate the device to.
- Selecting the device type.
- Selecting an ID for the device.
- Selecting the options (if any) for the device.

>> To add a device or change its set up

- 1 Click **CONFIG** to open the **AES50 Device Configuration** window.
- 2 Click the port you want to allocate the device to. For example, "FOH Port 3 (unused)". The text in the **device type:** field will change accordingly. (A port that has no device allocated to it will have the text "(unused)" after its name.)
- 3 In the **device type:** drop-down list, click the type of device. For example, "DL351A".
- 4 In the **device ID:** drop-down list, click the ID you want for the device. For example, "ID6".
- 5 In the **device options:** drop-down list, click the type of card fitted physical unit. For example, "Analogue 8 Input". If there is more than one **device options:** drop-down list, repeat for the remaining ones, making sure they match the actual cards fitted.
- 6 Click **CLOSE**.

>> To remove a device

Select the port/device from the list in the left of the **AES50 Device Configuration** window. Then, select "None-Unknown" in the **device type:** drop-down list. For further details, see "To add a device or change its set up" on page 93.



>> **To add a DL431 Mic Splitter or DL451 Modular I/O device**

- 1 Set up the device (as detailed above), but select the **Mic Splitter** (for DL431) or **Line IO** (for DL451) option in the **device type** drop-down list as necessary.
- 2 Set up the device's redundant connection by selecting another port from the list in the left of the **AES50 Device Configuration** window. Select the **MS Cable Red** or **Line Io Cable Red** option in the **device type** drop-down list as necessary. Then, in the **device ID:** drop-down list, select the same device ID as the one you chose in step 1.
- 3 Click **CLOSE**.

How to patch

Patching, basically, involves selecting the source patching connectors in the **From** section of the **Patching** screen and then selecting their destination(s) in the **To** section. You can select patches singly, or in multiples by using the sequence and automatic operations.

Each patch connector has three possible states, as indicated by its fill colour. The following table shows what each state signifies (the examples show XLR connectors, although it applies to any type of patch connector).

<i>Symbol</i>	<i>Description</i>
	Patch connector is not selected and not patched.
	Patch connector is selected, but can be either in a patched or unpatched condition.
	Patch connector is patched, but is not selected.

Working with patch connectors

You can select patch connectors one at a time by clicking on them, or you can select them in blocks by using a drag operation. All of the patch connectors in both the **From** or **To** sections are on tabs so, before you can select a patch connector, its tab must be open.











>> **To open a tab in the From or To sections**

Click the tab title. For example, click **Ins. Sends** to open the insert sends tab.

>> **To select a single patch connector**

Click the patch connector. The effects of clicking a patch connector are shown in the following table.

Table 6: Effects of clicking a patch connector

<i>Clicking</i>	<i>Does this in the From section</i>	<i>Does this in the To section</i>
	Selects patch the connector.	 Will do one of the following (provided a source patch connector(s) has been selected in the From section): <ul style="list-style-type: none"> • Selects the patch connector during a single patching operation.  • Patches the patch connector during either a sequence or an automatic patching operation.  Otherwise, this has no effect.
	Deselects the patch connector, which then reverts to its previous state (patched or unpatched).  OR 	Removes the patch. 
	Selects the patch connector and all the ones it is patched to in the To section. 	Removes the patch. 



*To quickly check the destinations of a source patch connector, click it. This will select it and all of its destinations. A green triangle will appear under the name of any tab in the **To** section that contains a destination(s).*

>> **To select a block of patch connectors in the From section**

Use a drag operation (see “Drag” on page 53) to create a bounding box around the block of connectors you want to select (shown right).

This procedure can only be done using sequence and multi-patching operations (initiated by the **SEQ.** and **AUTO** buttons, respectively).



>> **To deselect all selected patch connectors**

Click **NONE**.

>> **To remove a single patch**

In the **To** section, click the patch connector from which you want to remove the patch.

>> To remove all the patches of a single source

- 1 Make sure that no patch connectors are selected. If necessary, click **NONE**.
- 2 In the **From** section, click the source patch connector from which you want to remove all of the patches. (This will select the source patch connector and also all of its destinations.)
- 3 Click **CLEAR SEL.**

>> To remove the patches from all selected patch connectors

Click **CLEAR SEL.**

>> To clear a block of patch connectors

- 1 Click **NONE**.
- 2 In the **From** section, select the patch connectors you want to unpatch.
- 3 Click **CLEAR SEL.**
- 4 Click **NONE**.

Single patching (SINGLE)

The **SINGLE** function button lets you patch a single source to a single destination or multiple destinations.

>> To patch a single source to a single destination

The following example shows you how to patch an output from a mic splitter to an input channel.

- 1 Click **SINGLE**.
- 2 Select the source patch connector. For example, in the **Stage I/O** tab of the **From** section, click the first patch connector (XLR1) of card A of the DL351 Modular I/O. Its background will change to yellow and a green triangle will appear under the tab title (as shown right).



- 3 Select the destination patch connector. For example, in the **Inputs** tab of the **To** section, click the patch connector for input channel 14 (Mic14). It will now be patched to the source. If the new patch is carrying a signal, this audio may be heard, depending on the settings of the control centre.



Note: You can also carry out single patching operations using the **CLEAR SEL.** and **AUTO** functions.

>> To patch a single source to multiple destinations

- 1 Patch the desired source patch connector to one of its destinations, as detailed in “To patch a single source to a single destination” on page 96.
- 2 In the **To** section, select the other destinations.

Sequence patching (SEQ.)

If you need to do a number of patches, and each has only a single destination, you can use the sequence function. All of the source patch connectors are selected in the **From** section before being patched, one by one, in the **To** section. This saves you having to go back to the **From** section at the start of each patch.

To assist you in sequence patching, you can change the tooltip to the list type (see “List tooltip” on page 88).

Automatic patching (AUTO)

You can patch a block of source patch connectors, just by selecting a single destination. This is called “automatic patching”. When using automatic patching, note the following:

- Sources are selected in blocks (see “To select a block of patch connectors in the From section” on page 95).
- You can only select one block of sources at a time.
- Destinations are restricted to a single type.
- The selected destination forms the start of the automatically patched range of destinations.
- Sources and destinations are automatically patched in ascending order, the lowest numbered source and the selected destination forming the first patch.
- Sources will only be patched up to the highest numbered destination of the current destination type. If there are any sources left over, automatic patching pauses. You can then patch these by selecting another destination.

>> To automatically patch a block of source channels

- 1 Click **AUTO**.
- 2 In the **From** section, select the source patch connectors (see “To select a block of patch connectors in the From section” on page 95).
- 3 In the **To** section, choose the destination patch connector that will form the start of the automatic patching range. For example, input channel 3 (Mic3).
- 4 Click the destination patch connector. The sources will be patch in numerical sequence and in ascending order from here onwards.

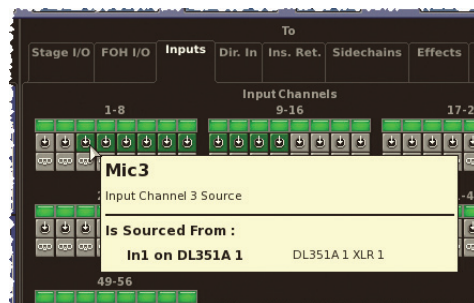

Clearing all current patching



Caution:
The **CLEAR** function button clears all current patching, and must be used with great caution. To alert you of the drastic nature of using this button, a **WARNING** appears.

>> To clear all current patching

- 1 Click **CLEAR**. The **WARNING** window (shown right) will appear.
- 2 Heed the warning and do one of the following:
 - If you want to clear all current patching, click **OK**.
 - To cancel the clear operation and close the **WARNING**, click **CANCEL**.

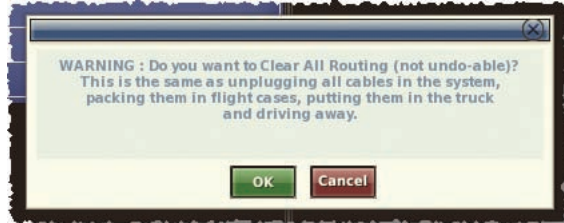

Chapter 9: Basic Operation

This chapter is intended to familiarise you with the control centre by showing you how to carry out some basic operations in order to get some audio out of it.

Note: As the operation of both input bays is principally the same, this chapter will generally only show the operation of the 12-channel input bay. However, any differences in operation between the 4-channel and 12-channel input bays will be highlighted.

Please don't forget that, although this system is a complex, high-tech piece of equipment, it is very easy to use.

Setting a mic amplifier's input gain

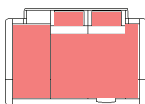

The control centre has two input gains per channel, one is the remote gain for the analogue mic pre (stage box gain) and the other is the digital trim (console gain) (see "Mic amp input gain (preliminary input processing)" on page 286). In its default state, the stage box gain is in the channel strip and the console gain is in each input fast strip. However, you can swap these sections over (by pressing the gain swap button) to give you a more global control of the stage box gain.

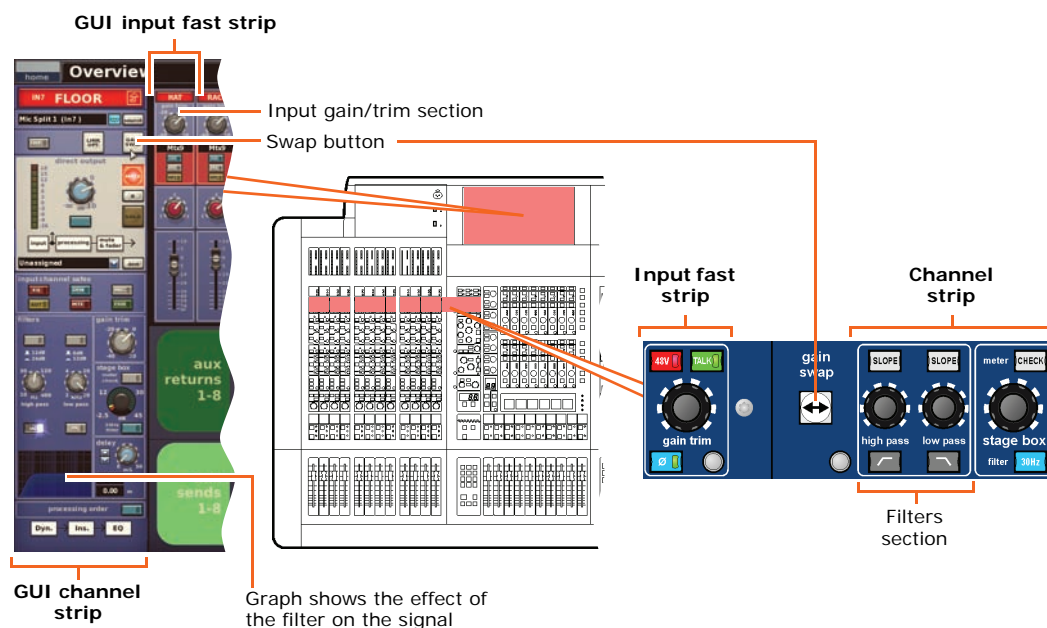

Figure 15: Gain and filter sections of the input strips

Note: The **gain trim** and **stage box** control knobs on the control surface will adjust whatever has been 'swapped' to their respective strips and not necessarily what their names suggest. The **stage box** control knob (channel strip) always controls the alternative 'swap' to the ones shown in the input fast strips on the GUI screen.

>> To set the stage box gain/console gain

- 1 In the **gain trim** section of an input fast strip, press the quick access button (see Figure 15 “Gain and filter sections of the input strips” on page 99). This selects the input channel and assigns its configuration processing area to GUI channel strip, which contains the **GAIN SWAP** button.
- 2 Press the left-right arrow gain swap button (or click **GAIN SWAP**) to swap the **gain trim** and **stage box** sections over. The diagram right shows an example of each section.
- 3 Adjust the **gain trim** control knob (5dB steps from -2.5dB to +45dB) to the required level to suit the Midas pre-amp characteristic. A suitable level could be one that only just illuminates the yellow LEDs. Do this for each required channel. Drive the mic amps for that ‘Midas colouration’; feel free to overdrive if you want.
- 4 After you have achieved the required gain state, press the left-right arrow gain swap button (or click **GAIN SWAP**) to swap the gains back to their default state.
- 5 Adjust the **gain trim** control knob to (this time) adjust the console digital trim (+20dB to -40dB continuous trim) for your preferred gain structure.
- 6 Set analogue remotes for initial set-up, then adjust digital trim for showtime.



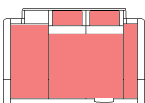

Setting the high and low pass filters



Select high and low pass filters. The high and low pass filters can be switched on/off and, when on, each has two settings. The filters are replicated on the GUI, which also shows the value of the filter in operation.

>> To set both high and low pass filters in

- 1 In the **gain trim** section of an input fast strip (see Figure 15 “Gain and filter sections of the input strips” on page 99), press the quick access button. This selects the input channel and assigns its configuration processing area to the GUI channel strip, which contains the **filters** section.
- 2 In the **filters** section of the input channel strip, press the filter select button (**high pass**  or **low pass** ) to switch the filter in.
- 3 If necessary, press the filter’s **SLOPE** button to set its slope (dB); its status is shown on the GUI. For the high pass filter, in = 24dB and out = 12dB, and for the low pass filter, in = 12dB and out = 6dB.
- 4 Adjust the **high pass/low pass** control knob to set the filter frequency (Hz). The ranges are 10Hz to 400Hz for the high pass filter and 2kHz to 40kHz for the low pass filter.

Input equalisation (E zone)

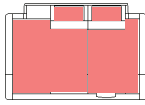

Use EQ to equalise the input signal via the treble, hi-mid, lo-mid and bass filters, which are situated in the input channel strip's E zone. Treble and bass each have a parametric filter option and three specific shelving modes. Visual feedback for EQ is via GUI only.

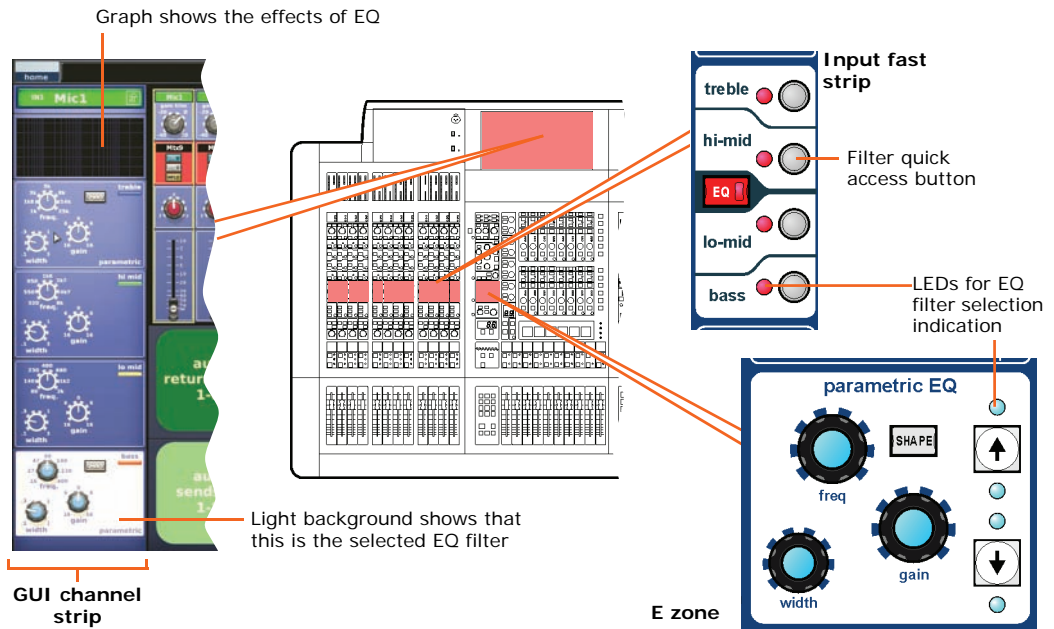

>> To EQ the input signal

- 1 In an input fast strip, press the quick access button of the desired EQ filter (**treble**, **hi-mid**, **lo-mid** or **bass**). This will select the channel and open the EQ filter's processing area in the GUI's channel strip. Alternatively, you can navigate to it using the bass and treble up and down arrow buttons in the E-zone (shown above).
- 2 In the input fast strip, press **EQ** to switch the EQ in. The **EQ** button's LED will illuminate when its EQ is switched in.
- 3 In the E zone, adjust the **freq**, **width** and **gain** control knobs to apply EQ as desired.
- 4 Audition the different filters, including the 'minimum harmonic disruption' types, by scrolling through them using the **SHAPE** button.

Note: The minimum harmonic disruption filters are **bright** and **deep**, which are available for treble and bass, respectively. These filters use psychoacoustic phenomena to generate steep slopes that sound natural.

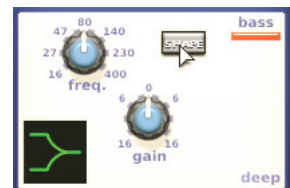

Input dynamics processing (D zone)

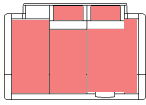

Set up compressor and gate dynamics processors using the controls in the input channel strip's D zone.

There are four compressors available, corrective, adaptive, creative and vintage, each with the option of hard knee, medium knee and soft knee (see "Compressor envelope modes" on page 343).

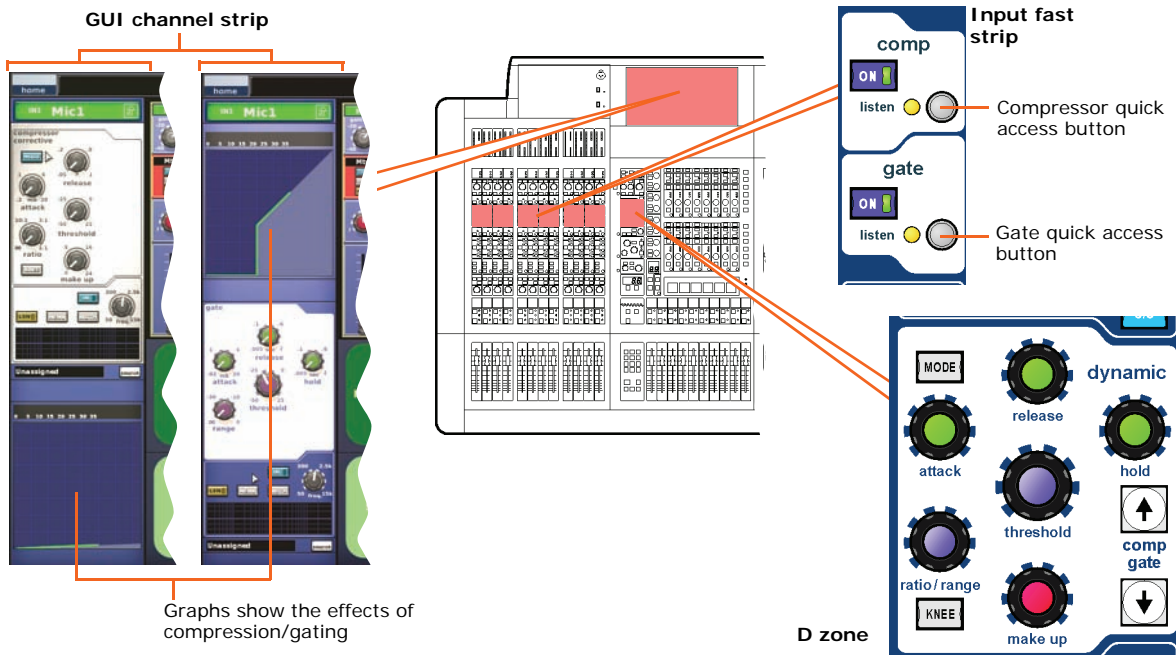

>> To set up a compressor/limiter

- 1 In an input fast strip, press the compressor quick access button in the **comp** section. This will select the channel and assign its compressor processing area to the GUI channel strip.
- 2 In the **comp** section, press **ON** to switch the compressor in.
- 3 In the D zone, operate the **attack**, **ratio/range** (ratio), **release**, **threshold** and **make up** controls to apply processing (see "Compressor" on page 290). You could also set up a limiter by using a high threshold and a steep ratio (greater than 5:1).

The **hold** control knob has no effect as it is only used for the gate.

- 4 Press **KNEE** to audition the different algorithms (hard knee, medium knee and soft knee as shown right).

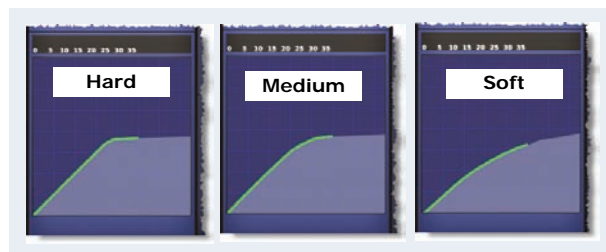

- 5 Press **MODE** to try different compressor types (**corrective**, **adaptive**, **creative** and **vintage**). For example, **creative** shown right.



>> To set up a gate

- 1 In an input fast strip, press the gate quick access button in the **gate** section. This will select the channel and assign its gate processing area to the GUI channel strip.
- 2 In the **gate** section, press **ON** to switch the gate in.
- 3 In the D zone, operate the **attack**, **ratio/range** (range), **release**, **threshold** and **hold** controls to apply processing (see "Gate" on page 294).
The **make up** control knob has no effect as it is only used for the compressor.

Output processing

Apart from the returns, which are similar to the input channel EQ, the outputs have a six-band PEQ with shelving modes on bands 1, 2 and 6. They also have the option of using a GEQ, which is accessed via the **GEQ** button in their EQ processing areas.

The outputs (except returns) have the same four compressor modes as the input channels, but with the addition of a shimmer mode.

Using VCA/POP groups

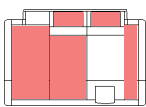

VCA/POP groups (bottom of the mix bay) allow simultaneous control over a number of channels. This provides a quick method of bringing particular channels to the control surface and saves you having to remember their name/number. You can choose channel group associations and also configure the colour and legend of each group's LCD select button to make them instantly recognisable. The LCD select button for each group is used for both group member assignment and group recall.

Any group can have any channels (input/output) assigned to them, although in normal practise is more likely that they will only have one or the other. Only input channel group members are unfolded to the surface (input bays).

VCA groups include fader, solo and mute control. However, POP groups — which have no audio function — are limited to unfolding channels (on area A or B). POP groups let you create a group of related instruments that you need on the control surface for some function.

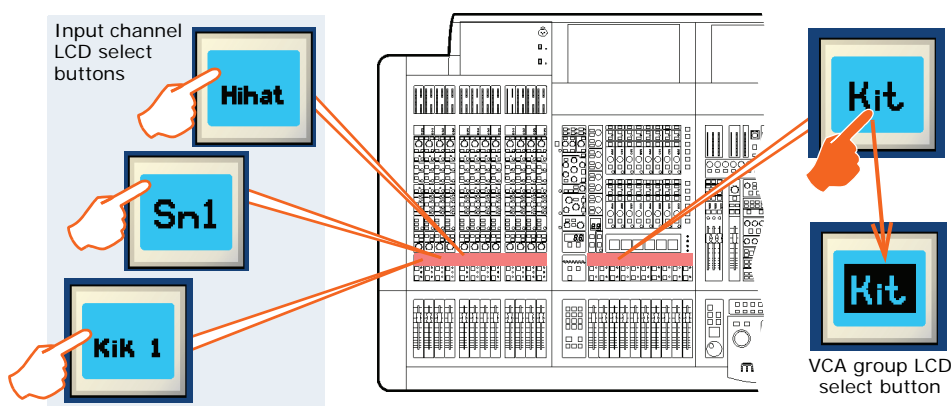

>> To assign channels to a VCA/POP group

- 1 Press and hold down the LCD select button of the desired group (VCA or POP). For example, "Kit" in the VCAs (as shown above). The group's LCD select button will start flashing when you are in group member selection mode and the inputs will jump to program mode. Any existing input channel group members will be unfolded to the control surface.
- 2 While still holding down the LCD select button, do one of the following:
 - To assign an input channel to the group, press the LCD select button of the desired input channel. Repeat for any other input channels you want in the group. For example, "Kik 1", "Sn1", "Hihat" and "Tom" (shown above). If necessary, scroll to a new bank of input channels.
 - To assign an output channel to the group, press the quick access button of the desired output channel. Repeat for any other output channels you want in the group. If necessary, navigate the desired output channels to the control surface. The quick access buttons of any output channels that are at the control surface and are group members will illuminate. Individual output select buttons will flash if their bank contains a member of the current group.
- 3 Release the group LCD select button. The group now contains the channel members you have just assigned and the group will be selected.
- 4 To exit the group, quickly press the group LCD select button.



*To quickly see which channels are in a particular VCA group, press its **SOLO** button on and off. Monitor this action on the **Meters** display (master bay GUI). Only the **SOLO** buttons of channels that are group members will be affected.*

Configuring VCA/POP groups



The default name and associated colour of a group, which appear on its LCD select button and on the GUI, can be configured to suit your own preference. You can also globally change the colour of the group members to match the group colour. Configuration is carried out at the **Group Sheet** screen (see Figure 16).

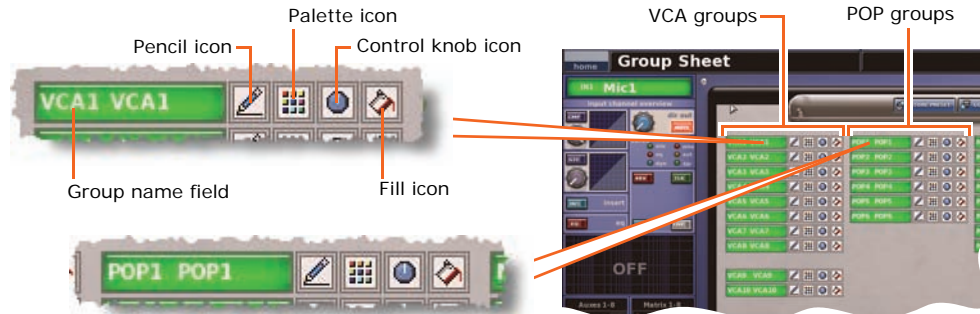



Figure 16: VCA/POP group fields on the **Group Sheet** screen

Note: Clicking the control knob icon  will take you to the **VCA Groups** screen (a submenu of the **Control Groups** option), which provides group management control.

>> To access the Group Sheet screen

Do one of the following:

- At the GUI, choose **home** ▶ **Control Groups** ▶ **Group Sheet**.
- In the primary navigation zone, press the **vca/assignable controls** screen access button.

>> To set up the name of a VCA/POP group

Do one of the following:

- **Choose from a list of pre-configured names** by clicking the pencil icon  of the group. In the drop-down list, click the name of your choice, for example, "E Gtr". Scroll the list, if required.
- **Type in a new name** by clicking within the name field of the group. The pointer will change to a white flashing I-shaped cursor, which will appear at the end of the name field. Type in the new name via the keyboard (maximum six characters).

>> To set up the colour of a VCA/POP group

- 1 Click the palette icon  of the group.
- 2 In the palette (shown right), click your chosen colour. For example, blue.

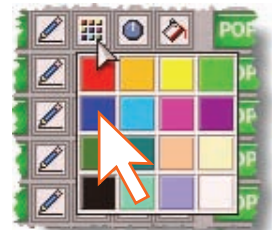

>> To set up the colour of a VCA/POP group and all of its members

Click the fill icon  of the group. The colour of all group members will now match that of the group.

Setting up a mix

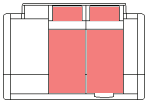

The control centre has up to 32 configurable mix buses (16 auxes and up to 16 matrices), each of which can be used as aux mixes, subgroups or mix minus. All of the mixes can also be set up as stereo pairs or mono. Eight matrix outputs can also be accessed directly from input channels via level controls, which gives the control centre the ability to provide up to 32 discrete mixes, plus left, right and mono. The **mix** sections (input fast strips) and the **mix** and **sends** sections (mix and master bays) provide mix control and navigation, while the bus mode selection is via GUI only.

Similarly to the inputs and groups, identification of mixes is by colour coding.

The overview displays in the GUI channel strip (see Figure 17) show the status of the mixes, which are colour coordinated to match those in the sends section of the control surface.

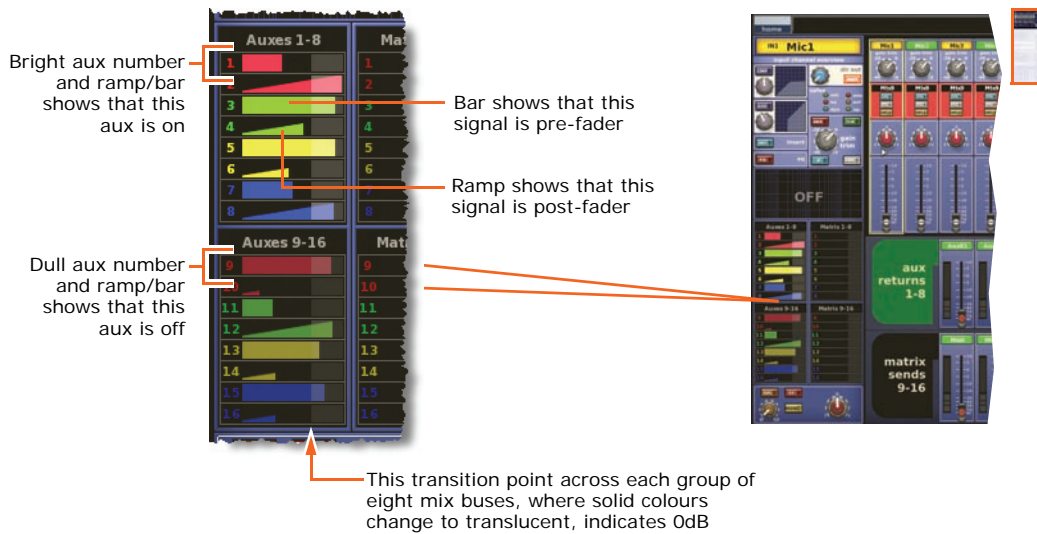
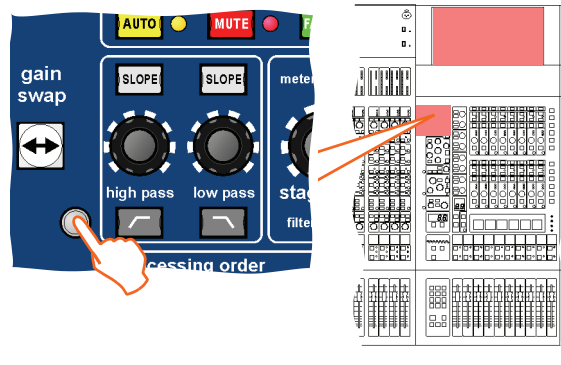

Figure 17: Typical sends sections of the mixes in the GUI channel strip

>> To select the mix bus mode

- 1 Select the mix bus (see "To select a mix bus" on page 65).
- 2 Press the quick access button (adjacent to the filters section) to assign the mix overview to the channel strip. For example, the **aux send overview** for Aux1.



- 3 Click a non-control area within one of the sections (for example, **dir in**) to open the configuration processing area in the GUI channel strip.



- 4 Click **MODE** repeatedly to scroll through the mix modes (**mix**, **group** and **mix minus**) to select the one you want. Group mode is fader only with no pre-fader, and in mix minus mode all buses are initially routed — you have to turn a bus routing switch on to take it out of the mix. Stereo mix mode — with mix selected and **LINK** button on — is only accessed from the odd numbered output channel of the linked pair. In stereo mix mode the top control knob becomes pan adjust and the bottom one adjusts level.



When creating a stereo mix, you can use either the odd or even output to link the two channels, but the mode of the odd channel is used on both.

>> To set up a mono aux mix

- 1 Making sure that the mix bus is not linked, select **mix** (see “To select the mix bus mode” on page 106).
- 2 Select the input channel (see “To select an input channel” on page 62).
- 3 At the GUI, click within the appropriate sends section (aux or matrices) in the overview display (see Figure 17 on page 106) to open its processing area.



- 4 In the **mix** (upper) section, do the following:

- a Press **PRE** to select pre-fader (on) or post-fader (off). Button status is only available on the GUI (see Figure 17 on page 106).
- b Press **ON** to route the aux mix from input to aux output.
- c Adjust the level control knob to change the signal level. You have the option to adjust them using the pan/fader controls in the input fast zone (12-channel input bay); this is known as “flip” mode. (You can also adjust them in the GUI channel strip — overview or processing area — using drag.)

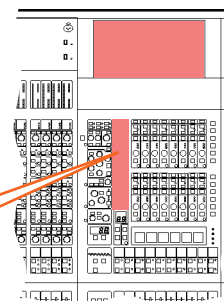
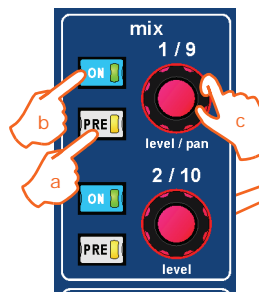

Mix bus routing

You can route an aux or matrix (or even master output) to an effect or output. This is a GUI-only operation, which is done via the GUI channel strip or **Patching** screen (see Chapter 8 "Patching").

>> To route an aux or matrix to an effect or output

Do one of the following:

- In the processing area of the channel strip, click the required mix bus destination from the drop-down list. For details of how to open the processing area, refer to "To select the mix bus mode" on page 106.



- In the processing area of the channel strip, click **dest** (shown right). This will open the **Patching** screen and the appropriate tab. For details of how to open the processing area, refer to "To select the mix bus mode" on page 106.
- Open the **Patching** screen and route the aux/matrix from there. For information on patching, see Chapter 8 "Patching" on page 71.



Linking

You can link two mixes together. Pairs can only be created from adjacent mix buses of the same colour. To link a pair of mix buses, click the **LINK** button of either of the mix buses (odd or even) you want to link (see "To select the mix bus mode" on page 106).

The linked parameters default to the user-configurable global default link settings, which are set via the GUI menu (choose **home** ▶ **Preferences** ▶ **Linking**). However, you can override these default link settings for the pair via the **Stereo Linking Options** window, which is opened by pressing the **LINK OPT.** button (to the right of the **LINK** button).

For more details, see Chapter 10 "Stereo Linking" on page 127.

Using fader flip

For information on using fader flip, see "Controlling the mix buses in flip mode" on page 48.

Note: When using fader flip to control the aux bus levels, always use the GUI to check the level. This is because the fader level markings have a maximum of +10dB, whereas the aux bus levels only go up to +6dB.

Setting up the effects rack

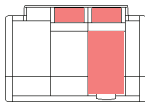

The GUI's **Effects** screen contains a virtual eight-unit rack. You can have a maximum of eight effects units in the rack, the number being dependent on configuration. Each unit can contain any combination of the effects listed in the **Change Device Type** window. (The PRO3 only has up to six effects units.)



The **assignable controls** panel (shown in the **Delay** diagram below) is common to all effects, and lets you control effect parameters via the equivalent panel on the control surface (master bay).

Delay — provides simple delay line-based effects. Delay times can be specified manually or you can use the 'tempo-tap' button. It has a three-mode delay algorithm: one delay tap (mono or stereo processing); dual - two delay lines (stereo inset only); and ping-pong - two delay lines with cross feedback.



DN780 — is a reverberation device that emulates the Klark Teknik DN780 Digital Reverberator/Processor unit and lets you create unique acoustic environments of virtually any type.



Flanger — has one or, if configured as stereo, two tap delay lines. One tap is fixed and the other tap position is modulated to provide 'thru-zero' flanging or single tap modulation when 'thru-zero' is off.



Phaser — has one, or if configured for dual operation, two stereo phasers connected in serial or parallel, according to mode setting.



Pitch Shifter — has two independent channels that can independently shift the pitch of signals up or down to correct poor pitching or generate harmonies. The pitch change can also be modulated as an effect.



SQ1 Dynamics — is an emulation of the Klark Teknik Square ONE Dynamics, which is an 8-channel analogue dynamics processor. Used for the precise manipulation of compression parameters, it also includes gating for creative and corrective applications, and channel linking for stereo/multi-channel operation.



3 Band Compressor — is a minimum phase shift (analogue style) implementation that guarantees coherent band summing, even at the most extreme crossover point settings. Each band provides full control of its compressor's action, with partially adaptive time constants ensuring the most natural results from even the most variable sources.



>> **To choose an effect**

- 1 At the GUI, choose **home** ▶ **Rack Units** ▶ **Effects**. Alternatively, press the **effects/graphics** screen access button in the primary navigation zone.
- 2 Click within your chosen rack position. This will be the position of the new effect.



- 3 In the effect window, click **CHANGE DEVICE TYPE**.

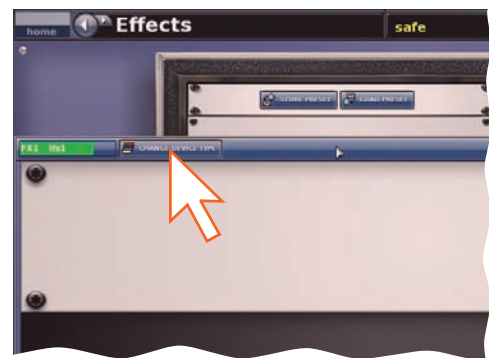

- 4 In the **Change Device Type** window, click your chosen device type. For example, "DN780".
- 5 Click **OK**.

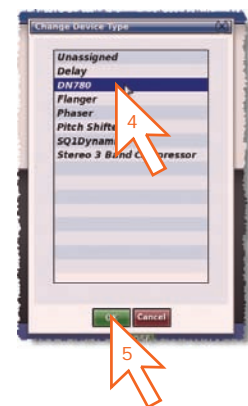

- 6 Change the parameters of the new effect device as necessary. For example, adjust control knobs, press buttons etc. You can even change the effect's name by editing its name field (upper-left corner of effect window).



- 7 Click **CLOSE** to close the effect window. The new effect will appear in the effects rack.

You can now patch the new effect, which will be on the **Effects** tabs of both the **From** and **To** sections of the **Patching** screen. For information on how to patch, see Chapter 8 "Patching" on page 71.



Simple routing to master stereo outputs

The following shows you how to obtain audio. Before proceeding with this operation, make sure nothing is muted and master faders are up.

>> To obtain audio

Do one of the following:

- Press the **ST** (stereo) button of an input fast strip.
- Press the **ST** (stereo) button of a channel strip.

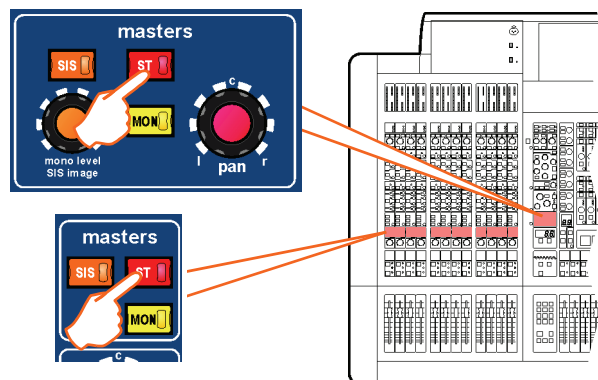

Scene and show management (automation)

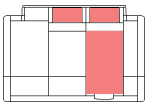

Automation lets you manage show files and the scenes within the shows. This can all be done via the **Automation** screen (a GUI menu option).

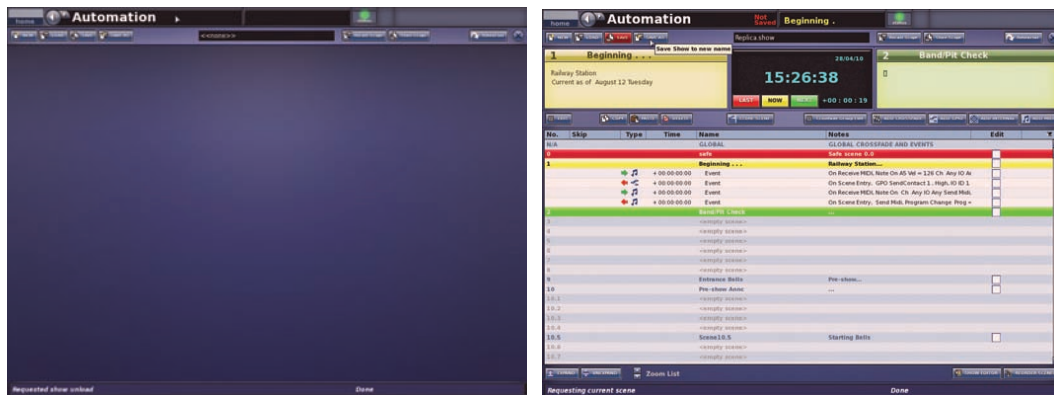

Typical **Automation** screens before (left) and after (right) a show has been initially loaded

>> To open the Automation screen

Do one of the following:

- At the GUI, choose **home ▶ Automation ▶ Automation**.
- In the primary navigation zone, press the **automation/filing** screen access button.

Managing the shows

The four buttons (**NEW**, **LOAD**, **SAVE** and **SAVE AS**) towards the top of **Automation** screen let you create a new show, load an existing show, update the current show or create a new show using the current settings.

Important:

We recommend that you save your show settings regularly (see "Saving a show versus storing a scene" on page 49). The control centre will indicate that there are show settings to be saved by changing the background colour of the **SAVE** button to red (as shown right).

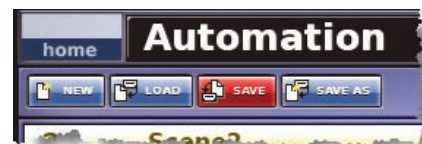

>> To create a new show

- 1 Click **NEW**.
- 2 In the **Enter new show name:** window, type your chosen name for the new show.



- 3 Click **OK**. You can now create and manage the scenes for your new show. (Clicking **CANCEL** instead of **OK** will close the **Enter new show name:** window without creating a new show.)



>> **To save a show or create a new one from the current settings**

Do one of the following:

- To update the current show with the latest settings, click **SAVE**.
- To create a new show using the current show settings, click **SAVE AS**. Then, in the **Save File** window, type in the name of the new show. Click **OK** to save the new show and close the window. (Clicking **Cancel** will close the window without saving the new show.)



>> **To load a show**

- 1 Click **LOAD**.
- 2 In the **Load File** window, click the show file you want to load (shown right). The file name will appear in the **Load this file:** name field.

The **Load File** window will contain a list of all the shows currently loaded. If the one you want is not there, load it from a USB memory stick (see "To load (import) a show file from a USB memory stick" on page 123).

- 3 Click **OK** to start loading the file and close the window. The show file name will appear in the show file name field (next to the **SAVE AS** button) when it has finished loading.

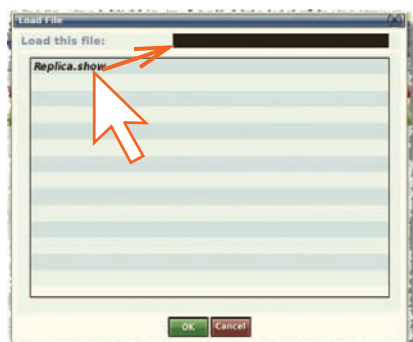

Managing the scenes

An automation section in the master bay (see item H in Figure 5 “Main areas of the control surface” on page 29) supports the **Automation** screen by providing a number of controls for scene navigation and management. A jogwheel and a **next** LCD button are unique automation controls, while the **store**, **ok**, **cancel**, **last** and **now** buttons are replicated on the **Automation** screen.

The four coloured, backlit buttons are context-sensitive and illuminate only when they are available. Typically, three scenes in the cue list (**Automation** screen) will be highlighted to match the button colours (red, yellow or green) to show which scene each button will act upon.

The jogwheel quickly scrolls through the individual scenes in either direction. You can even go to the empty scenes towards the end of the cue list and then wrap to the beginning. Operation of the jogwheel does not affect scene selection.

The **next** LCD button displays information on the scene you have just scrolled to.

Additional function buttons on the **Automation** screen allow you to copy scenes and also to choose what is stored within each scene (store and recall scope buttons).



The eye icon  in the **Automation** screen (just under the **ADD MIDI** button) opens a **Show** window, which contains a list of filter options.

>> To navigate the scenes using the jogwheel

Rotate the jogwheel in a clockwise or anti-clockwise direction to scroll through the scenes one by one.

When using the jogwheel the **next** LCD button will illuminate yellow and will track the scene currently highlighted in yellow in the cue list. In this case, pressing this button will only have an effect if a non-empty scene is currently highlighted.



>> To recall a scene

Important:

When recalling a new scene, make sure monitor output levels are low, as the new scene's settings may produce higher audio output levels than the one it is replacing. Also, recalling a scene clears any unsaved adjustments made to the previous scene.

Do one of the following:

- Press **last** to change scene selection to the one currently highlighted in red in the cue list, which was the last selected scene.
- Press **now** to change scene selection to the one currently highlighted in yellow in the cue list.
- Press **next** (LCD button) to change scene selection to the one currently highlighted in green in the cue list, which is the scene immediately following the 'now' scene. However, if you have used the jogwheel the effect will be different.



>> To create a new scene using the current settings

- 1 Click **STORE SCENE**.
- 2 In the **Store Scene** window (shown right), type in the scene name.
- 3 In the **Notes** panel, type in any scene notes.
- 4 Do one of the following:

- Click “Insert before scene” to put the new scene in between the one currently highlighted in yellow and the scene immediately before it.
- Click “Store to empty scene” to put the new scene in the one currently highlighted in yellow, provided it is empty.
- Click “Store to next scene” to put the new scene in the next one, provided it is empty.
- Click “Overwrite scene” to overwrite the scene currently highlighted in yellow.

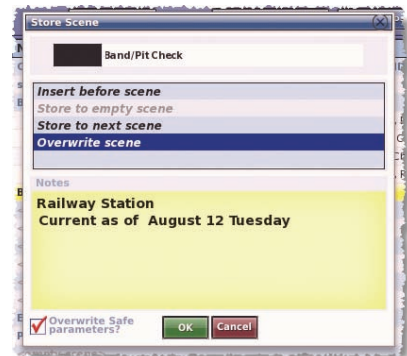

An **OK** button will appear at the bottom of the window, to the left of the **Cancel** button.

The options in the **Store Scene** window are context-sensitive, so some may be greyed-out to show that they are unavailable.

- 5 Click **OK**. This will store the scene, saving any changes you have made, and close the window. (Clicking **CANCEL** will close the window, ignoring any changes.)

Additional control — managing events

You can use the MIDI or GPIO functions of the control centre to control the parameters of an external device (outgoing), and conversely you can use an external device to control the control centre (incoming). Also, by using the unique 'internal' event option, you can trigger events from within the showfile itself. All this is done by creating events in scenes/point scenes.

You can have any number and types of events in any scene/point scene, and event parameters are set up and edited in an **Edit Event** window. Similarly to scenes/point scenes, you can skip events during rehearsals.

To aid event management, a menu opens (shown right) when you right-click a scene/point scene or event. The menu options allow you to create, edit and copy events. Click an option to select it.

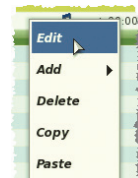

The following shows what some of the event symbols in the **Automation**

screen mean: = currently selected event; = MIDI event;

= GPIO event; = internal event; = incoming event; and

= outgoing event.

>> To create an event

Select the scene in which you want to create the event, and then do one of the following:

- Click the **ADD GPIO**, **ADD INTERNAL** or **ADD MIDI** button as necessary.
- From the 'right-click' menu, choose **Add ▶ Midi Event**, **Add ▶ Internal Event** or **Add ▶ GPIO Event** as necessary.

>> To edit an event

- 1 Open the **Edit Event** window by doing one of the following:
 - Right-click the event you want to edit and then choose **Edit** from the right-click menu.
 - Select the event you want to edit and then click **EDIT**.
- 2 In the **Edit Event** window, choose your options as necessary. For example, you can use a program change to trigger the event.
- 3 Click **CLOSE** to close the **Edit Event** window.

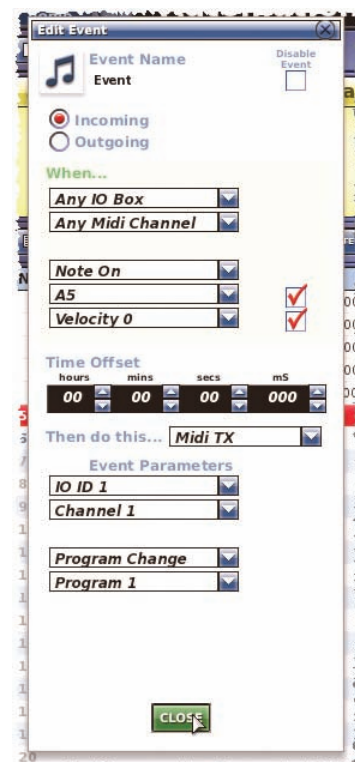

>> To copy and paste an event

- 1 Right-click the event you want to copy, and then choose **Copy** from the menu.
- 2 Select the scene in which you want to paste the copied event. Or, if the scene already contains an event(s), select the event after which you want to paste the copied event.
- 3 Right-click to open the menu, and then choose **Paste**.

Show editor

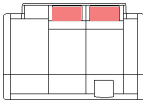

The **Show Editor** screen lets you very easily copy and paste settings through scenes.

The panel at the far left of the **Show Editor** screen shows the sources, such as channels, GEOs and effects, from which you can copy the settings. The **Sections** panel in the centre of the screen contains source sections that you can copy to the scene(s). At the far right of the screen is the **Scenelist** panel, which is a cue list of the current show. For details of the parameters per area, see Appendix P "Parameters Copied Through Scenes" on page 581.

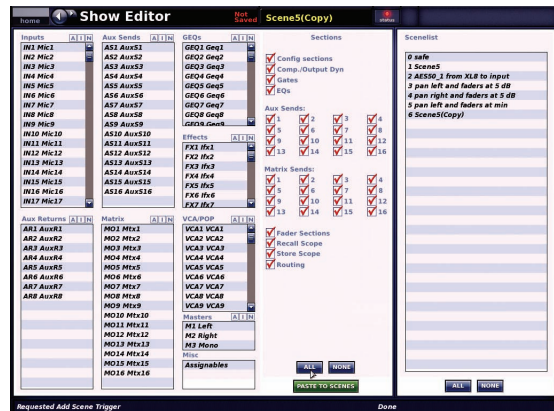

Note: The number of inputs and matrices shown in the **Show Editor** screen are dependent on the PRO Series type.

>> To open the Show Editor screen

Do one of the following:

- From the GUI menu, choose **home ▶ Automation ▶ Show Editor**.
- At the **Automation** screen, click **SHOW EDITOR**.

>> To copy and paste sections to a scene(s)

- 1 In the **Show Editor** screen, click the sources that contain the sections you want to copy to a scene(s). These are in the far left panel of the screen. You can choose any combination of inputs, aux returns, aux sends, matrices, GEOs, effects and masters.
- 2 In the **Sections** panel, click the boxes of the sections that you want to copy. Ticked options will be copied.
- 3 In the **Scenelist** panel, click the scene(s) in which you want to paste the sections. You can use the buttons at the bottom of the list to help you, as follows:
 - Click **ALL** to select all of the scenes in the list.
 - Click **NONE** to deselect all selected scenes.
- 4 Click **PASTE TO SCENES**.

Configuring the inputs and outputs

Similarly to the VCA/POP groups, you can change the name and colour of each of the inputs and outputs. This is done via the GUI at their respective sheet screens. For configuration details, see “Configuring VCA/POP groups” on page 105.

>> To open the Input/Output Sheet screen

Do one of the following:

- At the GUI, choose **home** ▶ **Input Channels** ▶ **Input Sheet** to open the **Input Sheet** screen, or choose **home** ▶ **Mix & Outputs** ▶ **Output Sheet** to open the **Output Sheet** screen.
- In the primary navigation zone, press the **inputs/outputs** screen access button to open the **Input Sheet** screen. To open the **Output Sheet** screen, press it again.

Using copy and paste

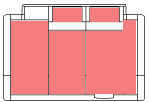

The **copy** and **paste** buttons (upper-right corner of GUI) let you copy the parameters of one/all of a single channel's processing area(s) — such as the EQ, compressor, gate etc. — and paste them to one/all of the channels of a similar type.



copy and **paste** buttons on the GUI. Right-clicking a **copy** or **paste** button will open its respective menu, which contains full copy/paste options.

>> To copy a processing area to a channel/all channels

- 1 If necessary, navigate the channel's processing area to the channel strip (see “To select a processing area” on page 68).
- 2 Click **copy**.
- 3 Do one of the following:
 - To copy the processing area to another channel, select the channel and then click **paste**. (As the copied parameters are still stored, you can paste to as many channels as you want.)
 - To copy the processing area to all other channels, right-click **paste** to open its menu and then choose **Paste To All**.

>> To copy all parameters to a channel/all channels

- 1 If necessary, select the channel from which you want to copy all of the processing areas.
- 2 Right-click **copy** to open its menu, and then choose **Copy All**.
- 3 Do one of the following:
 - To copy the parameters to another channel, select the desired channel and then click **paste**.
 - To copy the processing area to all other channels, right-click **paste** to open its menu and then choose **Paste To All**.

Copy and paste rules and restrictions

- You can only copy and paste similar functions. For example, you can't copy the input EQ from one channel to the output EQ of another, as they are different.
- You can only copy and paste across similar channel types. For example, you cannot copy from an aux and paste to a matrix.
- Copying and pasting across inputs is restricted to the input bays only.
- Channel names are not copied.
- Compressor and gate side chain listen cannot be copied.

For details of the channel parameters that are copied across, see Appendix N "Parameters Affected By Copy And Paste" on page 511.

User library (presets)

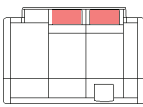

The control centre has a user library where you can store settings, such as for the EQ or the whole channel. For example, you may wish to store the EQ settings of a singer who may be called upon to perform during a future show. You can then easily recall these EQ settings to the appropriate channel, when required.



Store and load preset buttons on the GUI

The settings are stored as presets, which are saved in a library. The library files are managed via a **Preset Manager** screen on the GUI. Here, you can create new libraries, load existing libraries, save the current library or give it a new name. You can also delete presets from the library.

Before you can save/load a preset, you need to create a new preset library or open an existing one. To create a new one, open the **Preset Manager** screen (choose **home** ▶ **Preset Manager**) and click **New**. Then, after typing in the details in the **Enter new Library name window**, click **OK**.

>> To save a preset to the user library

- 1 Make sure that the settings you want to save are assigned to the channel strip, then click **store preset**. If the channel's overview is displayed, all of its settings will be saved in the preset. Otherwise, just the settings of the displayed processing area will be saved.
- 2 In the **Save Preset** window (shown right), type in your chosen preset name (**Preset Name**), your name (**Preset Author**) and any note (**Notes**) as necessary.
- 3 Click **OK**.

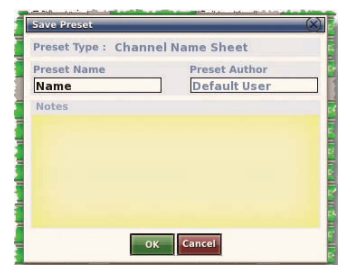

>> To load a preset

- 1 Make sure that the channel in which you want to load the settings of the preset is assigned to the channel strip, then click **load preset**.
- 2 In the **Load Preset** window, click the desired preset.
- 3 Click **OK**.

Surround panning

In addition to stereo and left-centre-right (LCR) panning, the control centre has three surround panning modes: quad; left, centre, right and surround (LCRS); and 5.1 surround.

To help you visualise the surround panning envelope, the masters processing area of the GUI channel strip has a spatial diagram (shown right) that updates in real time when you operate the panning controls.

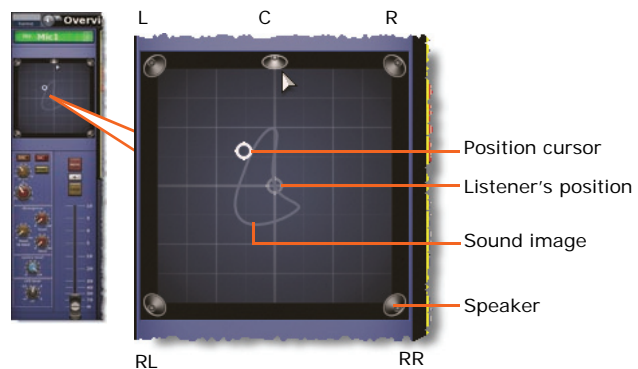

The surround panning modes are operated via a surround monitoring system, which uses matrix channels 1 to 6 as the surround bus channels. The channels are muted via six **MUTE** buttons in the master bay. Control centre monitor output connections are via the **surround, sub, centre** and **front** XLRs on the rear panel.

The 5.1 panning mode uses all six channels, while quad mode uses four (left and right on both the front and surround). Although the LCRS mode uses five channels (front left and right, centre and surround left and right), both surround channels are the same. (In an LCRS surround panning arrangement, you can have a single surround speaker positioned directly behind the listener.)

In surround mode, the **SIS** button routes the channel to the surround buses in much the same way that the **ST** button routes to the master buses.

Figure 18 "5.1 surround panning arrangement" on page 121 shows the location of the surround **MUTE** buttons and their matrix channel allocation, and shows the allocation of the surround **MUTE** buttons per loudspeaker and the recommended¹ 5.1 surround system configuration.

>> To select the surround panning mode

- 1 At a GUI screen, choose **home** ▶ **Preferences** ▶ **General** to open the **Preferences** screen.
- 2 In the **Surround Mode** section, select the desired surround mode.

1. Reference - ITU-R BS.775.1, 1994. *Multichannel stereophonic sound system with and without accompanying picture*. International Telecommunications Union.

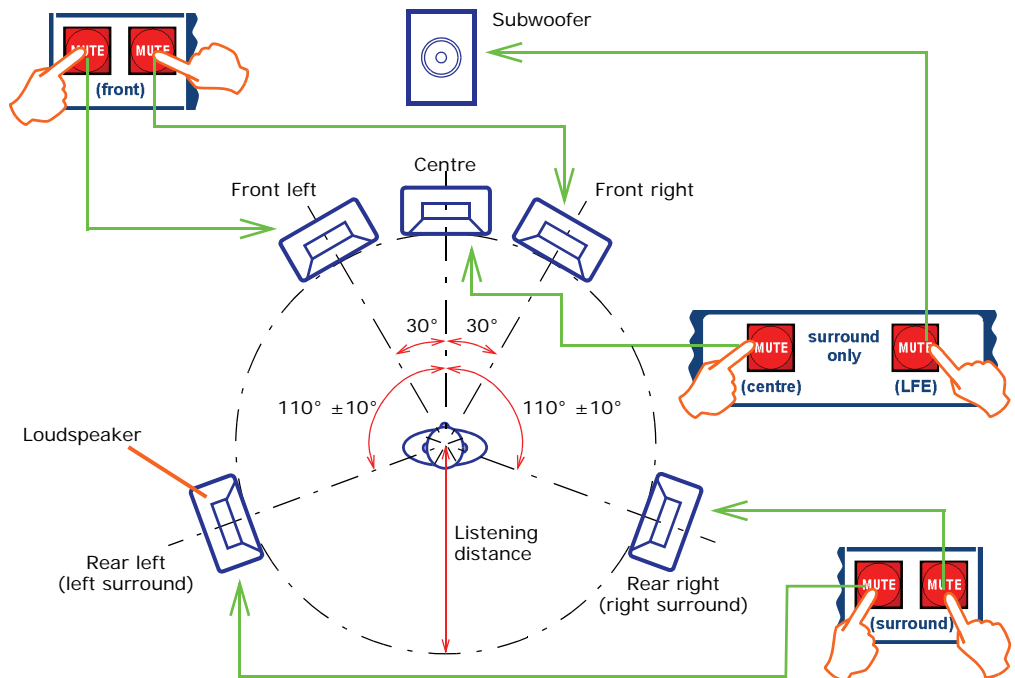
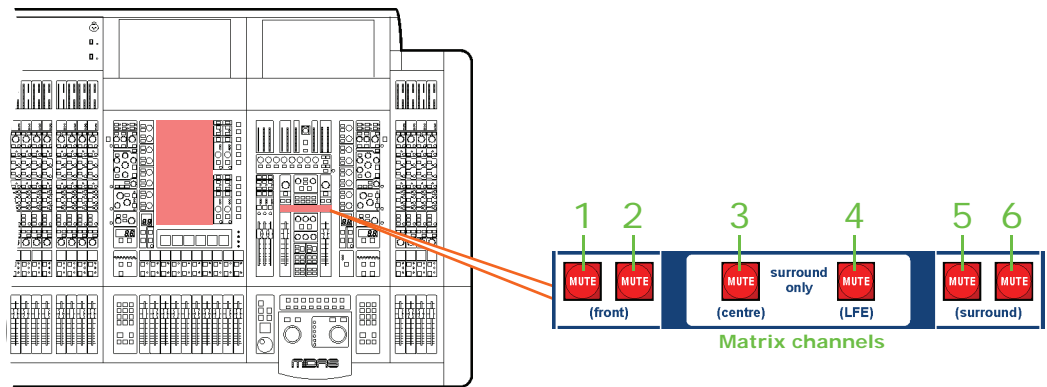

Figure 18: 5.1 surround panning arrangement

Two-man operation

The control centre can be operated by two people simultaneously. In this mode of operation the 4-channel input bay is designated as area B, and operates independently of the 12-channel input bay, which is always area A. (You can have the same channel selected simultaneously in both bays.)



This feature can also be used by a single operator if they require somewhere to store important channels. In this case, area B can be used in the same way a 'channel 25' would be used on an analogue console.

The following diagram shows the areas designated as A and B during two-man operation and also shows the location of the area B button. All other parts of the control surface are common to both areas.

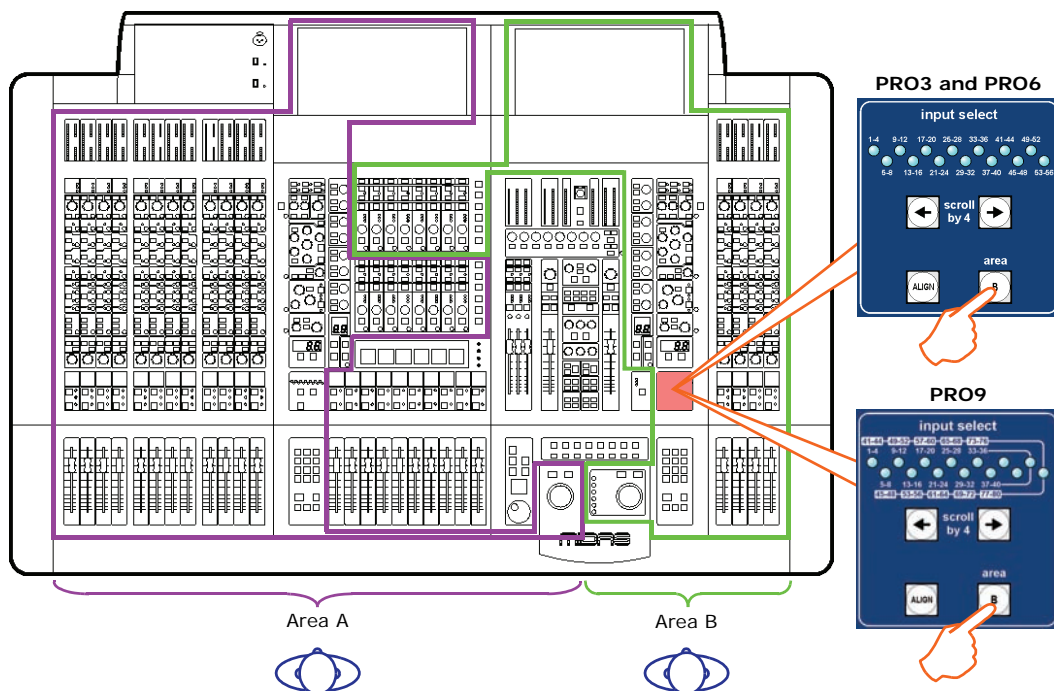

Figure 19: Two-man operation

VCA/POP groups can be pre-selected to populate area A or B, and a single group of inputs can have members in both areas of the control surface. An operator can then recall them to their own area to work on.

Note: When operating in area B, remember to select the B option, where appropriate, particularly in the monitor section. Also note that solo B (also for talkback) is totally independent of area B, which is used for navigation only.

>> To set up the control centre for two-man operation

In the **input select** section of the master bay, press **B** (see Figure 19 above).

Saving your show files to a USB memory stick



When you are satisfied that your show file is how you want it, we recommend that you save it to a removable storage device (USB memory stick). This provides a valuable back up should the show file stored in the internal memory of the control centre be lost, for example, due to inadvertent deletion.

You can also load show files onto the control centre from the same storage device.

>> To save (export) a show file to a USB memory stick

- 1 If necessary, close and save the show file you want to export; you can't export a show file that is open.
- 2 Insert the USB memory stick into the active USB socket, which is the one with the flashing **active** LED. For example, **USB key 2** (shown right).
- 3 Do one of the following:
 - At the GUI, choose **home ▶ Files**.
 - In the primary navigation zone, press the **automation/filing** screen access button twice.

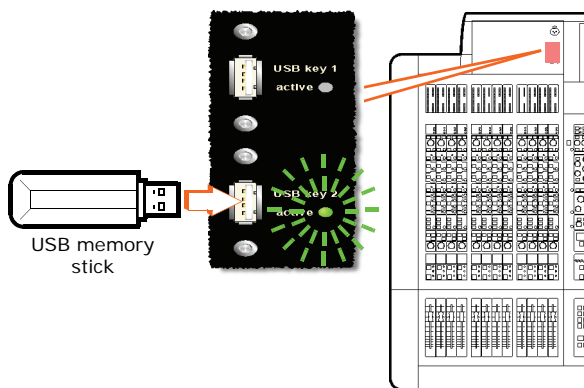

- 4 You may see an "Analysing..." message in the **Removable Storage** panel, which means that the Midas folder on the USB memory stick is being read. Wait for the message to clear. Then, in the **Control Surface** panel, click the show file you want to copy (shown right).
- 5 Click **EXPORT**.

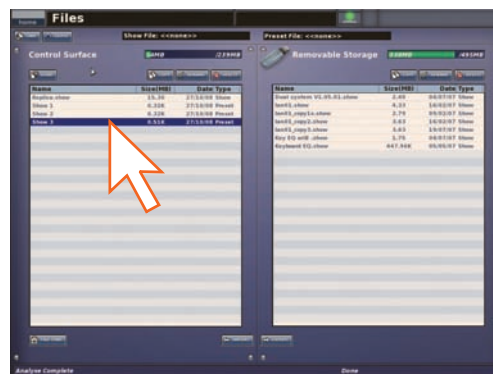

- 6 In the **Are You Sure you Want To Export?** message window, click **OK**. The file will start copying to the USB memory stick.
- 7 When your show file appears in the **Removable Storage** panel, it has finished copying to the USB memory stick. Remove the USB memory stick.

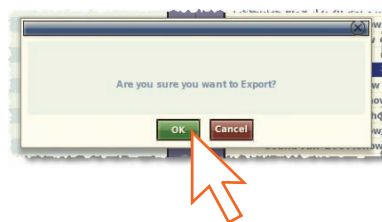

>> To load (import) a show file from a USB memory stick

The procedure is similar to the export procedure, as detailed in "To save (export) a show file to a USB memory stick" on page 123, but select the file to be imported to the control centre from the **Removable Storage** panel and then click **IMPORT**.

External AES50 synchronisation

If you want to connect AES50 audio between two Midas digital consoles the slave console must be set to external AES50 synchronisation, irrespective of the synchronisation source of the master console.

<i>Console 1 sync setting</i>	<i>Console 2 sync setting</i>			<i>External AES50 from console 1</i>
	<i>Master</i>	<i>Word clock</i>	<i>AES3</i>	
Master	Not valid	Not valid	Not valid	Valid connection
Word clock	Not valid	Not valid	Not valid	Valid connection
AES3	Not valid	Not valid	Not valid	Valid connection
External AES50 from console 2	Valid connection	Valid connection	Valid connection	Not valid

A valid connection can be a tie line between the stage routers or the secondary port (Bx/By) of a mic splitter that has its primary port (Ax/Ay) connected to the master console.

Security (locking mode)

If you need to leave the control centre unattended, but you want to preserve its current state of operation, you can lock it via the GUI menu. This will prevent unauthorised adjustment of its settings. When locked the GUI displays the 'splash' screens (shown during the start up sequence) and none of the controls on the control surface will function; the control centre will be totally locked out.

>> To lock the control centre

At the GUI, choose **home ▶ Lock**.

>> To unlock the control centre

At the GUI, click **UNLOCK**. This button is in the lower-left corner of both GUI screens. For security, this button has been designed to blend in with the background to disguise it. When unlocked, the control centre will revert to the state it was in the last time it was locked.

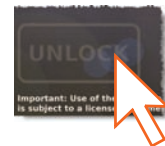

Advanced Operation And Features

Chapter 10: Stereo Linking

By default, all of the channels of the PRO Series Control Centre are mono (unpaired). However, adjacent channels can be linked together to form a stereo pair, which is known as “stereo linking” (or “channel pairing”).

You can choose which controls/parameters are linked across the channel pairs. The default settings specific to each channel type can be altered globally via the **Stereo Linking Default Settings** window (see “To set the global default stereo linking options” on page 128). However, these can be overridden from the **Stereo Linking Options** window on per pair basis (see Figure “Linking the master channels” on page 129). For details of the stereo linking control areas available for each channel, see Appendix O “Parameters Affected By Stereo Linking” on page 539.

When paired, the controls for each signal path act simultaneously on both the left and right signal paths. Individual trims, for example, adjusting the mic amp gains to balance stereo mix inputs, can be applied to the left and right audio paths individually. The channels are not truly mono at this time, and any settings necessary to preserve the audio prior to trimming, such as dynamics side chain linking, are maintained.

Note: *The pan control is never linked.*

When linking previously unlinked channels, some normalisation of the prospective left and right control settings, which may be quite different, is required. The PRO Series does this by automatically copying the control settings of the left channel (with the exception of the pan controls) to the right channel. The pan controls, depending on whether they are in the left or right audio paths, should be manually set to hard left or hard right, respectively.

>> To link two channels

- 1** Assign the configuration processing area of the desired input channel (left channel of pair you want) to the GUI channel strip by doing one of the following:
 - For an input channel, press the quick access button in the **gain trim** section of its fast strip. If necessary, navigate the channels to the control surface.
 - For an output channel, press the quick access button in its fast strip. If necessary, navigate the channels to the control surface.
- 2** At the GUI, click the **LINK** button. This is located towards the top of the GUI channel strip in the configuration processing area.
- 3** In the left channel of the linked pair, set the **pan** control knob fully anti-clockwise.
- 4** In the right channel of the linked pair, set the **pan** control knob fully clockwise.

Changing the linking options

You can choose which control options will be linked across the channel pair, either globally or on a per pair basis. The per pair settings always override the global ones. For details of the linked parameters for each section, see Appendix O "Parameters Affected By Stereo Linking" on page 539.

>> To set the global default stereo linking options

- 1 At the GUI, choose **home ▶ Preferences ▶ Linking**. This will open the **Stereo Linking Default Settings** window (shown right), which is divided into channel types.
- 2 In a channel section, select the desired default stereo linking options and then click the **Change Existing** button directly underneath.



Repeat as necessary for any other channels.

Selected control options will be linked across the channel pair of the appropriate type. Unselected controls remain independent on each channel.

>> To set the stereo linking options for a channel pair

- 1 Make sure that one of the paired channels is selected and its configuration processing area is assigned to the GUI channel strip. Then open the **Stereo Linking Options** by clicking the **st. linking options** button in the GUI channel strip.
- 2 Select the controls that you want linked across the channel pair. A typical **Stereo Linking Options** window is shown right. The active options will be channel dependent.
- 3 Click **CLOSE**.



Linking the master channels

You can link the left, right and centre master channels in a two-way link (left and right) or even a three-way link (left, centre and right), both of which use the linking parameters set for the left master channel.

>> To link the left and right master channels

- 1** In the left master channel (control surface), press its quick access button (just above the fader) to select it.
- 2** Set the stereo linking options for the left master channel, see "To set the stereo linking options for a channel pair" on page 128. These settings will apply to the linked stereo pair.
- 3** Click **LNK**.

>> To create a three-way master channel link

The centre channel can only be linked to a left/right master pair. If necessary, link the left/right master channels (as detailed above). Then, click **LNK** in the configuration processing area of the mono master channel.

Chapter 11: Panning

The PRO Series Control Centre has two main types of panning mode, default and surround. The default mode comprises stereo and LCR panning formats, and only uses the channels for the front loudspeakers, while the surround mode includes channels for the rear surround loudspeakers.

The following table shows the panning formats available on the PRO Series.

Table 7: Panning formats

<i>Panning mode</i>	<i>No. of channels</i>	<i>Format</i>	<i>Channel types</i>
Default	2	Stereo	L, R
	3	LCR (SIS™)	L, C, R
Surround	4	Quad	L, R, Lr, Rr
	4	LCRS	L, C, R, S
	5	LCRS	L, C, R, Ls, Rs
	6	5.1	L, C, R, Ls, Rs, LFE

Key: L = left; R = right; C = centre; Lr = left rear; Rr = right rear; Ls = left surround; Rs = right surround; S = surround; LFE = low frequency effects (usually handled by a subwoofer)

Stereo panning

The control surface controls for stereo panning are located in the **masters** section of each input fast strip and each channel strip.

The pan control associated with the **masters** section may be switched for either conventional or spatial imaging system (SIS™) stereo operation by using the **ST** or **SIS** switches, respectively.

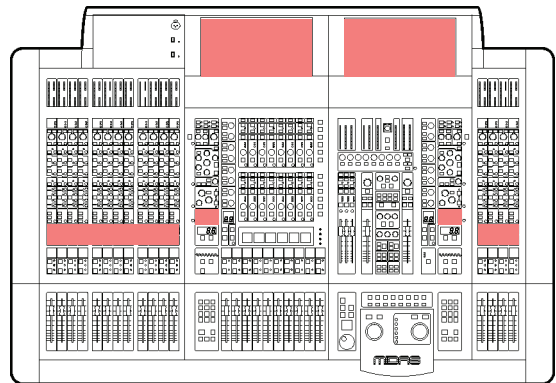

SIS™ (LCR) mode

The Midas SIS™, which is used for left-centre-right (LCR) loudspeaker systems, configures the channel for LCR mixing. The **SIS** switch activates the spatial imaging system, which uses the **SIS image** control knob to modify pan control knob operation so as to place the channel within a three-speaker system.

With the **SIS image** control knob set fully clockwise or anti-clockwise the image is full LCR or stereo, respectively. Control knob positions in between generate a composite blend of stereo or LCR panning systems, so that optimum degrees of centre image focus and speaker power can be obtained. This is illustrated in the following subsections, which shows the **masters** section in the channel strip.

Constant power is maintained at all times so that the *image* can be adjusted during the show without a perceived change in level.

SIS image control knob fully clockwise (LCR)

With the **SIS image** control knob fully clockwise the **pan** control knob operates in full LCR mode. A centre-panned signal, that is, with the **pan** control knob set to the **c** position, routes to centre speaker only; there is no signal in the left and right speakers.

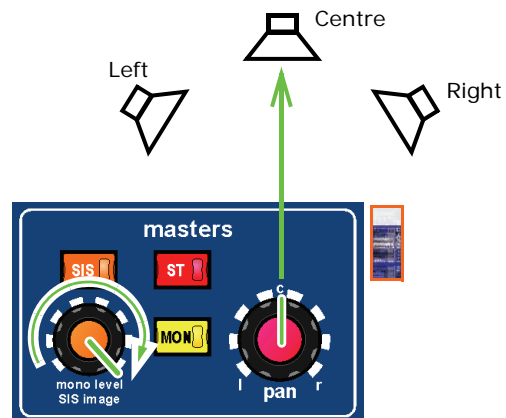

SIS image control knob fully anti-clockwise (stereo)

With the **SIS image** control knob fully anti-clockwise, the **pan** control knob operates as stereo. A centre-panned signal routes to the left and right speakers at equal power.

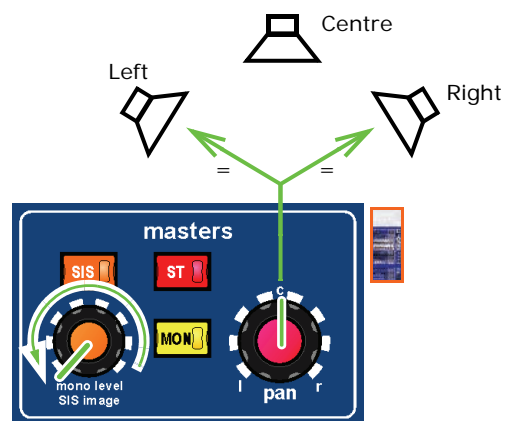

SIS image control knob centred (equal power)

With both the **SIS image** and **pan** control knobs centred, the signal is routed to all three speakers with equal power.

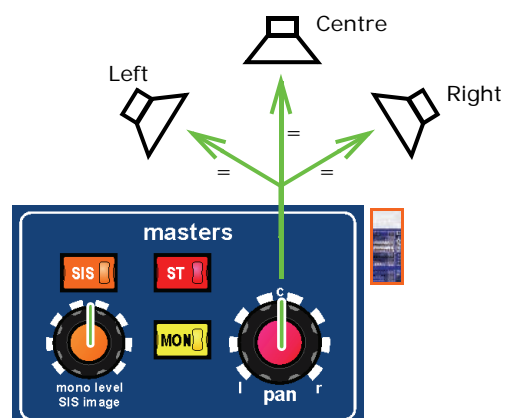

Surround panning

There are three surround panning modes: quad, LCRS and 5.1. These are assigned on a channel wide basis, that is, if the control centre is in 5.1 all channels are in 5.1. This allows control and distribution of the three surround formats without re-patching. The same applies to monitoring.

For more information on surround panning, see “Surround panning” on page 120. For information on the set-up for each mode, see Figure 31 “Connections for a quad surround system (with recommended speaker set-up)” on page 269, Figure 32 “Connections for an LCRS surround system (with recommended speaker set-up)” on page 270 and Figure 33 “Connections for a 5.1 surround system (with recommended speaker set-up)” on page 271.

Table 8: Surround panning bus routing

<i>Buses</i>	<i>Matrix 1</i>	<i>Matrix 2</i>	<i>Matrix 3</i>	<i>Matrix 4</i>	<i>Matrix 5</i>	<i>Matrix 6</i>
Quad	Left	Right	None	None	LS	RS
Surround	Left	Right	Centre	None	S (same as Matrix 6)	S (same as Matrix 5)
5.1 surround	Left	Right	Centre	Sub	LS	RS
Monitor	A Left	A Right	Centre	Sub	B Left	B Right

Simultaneous generation of stereo masters, mono masters, stereo auxes, mono auxes, stereo matrices and mono matrices (excluding buses 1 to 6) is possible in all surround modes. However, SIS™ panning to masters is not possible.

Operation of the monitor system in surround or stereo is a mode selection that can be made independently or in conjunction with the surround bussing on the control centre, that is, you can still monitor and solo in stereo, even if you are producing a 5.1 mix.



Surround panning connectors on rear panel of PRO Series Control Centre

Left/right panning control utilises the normal stereo pan pots. Front/back panning is made possible by taking over the **mono level/SIS image** control knob on the control surface (**masters** section of each channel strip).

Trackball panning and external devices that operate the GUI pointer can also operate the surround panning on a selected channel.

Bus routing to the six surround matrices remains unchanged, that is, it will be possible to route and place an image anywhere within the surround stem from inputs, auxes, aux/group buses and master buses.

Input of pre-recorded surround material is possible from the direct inputs to the six matrix buses (with no panning available).

No fold down facilities are implemented for externally inputted surround material. However, a stereo mix can be monitored by switching the monitor section back to operate in stereo mode sourced from the stereo masters rather than the six surround matrix modules. This requires an identical stereo mix to be built at the same time the surround mix is generated, which is normal practice.

When monitoring in surround formats the monitor centre and sub speakers are muted via the assignable stereo output mutes, while the front and surround speakers are muted via the A and B monitor mutes.

In normal stereo mode, two assignable outputs — typically the main stereo left and right — can be patched to the centre and sub XLRs to free up eight bay modules I/O.

>> To select a surround panning mode

- 1 At the GUI, choose **home** ▶ **Preferences** ▶ **General**.
- 2 Under the **Surround Mode** heading, click your chosen surround mode. For example, "5.1". The currently selected mode contains a red circle.

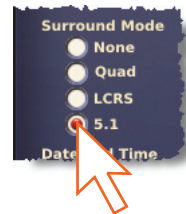

About the controls in surround mode

When the PRO Series is configured to operate in one of the surround panning modes, the spatial diagram that appears in the GUI channel strip gives you a visual representation of the sound image in relation to the speakers (as viewed from above).

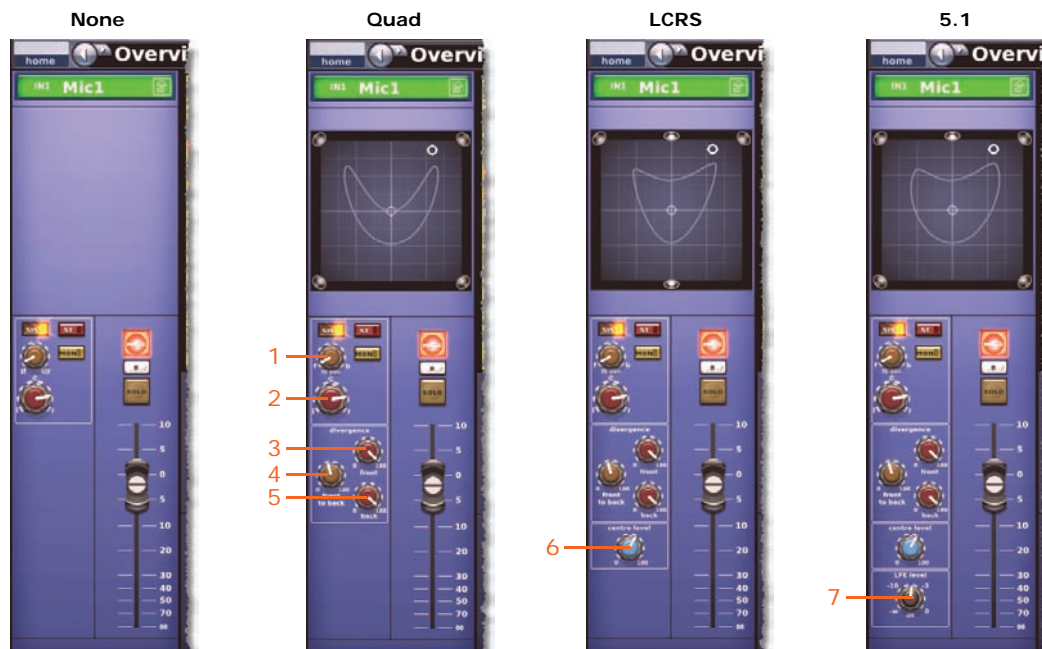

An example of each surround panning mode, as displayed in the GUI channel strip. Although the example shows input channels, this is typically the same for the outputs.

<i>Item</i>	<i>Description</i>
1	fb pan control knob, moves position cursor in spatial diagram up/down.
2	Left-centre-right control knob, moves position cursor in spatial diagram left/right.
3	front control knob, adjusts the divergence of the front speakers.
4	front to back control knob, adjusts the divergence of the front and rear speakers.
5	back control knob, adjusts the divergence of the rear speakers.
6	centre level control knob, adjusts the divergence of the centre speaker.
7	LFE level control knob, adjusts the signal level of the LFE (usually a subwoofer).



Although the position cursor changes automatically according to the adjustment of the surround panning controls, you can also adjust it on the GUI using drag.

The following table shows the fader parameters with **None** selected as on/off in the **Surround Mode** section of the **Preferences** screen (see “Setting the configuration preferences” on page 249).

Table 9: Fader parameters with surround panning on/off

<i>Parameter</i>	<i>None mode off</i>	<i>None mode on</i>	<i>Notes</i>
Level (fb pan)	Yes	Yes	If left or right channel has SIS on, level is image (below). In other surround modes, it is front/back pan (below).
Image (fb pan)	Yes	Yes	See above
Pan	Yes	Yes	See above
Divergence (front to back)	Yes	N/A	N/A
Divergence (front)	Yes	N/A	N/A
Divergence (back)	Yes	N/A	N/A
Centre level	Yes	N/A	N/A
LFE level	Yes	N/A	N/A

Speaker placement

As the placement of loudspeakers is very important for accurate mix monitoring — especially for multi-channel mixing for surround sound — you should consider speaker positioning, angling and level calibration when setting up your monitor system. If necessary, consult the manufacturer of your monitor system for their recommended surround formats.

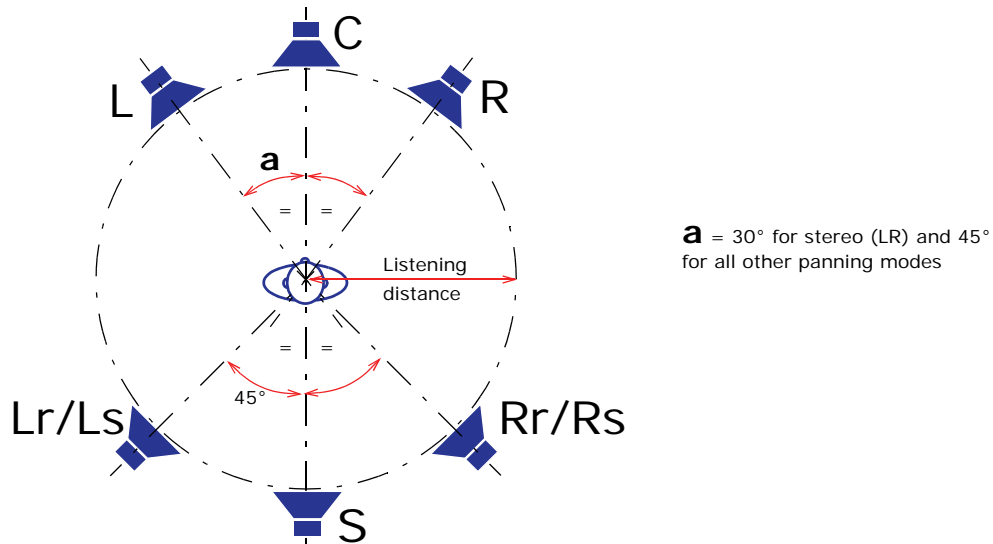

Typical examples of loudspeaker placements for each panning mode (see Table 7 “Panning formats” on page 131). Please note that these are only an approximation and should only be used as a guide.

Note: *LCRS has a mono surround channel, which is often fed to two rear ‘satellite’ speakers.*

Chapter 12: Soloing

With solo you can isolate the sound from a single channel, which is helpful in fault finding and when equalising a signal. Pressing a solo button cuts all signals routed to the monitor output, except the one local to the solo button (mix minus is bus mode of the aux outputs, and does not affect the solo buses — if you solo an aux in mix minus mode, you still only solo that channel). So, you can monitor a signal at a level proportional to its level in the mix, in the same stereo position in the mix and with the same reverberation as in the mix.

The PRO Series Control Centre has two independent solo systems, solo A and solo B. Both have monitor and headphone outputs, and both can be used to PFL or AFL signals from the same sources throughout the control centre. This flexible solo bus configuration makes soloing of three-way monitor mixes — in-ears going to solo A and wedge going to solo B — possible and also greatly enhances the usefulness of the control centre for dual (two-person) operation (independent soloing).

Note: Solo A and B are not to be confused with area A and B (as in dual operation) and monitor A and B.

Using solo A/B

With solo A/B on, solo goes to the selected solo bus with the following conditions:

- If the solo button is pressed only for a short time, the soloing to the selected solo bus remains active when the button is released. If the solo button is held down, the soloing to the selected solo bus is cancelled when the button is released.
- Pre-fader audio is sent to the selected solo bus if the associated PFL control for that bus is active. Post-fader audio is sent to the selected solo bus if the associated PFL control is inactive.
- Unless multiple solo activations to the same solo bus are concurrent, the solo activation that occurred last — while the respective solo add mode (A or B) is inactive — cancels all earlier solos to the same bus before it activates.
- Solos can also be operated from a VCA master when the channel to which they belong is a member of that VCA. This is in addition to the local operation.
- Pressing the solo clear button associated with the solo bus (A or B) they are sending to will clear active solos.
- A solo hierarchy exists for each of the solo buses in the control centre (see “Solo hierarchy” on page 139). Activating a solo with a higher precedence in the hierarchy deactivates all solos with less precedence and inhibits them from being operated. As soon as the higher precedence solos are cleared, the stages of the inhibited solos are restored and they resume normal operation.

Some modifications to this hierarchy are possible. For example, mix buses can be used as sub-mixes (hierarchy is as described) or outputs (having same precedence as master outputs).

- Pressing ADD (solo A/B) off cancels all solos.
- Soloing inputs and outputs (with solo add switched on):
 - With any inputs active, you can't solo outputs.
 - With any outputs active, pressing an input solo overrides (cancels) the output solo. Then, if you cancel the input solo(s), the output solo(s) returns.

The effects of using the solo A and B buttons in combination are shown in the following table.

<i>Solo A</i>	<i>Solo B</i>	<i>Effect</i>
Off	Off	Solo goes to the A bus, but there is no solo in operation.
On	Off	Solo goes to the solo A bus.
Off	On	Solo goes to the solo B bus.
On	On	Solo goes to the solo A bus.

The effects of using the solo destination controls are shown in the following table.

Table 10: Solo A/B destination controls

<i>Control</i>	<i>Description</i>
PFL direct input	Direct inject to solo A from linked control centre, active only while solo A is PFL.
AFL direct input	Direct inject to solo A from linked control centre, active only while solo A is AFL.
PFL direct output	Mono summed direct output from solo A for linking to another console.
AFL direct output	Stereo direct output from solo A for linking to another console.
Solo add: • On (additive solos) • Off (self-cancelling solos)	Disables self-cancelling solo A/B solos. (When self-cancelling solos are selected, that is, with solo add mode off, the solo being cancelled should be deactivated before activating a new solo.)
Solo clear: • On (some solo A solos) • Off (no solo A solos)	Single button clearing of currently active solo A/B solos.
Solo PFL: • PFL (solo pre-fader) • AFL (solo after-fader)	Switch all current and future solo A/B activations to send the solo A/B bus pre-fader.
Solo in place (SIP): • On (SIP active) • Off (SIP inactive)	When active, SIP mutes all channels except the one being soloed. However, the audio of the soloed channels is still placed on the monitor outputs. For more information on SIP, see "Solo in place (SIP)" on page 139.

Solo hierarchy

The solo system add-mode hierarchy works as follows:

- The highest level of solos will be the inputs and returns. When active, these will override and inhibit the remaining solo sources (auxes, matrices and masters).
- Within the constraints of the two-level solo hierarchy, only one source can be active on any channel at any instant:
 - **Input channels:** Input channel <--> Aux AFL <--> Direct out <--> Side chain listen
 - **Return channels:** Return channel <--> Direct in
 - **Aux buses:** Aux bus <--> Direct in <--> Side chain listen
 - **Matrix outputs:** Matrix bus <--> Direct in <--> Side chain listen
 - **Master outputs:** Master bus <--> Direct in <--> Side chain listen

An additional constraint is placed on the side chain listen. This is due to the nature of the DSP, where only one side chain listen can be active on the control centre at any time, regardless of whatever else is active in the same solo hierarchy level.

- If an input channel solo is active via a VCA master solo, soloing the input temporarily overrides the VCA master solo. However, soloing a direct input or AFL solo on the same channel or a side chain solo on any channel, cancels both the input solo on that channel and any VCA master solos to which the input channel is assigned.

Solo in place (SIP)

By using solo in place (SIP), you can cut all channels from the main mix (except soloed ones) by pressing a solo button. SIP lets you check the contribution from soloed channels at the actual levels they occur in the mix, that is, taking into account the main fader setting. If solo buttons cut the main output (main mix) they must only be used in rehearsals. Sometimes, SIP selection buttons are disabled during recording (solo safe) or revert to AFL (only affects monitor outputs). See "solo system section" on page 149.

To prevent accidental SIP activation, the SIP button has a hinged clear plastic cover that has to be lifted up before you can operate it.

For SIP purposes, master outputs can be the main master bus or, if configured, a multi-channel output mix.

To be eligible for SIP muting, channels must be input channels and set up to solo to the solo A bus; channels with any other combination cannot be subjected to SIP muting. Channels eligible for SIP muting that are currently or subsequently muted by a means other than SIP (that is, local button press, auto-mute or scene recall) remain muted, regardless of the SIP status. On removal of the overriding mute, the mute is restored according to the current SIP status, see Chapter 13 "Muting" on page 141.

Chapter 13: Muting

You can interrupt (mute) the output signal of a channel. This is generally used for backstage mics, guitar switch over etc. Channel mutes can be activated by any of the following, which (except the VCAs) mute the channel outputs and update the channel mute status indicator:

- Local **MUTE** button press.
- Auto-mutes (mute groups/control groups) — see “Auto-mute (mute) groups” on page 180.
- VCAs — see “VCA and POP groups” on page 177.
- Scene recall (automation) — see Chapter 20 “Scenes And Shows (Automation)” on page 197.
- SIP — see “Solo in place (SIP)” on page 139.

To see which outputs are affected by channel muting, refer to Appendix B “Functional Block Diagrams”.

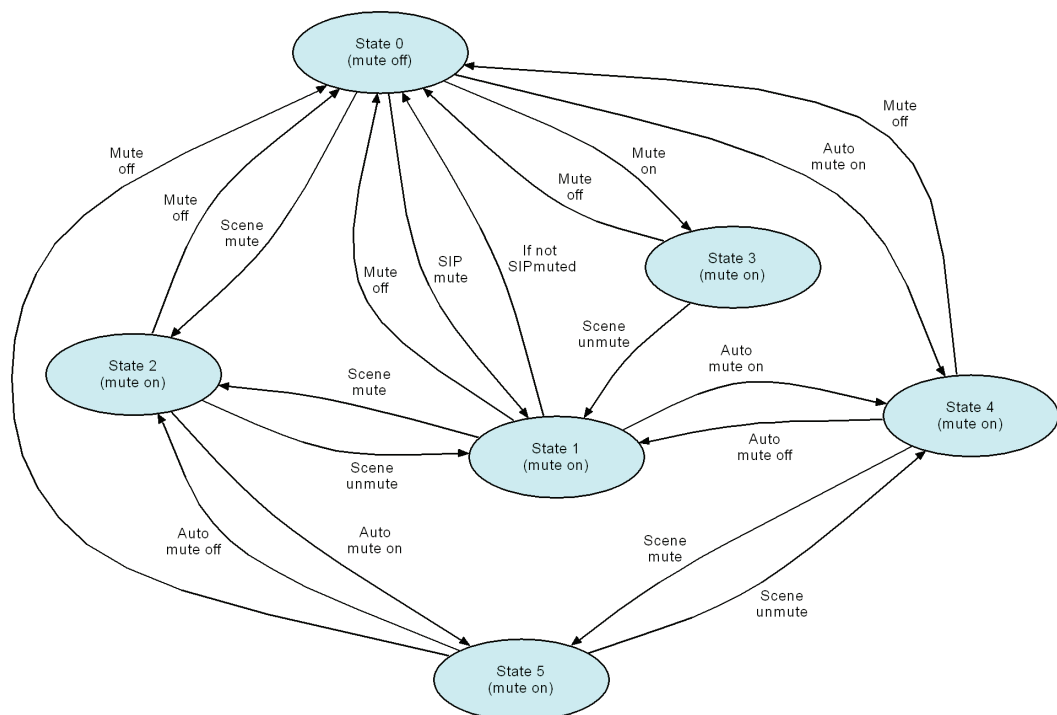

*Control methods, interactions and corresponding states of channel mute. In the diagram, all of the transitions between states, with the exception of State 1 to State 0 “If not SIP muted”, are events. The “If not SIP muted” transition is not an event, it happens as soon as the indicated test condition (“If not SIP muted”) is true. Also, “Mute on” and “Mute off” refer to mute activations and deactivations using the local **MUTE** button press method; SIP mutes only apply to input channels (the “If not SIP muted” exit condition from State 1 is always true for other channel types). An “Auto mute on” and “Auto mute off” are achievable in several different ways.*

Chapter 14: Monitors And Communications

This chapter describes the monitoring and communications functions of the PRO Series.

Monitors (A and B)

To match the two-bus solo system there are two monitor outputs, A and B, which control their respective output levels. These are controlled from the monitor section on the master bay (see Figure 20 “Monitor A and B strips” on page 144). Each monitor output has:

- The ability to monitor mono and stereo outputs, and an external input.
- An external talkback input.
- A local monitor output.
- A headphone output.
- Delay compensation.
- Control of the solo buses.

Although the capabilities of both monitors are the same, monitor A is the primary output. They both have a fader control, and there are six balanced XLR outputs on the rear panel (see “Monitor and assignable outputs/surround section” on page 268).

The monitor output controls *do not* have support from the screens and *are not affected by automation*.

The analogue section of monitor has six balanced XLR outputs (see “Monitor and assignable outputs/surround section” on page 268). These feed the six speaker XLRs and two headphone sets. Monitor inputs are fed from the router/line I/O module that contains digital solo source signals etc. converted to analogue, as selected on the control surface.

Only the meters have GUI support. The **monitor a** and **monitor b** meters monitor the peak signal levels of stereo left and right for both monitor paths. The metering capabilities of both monitors is the same.

>> To switch control of headphones to fader

Press **C/O**.

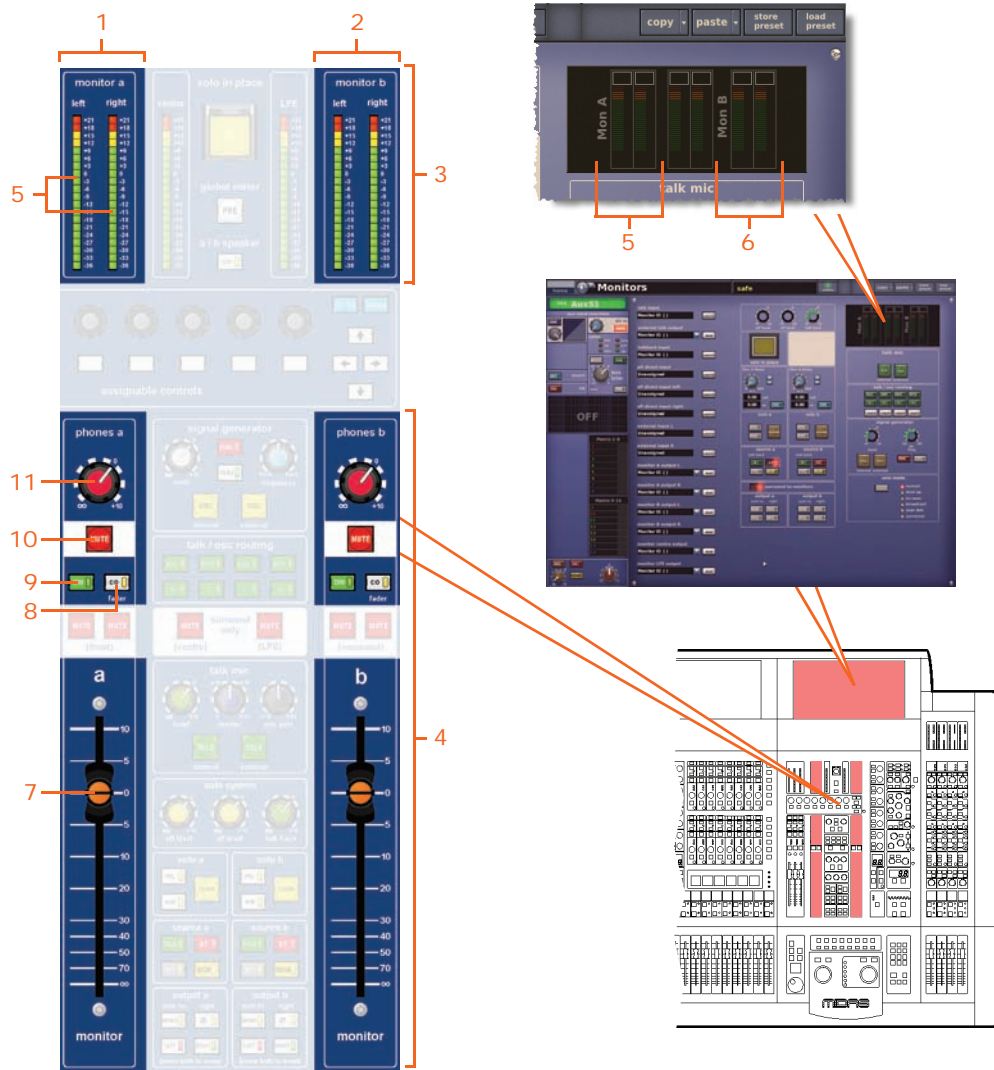

Figure 20: Monitor A and B strips

Item	Element	Description
1	Monitor strip	Monitor a strip.
2	Monitor strip	Monitor b strip.
3	Meters	monitor a and monitor b output panel meters.
4	Output panels	monitor a and monitor b output panels.
5	Meters	left and right meters for monitor a .
6	Meters	left and right meters for monitor b .
7	Fader	Non-automated fader for control of monitor A speaker level from -∞ to +10.
8	C/O switch	fader switch that switches control of output on headphones to fader to allow fader control of headphones.
9	DIM button	Dims monitor signal output level by 20dB on monitor speakers.

<i>Item</i>	<i>Element</i>	<i>Description</i>
10	MUTE button	This is a headphones mute button that mutes the headphone jack.
11	Control knob	Adjusts headphones level, in the range infinity (∞) to +10dB.

Delay (GUI only)

You can delay each monitor output signal (A and B) individually by up to 500 milliseconds (ms). This is done via the two delay sections in the **Monitors** screen. This function does not have support on the control surface.



Monitor A and B delay sections on the GUI

<i>Item</i>	<i>Element</i>	<i>Description</i>
1	Control knob	Adjusts the monitor output signal delay in the range 0ms to 500ms.
2	Up/down spin buttons	Provide finer adjustment of the monitor output signal delay.
3	ON switch	Switches the delay on/off.
4	Two delay value fields	Show the current delay value in milliseconds (ms) and metres (m).

Solo system

solo a and **solo b** system sections allow solo signals to be selected independently for each monitor system (A and B). These can be selected as AFL (**PFL** extinguished), PFL (**PFL** illuminated), additive (**ADD** enabled) or interlock cancelling.

The monitor outputs can be configured for different uses:

- normal
- dual operation
- LCR monitor
- broadcast
- user defined

Each of these modes changes the interleaving logic between differing areas of the monitor output. A mode select button scrolls through the possible options.

Additionally, there is a **solo in place** switch for activating the SIP function.

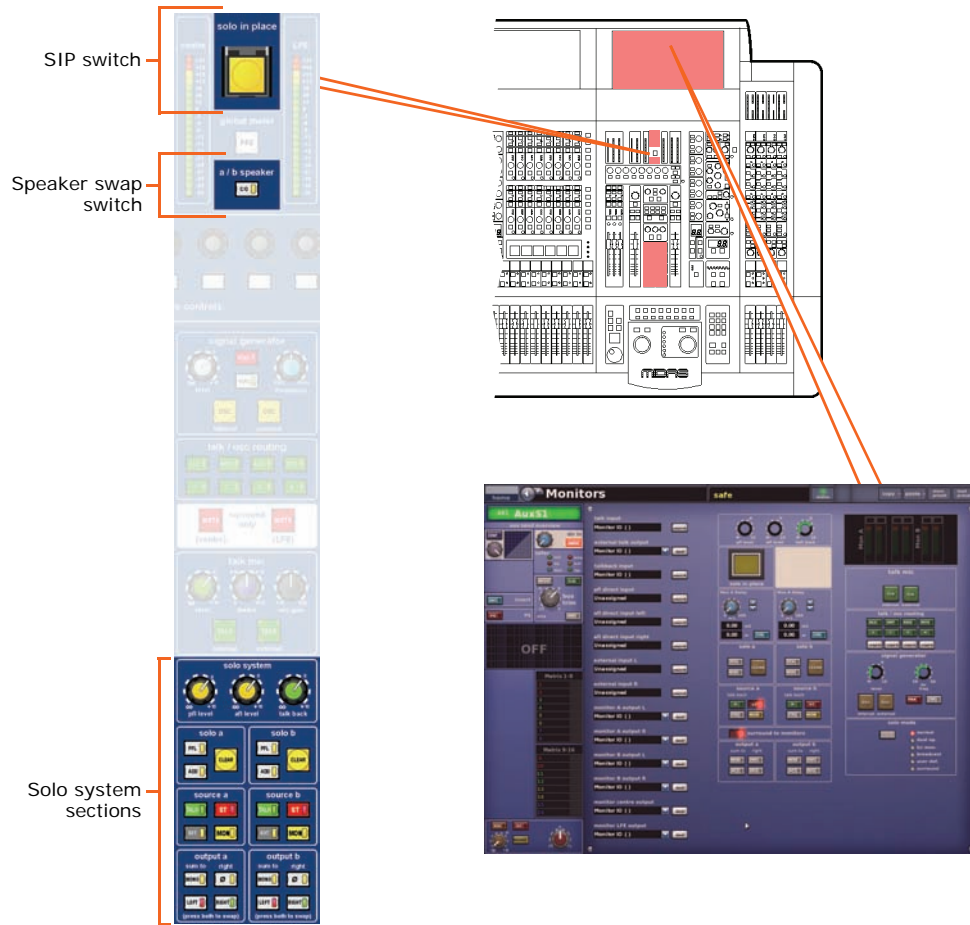

Solo system controls on the control surface and GUI

solo in place switch

The **solo in place** (SIP) switch puts the control centre in SIP mode. In this mode, pressing a **SOLO** button in an input fast strip activates a mute of all other channels by temporarily overriding the primary source selection, assuming it is set to the appropriate monitor (A or B); talk back remains unaffected.

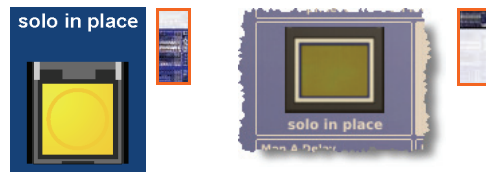

When SIP is switched on, all unsoloed inputs are muted, except the auto-mutes. With SIP in operation, pressing a **SOLO** button in a VCA section (for a group) solos all group members, while muting non-group members. When SIP is switched off, any solos are kept active but the mutes are removed (except the ones with auto selected, which are left alone).

As this is an important function that may have detrimental consequences, the button on the control surface is protected by a plastic cover to prevent it being inadvertently switched on/off.

You can protect a channel from this function by switching on its mute safe (see “Safes” on page 285).

>> To activate SIP

- 1 Do one of the following:
 - On the control surface, lift up the cover of the **solo in place** button and then press the button.
 - At the GUI, choose **home ▶ Monitors**. Then click **solo in place**.
- 2 In the “Activate SIP ?” message window, click **OK**.

>> To deactivate SIP

Press/click the **solo in place** button (control surface or GUI).

C/O switch

The **C/O (a/b speaker)** switch (control surface only) swaps speakers A with speakers B. The button’s LED illuminates when the B set of speakers are on.



Monitor output (a and b) sections

The monitor output sections — **output a** and **output b** — have common controls for the monitor A and B sections. The monitor’s output level is controlled by a non-automated fader, a **DIM** switch and left and right mutes (see Figure 20 “Monitor A and B strips” on page 144).

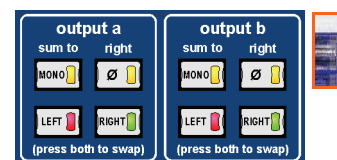

The buttons in each output section have an integral LED for on/off indication, and have the following functions:

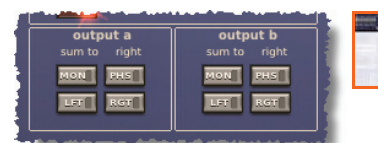

- **MONO/[MON]** switch, sums left and right signals, but with a $\pm 3\text{dB}$ loss. With 0dB on monitor A left and nothing on monitor A right, pressing **MONO** gives -3dB on both monitor A left and monitor A right. However, with 0dB on both monitor A left *and* monitor A right, pressing **MONO** gives +3dB on them both.
- **∅/[PHS]** phase reverse switch, reverses the phase of the right monitor signals.
- **LEFT/[LFT]** and **RIGHT/[RGT]** switches, route left and right monitor signals, respectively, to both left and right monitor speaker outputs. These switches can be used in combination, as shown in Table 11 below.

Table 11: Monitor signal routing

LEFT button	RIGHT button	Monitor signal routing
Off	Off	Left and right monitor signals are routed normally, that is, left monitor signal is routed to the left monitor speaker output, and the right one is routed to the right monitor speaker output.
On	Off	Left monitor signal is routed to both of the monitor speaker outputs.
Off	On	Right monitor signal is routed to both of the monitor speaker outputs.
On	On	Left and right monitor signal routing is swapped over, that is, left monitor signal is routed to the right monitor speaker output, and the right one is routed to the left monitor speaker output.

source (a and b) sections

The **source a** and **source b** sections contain monitor input selector switches. On both the A and B systems, these define the source for the monitor section from the possible 'primary' choice of stereo master (**ST**), mono master (**MONO**) or external (**EXT**). Additionally, each section has a talkback switch.

The function of the buttons in each source section is as follows:

- **TALK/[A and B]** switches, sum the talk back signals to the solo bus. The **talk mic** section (see "Talk mic" on page 154) has a level control knob that is shared between the two monitor paths.
- **ST** switch, routes post-fader stereo master mix to stereo local monitor outputs.
- **EXT** switch, routes stereo external input (two-track return etc.) to stereo local monitor outputs.
- **MON** switch, routes post-fader mono masters mix to stereo local monitor outputs.

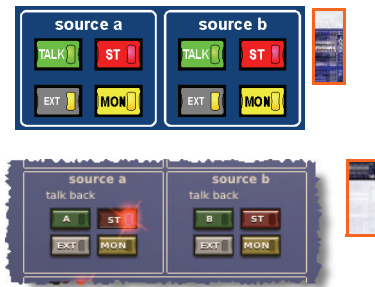

solo (a and b) sections

The solo signals can be selected for each monitor system (A and B) to be AFL, PFL, additive or interlock cancelling. PFL and AFL audio buses may accept injected external signals, and two control knob level controls make adjustments.

PFL and AFL levels are adjustable via the **pfl level** and **afl level** control knobs; see "solo system section" on page 149.

The function of the buttons in each solo section is as follows:

- **PFL** switch, sends mono pre-fader listen (PFL) solo bus signals to headphones and local monitor outputs. With PFL switch disabled (LED extinguished), stereo after fader listen (AFL) solo bus signals are sent to headphones and local monitor outputs.
- **ADD** switch, allows multiple channel access to solo buses. When solo add mode is off, pressing a solo switch cancels any currently active solos. Multiple solos (for example, stereo left and right signals) can be monitored in this mode provided solo switches are pressed at approximately the same time. When solo add mode is on, auto-cancelling is defeated, which allows multiple channel or output soloing. In this mode, input solos have priority over output solos and VCA solos, and will temporarily override them. When input solo is cancelled, output solo or VCA solos will return.
- **CLEAR** switch, illuminates when a solo switch is active in its monitor section and, when pressed, clears any solo switches in that section.



solo mode section (GUI only)

On the GUI, the **solo mode** section has a select button by which you can cycle through the solo mode options to select the one you want. Each option has an LED that illuminates when its option is selected.

The options are as follows:

- **normal** — both solo systems (A and B), are active and behave as a single solo system.
- **dual op.** — in dual operator mode, both solo systems (A and B) are totally independent of each other. The solo **B** button, in addition to routing the soloed material to monitoring system B, determines which set of **PFL**, **ADD** and **CLEAR** controls (see “solo (a and b) sections” on page 148) are applied to the solo.
- **lcr mon.** — left-centre-right monitor mode is similar to normal mode, but when nothing is being soloed the left and right masters are routed to the monitor A output and the mono master is routed to the monitor B output.

Pressing any solo switch on the control centre temporarily overrides the selected primary source selection, while the talk assignment is unaffected (this signal is summed further down the signal path, so as not to affect the monitor meters).

Each mode changes interleaving logic between different areas of monitor output.

- **broadcast** — routes stereo masters to the monitor A output and activates all the solo B controls so that soloed material is routed to the monitor B outputs. This allows the master outputs to be continually broadcast (probably the on-air program), while the other material is soloed.
- **user def.** — in user-defined mode, you can set up the monitoring system. These settings are recalled on return to this mode after using one of the other solo modes, for example, normal mode or broadcast mode. (User defined monitor settings are not stored in scenes or show files.)
- **surround** — all levels are controlled from the channel A fader.



solo system section

The **solo system** section has three control knobs, as follows:

- **pfl level** control knob — PFL audio bus may accept injected external signals. This control knob adjusts the pre-fader level in the range infinity (∞) to +10dB.
- **afl level** control knob — AFL audio bus may accept injected external signals. This control knob adjusts the after-fader level in the range infinity (∞) to +10dB.
- **talk back** control knob — adjusts the talk back level, in the range infinity (∞) to +10dB.



The following four sections in the **Monitors** screen allow you to patch the solo system signals.

- talkback input
- pfl direct input
- afl direct input left
- afl direct input right

For routing details, see Table 25 “Navigating to the Patching screen” on page 418.

Signal generator

The **signal generator** section can output to pink noise (pink noise generator) or sine wave tone (sinusoidal oscillator), and connect to the internal and external talk buses.

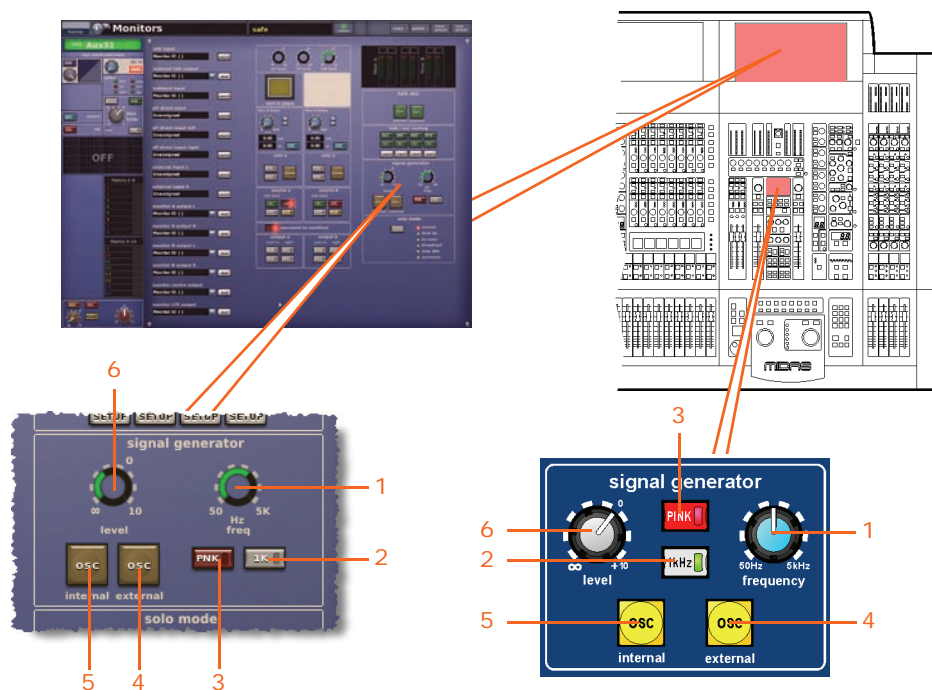

Signal generator controls on the control surface and GUI

Item	Element	Description
1	frequency/[freq] control knob	Gives continuous adjustment of the sinusoidal oscillator frequency from 50Hz to 5kHz.
2	1kHz/[1K] switch	Overrides the swept frequency control (item 1) and provides a fixed 1kHz tone.
3	PINK switch	Overrides the sinusoidal oscillator and converts output signal to pink noise.
4	OSC switch	This OSC external switch connects signal generator output to talk external output XLR.

<i>Item</i>	<i>Element</i>	<i>Description</i>
5	OSC switch	This OSC internal switch connects signal generator output to the control centre's internal talk and talk select buses. The internal talk bus can then be mixed onto any of the control centre's buses by pressing the internal talk switches associated with those buses, or mixed onto a group of buses by activating an internal talk group (see "Talk osc/routing" on page 152).
6	level control knob	Gives continuous adjustment of signal generator peak output signals from off (∞) to +10dB.

The **OSC** switches (internal and external) are the talk routing switches.

Talk osc/routing

The **talk / osc routing**, or 'internal talk groups' section, sends signal generator and talk mic signals to buses within the control centre. It contains eight talk group switches used for selecting the destination of the talk and OSC internal signals. Four of the talk group switches are user-configurable. The GUI has an additional four configuration switches for programming.

For information on programming, see "Programming the groups" on page 183.

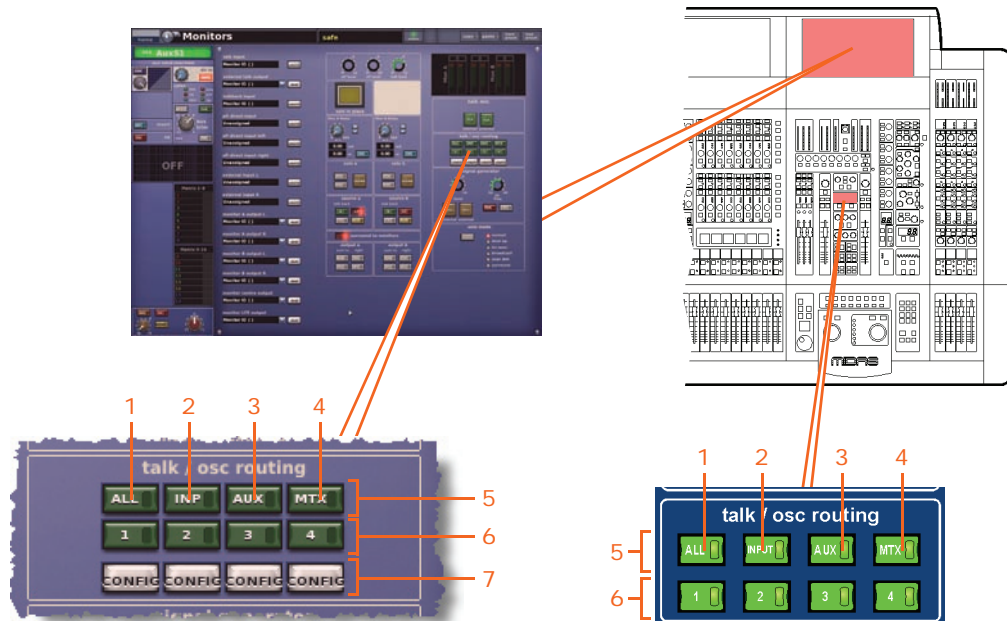

Talk osc/routing controls on the control surface and GUI

Item	Element	Description
1	ALL switch	Routes the talk/OSC internal signal to all outputs.
2	INPUT/[INP] switch	This input switch routes the talk/OSC internal signal to the input section.
3	AUX switch	Routes the talk/OSC internal signal to all auxes.
4	MTX switch	This matrix talk switch routes the oscillator or talk signal to the master outputs.
5	Switches	These are fixed bus talk group switches.
6	Switches	These are user-assignable talk group switches.
7	CONFIG switches	Each of these GUI only configuration switches opens the Talk Groups screen and selects its associated group, ready for programming (see "About the control group screens" on page 182).

Internal talk groups

You can assign talkback or send test signals to any audio bus on the PRO Series. Preset and user-configurable 'talk' groups allow you to, for example, talk to groups of performers in a monitor mix or make group announcements. Also, by using the internal tone oscillator, you can perform signal path testing and equipment alignment.

There are eight 'talk' groups available (four of each type), which are operated via pushbutton in the **talk/osc routing** section of the master bay. Using the preset talk groups you can route to all inputs, all auxes, all matrices or all outputs. Or, you can create your own talk groups (up to four) and choose which of these you want in each group; this is done via the GUI menu (see "Talk groups" on page 181).

Before you can select a talk group, the **TALK/internal** and/or **OSC/internal** buttons must be switched on. (This also applies to generator routing.) Also, if any internal talk or osc generator routing is active when the **TALK/internal** and/or **OSC/internal** buttons are both switched off, this routing is cancelled.

When a talk group is activated, all talk group member functions are activated.

>> To activate a talk group

- 1 Make sure either one or both of the 'internal' buttons, that is, the **TALK (internal)** button in the **talk mic** section and the **OSC (internal)** button in the **signal generator** section, are on.
- 2 In the **talk/osc routing** section, press the desired talk/oscillator routing button and hold down (for at least one second) until the button illuminates.

Talk mic

The control surface has an internal talk mic that lets you talk to external locations, and you can also be talked *to* from an external location.

For the input and output talk connections, see “talk section” on page 268.

Internal talk mic

This is located in the **talk mic** section, and contains the controls for both the internal talk mic and external talkback functions, which control a talkback microphone connected to the PRO Series Control Centre. Both functions utilise the compressor (limiter), which is in the microphone signal path immediately before the talk level control.

The outputs from the internal mic can be connected to the internal talk bus/talk external XLR output (see Appendix B “Functional Block Diagrams”).

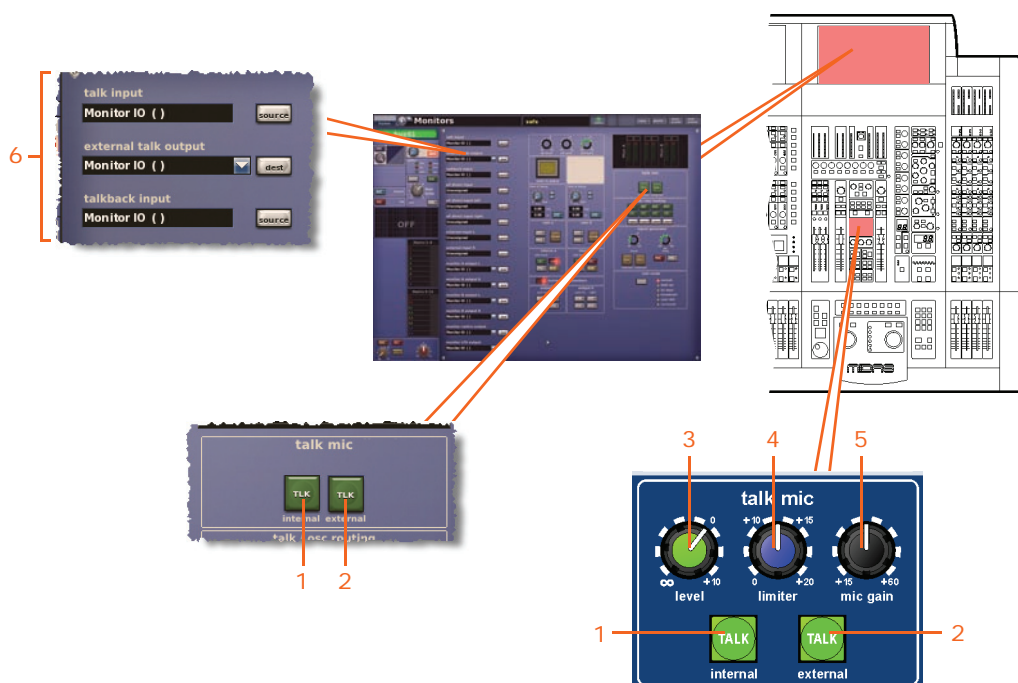

Talk mic controls on the control surface and GUI

Item	Element	Description
1	TALK/[TLK] switch	This talk internal switch connects the talk mic output to the control centre's internal talk system, while simultaneously dimming all local outputs by 20dB to prevent 'howl round'. The internal talk bus can then be mixed onto any of the control centre's buses by pressing the internal talk switches associated with those buses, or mixed onto a group of buses by activating an internal talk group (see "Talk osc/ routing" on page 152).
2	TALK/[TLK] switch	This talk external switch connects the talk mic output to the talk external output XLR.
3	level control knob	Gives continuous adjustment to the post-limiter signal from off (∞) to +10dB.

<i>Item</i>	<i>Element</i>	<i>Description</i>
4	limiter control knob	Gives continuous adjustment of the peak limiter value from 0dB to +20dB.
5	mic gain control knob	Provides continuous mic amplifier gain adjustment of the mic connected to mix bay control surface. Range is +15dB to +60dB and operates in conjunction with the peak limiter.
6	Talk patching sections.	See Table 25 "Navigating to the Patching screen" on page 418.

The three control knobs are used in conjunction with mic XLRs (in the screen housing and the rear connector panel) and the two **TALK** routing switches (internal and external).

>> To select the internal talk mic

- 1 In the **talk mic** section of the master bay, press **TALK (internal)** to switch in the talk mic section (see "Talk mic" on page 154).
- 2 In the **source a** or **source b** section of the master bay, press **TALK**. Your chosen section will determine which system bus (A or B) the talk mic will be sourced from (see "Monitor output (a and b) sections" on page 147 and "source (a and b) sections" on page 148).

External talkback

The external talkback input is a mic/line input at the stage end of the system that, when enabled in the monitor section (see "Monitor output (a and b) sections" on page 147), can mix onto the local monitor outputs.

Chapter 15: Graphic Equaliser (GEQ)

This chapter describes the internal GEQs of the PRO Series. Initially, it explains how to use the PRO Series Control Centre to configure and operate the GEQs and then details all of their available control functions.

Overview of the GEQs

The PRO Series Control Centre incorporates a graphic equaliser (GEQ), which is closely based on the Klark Teknik DN370 Graphic Equaliser (see Appendix C “Klark Teknik DN370 GEQ” for details). You can configure the PRO Series Control Centre to have set numbers of these GEQs up to a maximum of 28 (PRO3) or 36 (PRO6 and PRO9), and these are mutually inclusive of the number of effects you can have. For example, on a PRO6 and PRO9 you can have two effects and 32 GEQs, but if you want six effects you can only have 16 GEQs.

Each GEQ is a single-channel, 31-band, third octave graphic equaliser, and GEQ features switched 2nd order treble and bass filters and two notch filters with variable frequency ranges.

The GEQ is primarily a mono process, but in the case of stereo groups or mix channel outputs, a stereo GEQ is controlled from a single set of controls.

You can control the GEQs remotely using the Klark Teknik DN9331 Rapide Graphic Controller.

The GEQs are managed via a virtual eight-unit rack on the **Graphic EQs** screen. From here you can open the window of any GEQ, which gives you full control over it.

About the Graphic EQs screen

The **Graphic EQs** screen represents a virtual eight-unit rack of user-configurable GEOs. The number of units (shown in the **Graphic EQs** screen below) depends on the number of GEOs configured and the type of PRO Series Control Centre (see "To configure the PRO Series Control Centre with the number of GEOs and effects" on page 161).

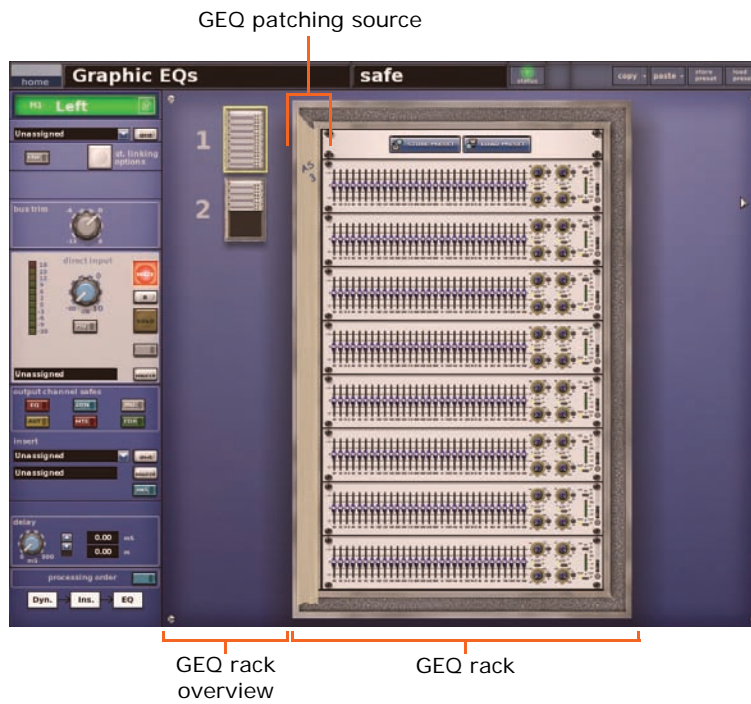

Figure 21: **Graphic EQs** screen (configured for 12 GEOs)

The main sections of the Graphic EQs screen comprise:

- **GEO patching source** The border to the left each GEO unit will display its source, if patched. In the diagram above, GEO 1 has been patched to "AS3" (aux 3).
- **GEO rack overview** This section contains an overview of the total number of GEO racks in use, and also aids GEO navigation/selection. The number of racks, which ranges from one to five, is dependent on configuration.
- **GEO rack** A 'virtual' rack containing up to eight GEOs. The rack also includes **STORE PRESET** and **LOAD PRESET** user library buttons (see Chapter 24 "User Libraries (Presets)" on page 235).

>> To open the Graphic EQs screen

Do one of the following:

- At the GUI, choose **home ▶ Rack Units ▶ Graphic EQs**.
- In the primary navigation zone, press the **effects/graphics** access button twice.

>> To open a GEO rack

In the **Graphic EQs** screen, click inside the desired unit.

About the GEQ window

On the GUI, the GEQ window shows a screen-width version of the selected GEQ's front panel. This gives you full control of the GEQ via the GUI controls (trackball and left and right buttons) in the primary navigation zone. Below the GEQ is an **assignable controls** panel (master bay GUI screen only), which lets you select and control the GEQ faders (singly or in groups) and the controls on the right.

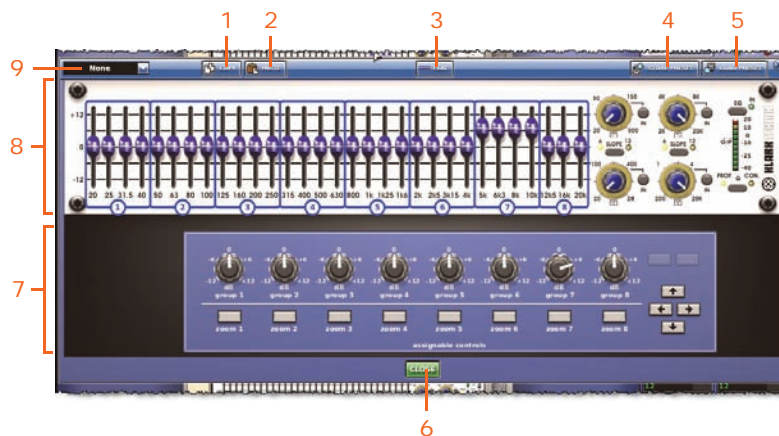

GEQ window

Item	Element	Description
1	COPY button	Copy and paste function button (see Chapter 18 "Copy And Paste" on page 185).
2	PASTE button	Copy and paste function button (see Chapter 18 "Copy And Paste" on page 185).
3	FLAT button	Sets all of the GEQ's faders to 0dB.
4	STORE PRESET button	See Chapter 24 "User Libraries (Presets)" on page 235.
5	LOAD PRESET button	See Chapter 24 "User Libraries (Presets)" on page 235.
6	CLOSE button	Closes the GEQ window.
7	assignable controls panel	See Chapter 19 "Assignable Controls (I Zone)" on page 187.
8	GEQ panel	Shows the front panel of the GEQ (see "GEQ front panel features" on page 160).
9	Drop-down list	For selecting the source of the GEQ.

>> To open a GEQ unit window

In the **Graphic EQs** screen, click on a non-control area of the unit you want.

>> To patch a source to a GEO

- 1 Open the window of the GEO.
- 2 Open the GEO source drop-down list. (An unpatched GEO will have "None" displayed in the text field.)
- 3 In the drop-down list, click the source you want. For example, "Aux Send 3". The new patching assignment will appear in the source name field (as shown right) and in the border on the left of GEO panel (see Table 21 "Graphic EQs screen (configured for 12 GEOs)" on page 158).
- 4 Click **CLOSE** to accept the change and close the GEO's window.

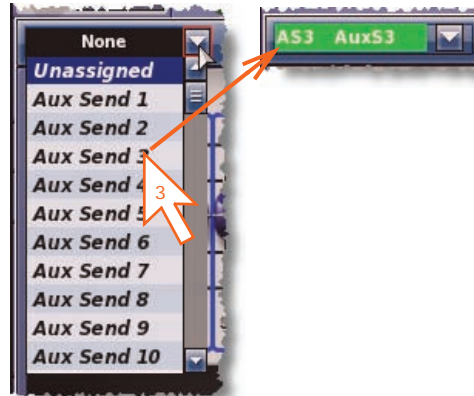

The new GEO patching source assignment will appear in the virtual rack (see Figure 21 "Graphic EQs screen (configured for 12 GEOs)" on page 158).

GEO front panel features

The front panel of the GEO, as displayed on the GUI, represents the Klark Teknik DN370 Graphic Equaliser. It includes a graphic EQ (faders) section and a filters section.

Thirty one faders provide fine adjustment of each frequency band. The 31 frequency bands are spaced 1/3 octave apart on the standard ISO 266 frequency centres. All the functions of the GEO can be bypassed via an **EQ** switch, such that the output will be the same as the input.

The GEO has one high pass filter, one low pass filter and two variable frequency notch filters. Each filter is adjusted via a control knob on the GUI screen. To addition the effect of the filters, use either the **EQ** switch (which will also bypass the GEO) or the individual filter switch.

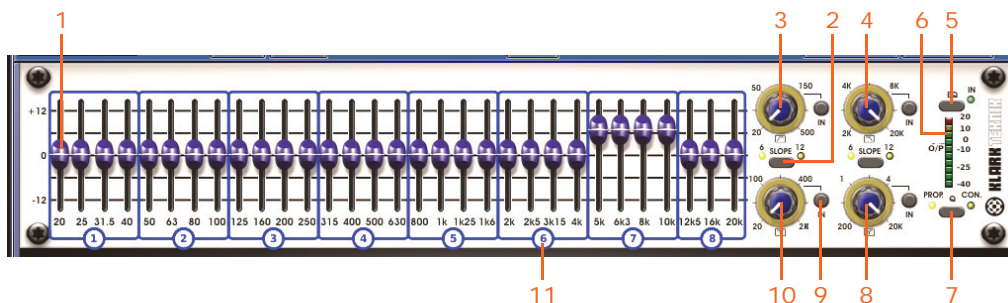

GEO front panel

Item	Control	Function
1	Fader (31-off).	Adjusts signal level.
2	SLOPE button	Switches the high or low pass filter between 6dB and 12dB. Adjacent yellow LEDs indicate the active band.
3	Low pass filter control knob	Adjusts the cut off frequency, which is continuously variable from 20Hz to 500Hz.
4	High pass filter control knob	Adjusts the cut off frequency, which is continuously variable from 2kHz to 20kHz.

<i>Item</i>	<i>Control</i>	<i>Function</i>
5	EQ button	Selects the EQ. The adjacent green IN LED shows the EQ is on (illuminated) or is being bypassed (extinguished).
6	10-segment meter	Shows the incoming signal level and is pre-EQ (but post-gain control). Clipping is post-EQ (and post-gain control), such that internal clipping due to excessive EQ, that is, if a high input level is further boosted by the use of EQ, will also be shown. The LED functions are: two red LEDs illuminate when signal has exceeded +20dBu and is being clipped; two yellow LEDs illuminate when signal level exceeds 0dB (range is between 0dB to +20dB); and the top five green LEDs encompass the signal level range of between 0dB and -40dB, while the bottom one illuminates when the signal has exceeded -40dB.
7	Q button	Selects proportional Q (PROP.) or constant Q (CON.) modes.
8	Notch filter control knob	Adjusts the position of the notch filter within the range 20Hz to 20kHz.
9	IN button	Switches the respective high pass/low pass/notch filter in/out.
10	Notch filter control knob	Adjusts the position of the notch filter within the range 200Hz to 2kHz.
11	Fader group ID number	See "Controlling a GEQ via the I zone" on page 194.

Configuring the number of GEQs (and effects)

GEQ (and effects) configuration is a GUI-only operation. We recommend that you configure the number of GEQs and effects before you start using the PRO Series.

>> **To configure the PRO Series Control Centre with the number of GEQs and effects**

- 1 At the GUI, choose **home ▶ Preferences ▶ General**.
- 2 In the **Effects and GEQs** section of the **Configuration Preferences** option, open the drop-down list (as shown right).
- 3 Select the option you want by clicking it. For example, click the **3 Effects - 28 GEQs** option (PRO6 or PRO9 only) to have three internal effects and 28 GEQs.

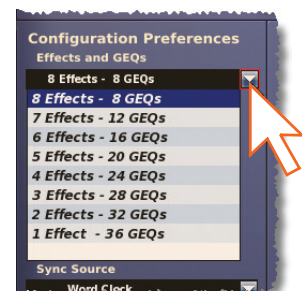



Typical **Effects** and **Graphic EQs** screens as configured for the **3 Effects - 28 GEOs** option. Note the four small racks to the left of the main rack on the **Graphic EQs** screen, which cater for the 28 GEOs; the selected rack unit is highlighted in yellow.

The following table shows the available **Effects and GEOs** options for the PRO Series.

Table 12: PRO Series effects and GEOs

<i>Number of effects</i>	<i>PRO3 GEOs</i>	<i>PRO6 GEOs</i>	<i>PRO9 GEOs</i>
1	28	36	36
2	24	32	32
3	20	28	28
4	16	24	24
5	12	20	20
6	8	16	16
7	N/A	12	12
8	N/A	8	8

Copying settings between GEOs

You can copy and paste all the settings of one GEO to another.

>> To copy the settings of a GEO to another GEO

- 1** In the GEO rack of the **Graphic EQs** screen, open the window of the GEO that you want to copy the settings from.
- 2** In the GEO window, click **COPY**.
- 3** Close the GEO window and then open the window of the GEO that you want to paste the settings to.
- 4** In the GEO window, click **PASTE**.

Chapter 16: Internal Effects

This chapter describes the internal effects of the PRO Series. Initially, it explains how to use the PRO Series Control Centre to operate the effects and then details all of their available control functions and their use.

Overview of the internal effects

The **Effects** screen manages up to eight user-assignable effects devices, collectively called the “internal effects pool”. This is a ‘bundle’ of onboard creative audio effects that provide onboard facilities where outboard effects units would have traditionally been required. The effects are displayed on the screen in a ‘virtual’ eight-unit rack.



Typical **Effects** screen containing all of the available effects. (The PRO3 only has six rack unit positions.)

All of the points in the control centre’s signal flow where outboard effects can be inserted, such as auxes and returns or insert points on input channels, audio subgroups, mix and master buses, can be patched to effects in the internal effects pool as well as external world XLRs. The following table shows the available internal effects and where they can be found in this chapter.

Internal effect	Section reference
Delay	“Delay effect” on page 166
Virtual DN780 Reverb	“Virtual DN780 Reverb effect” on page 168
Flanger	“Flanger effect” on page 170
Phaser	“Phaser effect” on page 171
Pitch Shifter	“Pitch Shifter effect” on page 173
SQ1 Dynamics	“SQ1 Dynamics effect” on page 174
3-Band Compressor	“3-Band Compressor effect” on page 175

Rack unit number allocation

Each unit position in the rack is allocated a rack number that is recognised by the PRO Series Live Audio System (shown right).



About the effect window

Similarly to the GEQ window on the GUI, the effect window shows a screen-width version of the selected effect, which gives you full control of the effect via the GUI controls (trackball and left and right buttons) in the primary navigation zone. A 'virtual' **assignable controls** panel below lets you select and operate the controls of the GEQ.



Effect window

Item	Element	Description
1	CHANGE DEVICE TYPE button	Lets you select a different effect.
2	STORE PRESET button	User library function button (see Chapter 24 "User Libraries (Presets)" on page 235).
3	LOAD PRESET button	User library function button (see Chapter 24 "User Libraries (Presets)" on page 235).
4	CLOSE button	Closes the effect window.
5	assignable controls panel	See Chapter 19 "Assignable Controls (I Zone)" on page 187.

<i>Item</i>	<i>Element</i>	<i>Description</i>
6	Effect panel	For details of the front panel for each effect, refer to the effect sections later on in this chapter.
7	Drop-down list	For selecting the source of the effect.

>> To open an effect window

In the **Effects** screen, click on a non-control area of the effect you want.

Working with the effects

There are a number of ways of handling the effects, such as setting up, configuration and operation, all of which involve the use of the GUI. However, most of these methods can also be carried out using the I zone; see Chapter 19 "Assignable Controls (I Zone)" on page 187.

>> To open the Effects screen

Do one of the following:

- At the GUI, choose **home ▶ Rack Units ▶ Effects**.
- In the primary navigation zone, press the **effects/graphics** access button.

>> To operate an effect control

The method for controlling the effect controls is the same as for any control on a GUI screen. For details, see "About GUI operation" on page 52.

>> To configure an effect

Similarly to the input channels, output channels, groups etc., you can change the name of an effect and the background colour of its text field, as it appears on the GUI (see "Configuring VCA/POP groups" on page 105).

>> To change an effect type

For details, see "To choose an effect" on page 110.

>> To route an effect

Effects are patched via the Patching screen. For details, see Chapter 8 "Patching" on page 71.

Effect configuration

The following versions are available for each effect type. The PRO Series selects the appropriate one automatically, depending on the configuration of the channel into which the effect is inserted:

- **Mono in and out:** for mono auxes and returns, mono input channel, audio subgroup and mix bus inserts.
- **Stereo in and out:** for stereo auxes and returns, stereo input channel, audio subgroup and mix bus inserts.

If the mono/stereo pairing status of a channel is changed while an effect is inserted, the effect will be replaced with the correct mono/stereo implementation.

Effect programs

Some types of effect have associated factory presets and user-configurable programs, which you can load within the effect (these are also stored in a show file). You can also save all of the controls from one or more effects in a user preset, which will then contain information about their settings, including the loaded factory preset or user-configurable program.

For details of each effect type, refer to its section in this chapter. For information on presets, see Chapter 24 "User Libraries (Presets)" on page 235.

Delay effect

The delay effect provides simple delay line based effects. Delay times can be specified manually or by means of a 'tempo-tap' button. Three-mode delay algorithm:

- **Single** — one delay tap (mono or stereo processing).
- **Dual** — two delay lines (stereo insert only).
- **Ping-pong** — two delay lines with cross feedback.

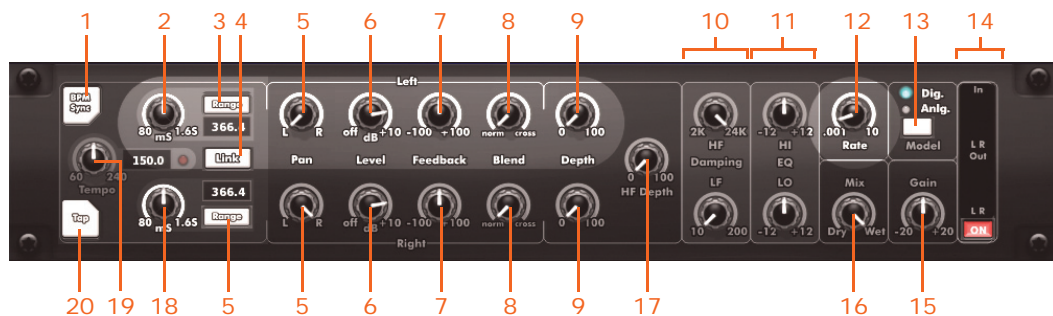

Front panel of the delay effect

Item	Control	Function
1	BPM Sync button	Activates BPM (TAP TEMPO) mode.
2	Left channel delay time control knob	For entering the desired delay time. Value is shown immediately below, in ms or BPM.
3	Range button	Selects one of three delay time ranges (1-25ms, 10-200ms or 80-1600ms). Value is displayed immediately below/above button.
4	Link button	Links delay time of left and right channels.
5	Pan control knob	Pans channel between L (left) and R (right) outputs.
6	Level control knob	Adjusts the output level. Range is from off to +10dB.
7	Feedback control knob	Adjusts the amount of negative/positive feedback applied to delay. Controls the number of repeats. Range is from -100% to +100%.
8	Blend control knob	Adjusts the feedback blend from norm to cross .
9	Depth control knob	Adjusts depth of delay modulation. Range is from 0 to 100.

<i>Item</i>	<i>Control</i>	<i>Function</i>
10	Damping section	Contains a HF control knob that adjusts the HF attenuation of delay repeats and an LF control knob that adjusts the LF attenuation of delay repeats.
11	EQ section	Contains a HI control knob that adjusts the amount of HF (high EQ) cut or boost applied to the output. LO control knob adjusts the amount of LF (low EQ) cut or boost applied to the output. Range of both is -12 to +12, with 0 at top dead centre.
12	Rate control knob	Adjusts rate of delay modulation. Range is between 0.001Hz and 10Hz, with 0.7Hz at top dead centre.
13	Model select button	Selects digital or analogue delay resolution. Current selection is shown by the illumination of one of the LEDs above (Dig. or Anlg.).
14	LR Out section	Contains an ON switch for activating delay.
15	Gain control knob	Adjusts the amount of gain between -20 and +20, with 0 at top dead centre.
16	Mix control knob	Adjusts the mix between dry (0%) wet (100%).
17	HF Depth control knob	Adjusts depth of delay modulation. Range is 0 to 100, with 50 at top dead centre.
18	Right channel delay time control knob	For entering the desired delay time (in ms).
19	Tempo control knob	Adjusts the tempo in tempo mode. Range is from 60 to 240 beats per minute (bpm).
20	Tap button	For manually tapping the tempo once the unit is in BPM Synch (TAP TEMPO) mode.

Virtual DN780 Reverb effect

The Virtual DN780 Reverb provides emulation of the vintage Klark Teknik DN780 Digital Reverberator/Processor unit. The DN780 is not just a reverberation device, it also gives the user a unique and flexible means of producing realistic acoustic simulations for environments of all types and sizes. The provision of effects programs further extends this versatility, making it a very powerful acoustic processing package.

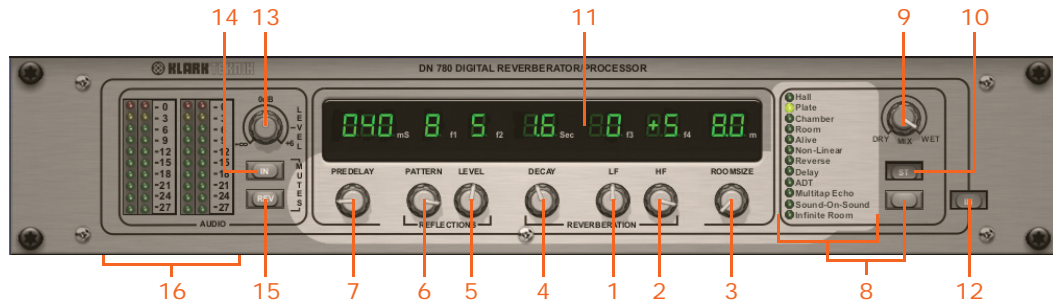

Front panel of the reverb effect

Item	Control	Function
1	LF (low frequency) control knob	REVERBERATION section control that adjusts the decay time at the low end of the reverb spectrum. Range is from -7 to +7.
2	HF (high frequency) control knob	REVERBERATION section control that adjusts the decay time at the high end of the reverb spectrum, which sets the absorption characteristic of the simulated space. Range is from -7 to +7.
3	ROOMSIZE control knob	Adjusts the average dimension of the simulated space. Range is from 8 to 90 metres. A momentary mute is implemented when this control is adjusted.
4	DECAY control knob	REVERBERATION section control that sets the overall (mid-band) reverberation decay time. Range is from 0.1 to 18 seconds, depending on room size.
5	LEVEL control knob	REFLECTIONS section control that acts as a 'depth' control by altering the apparent distance between the sound source and the listener. Alternatively, adjusts the input level for Sound-On-Sound/Infinite Room . Range is from 0 to 9.
6	PATTERN control knob	REFLECTIONS section control that controls the 'density' of early reflections. Selects the number and spacing of Early Reflections/ADT/Multi-tap delays. Range is from 1 to 9.
7	PRE DELAY control knob	Controls the amount of delay (in milliseconds) between the initial signal and the onset of reverberation. On certain program types, pre-delay is inserted between early reflections and reverb to improve authenticity. Its range is algorithm dependent.
8	List of algorithms and algorithm select button	Low level, phase-dependent 'clicks' are produced when pre-delay is altered during the program. These algorithms emulate the ones on the original DN780. Use the select button to scroll through the list to select the one you want.

<i>Item</i>	<i>Control</i>	<i>Function</i>
9	MIX control knob	Controls the DRY/WET output mix and ranges from 0% to 100%, respectively.
10	ST stereo input button	Enhances original algorithm to provide stereo input.
11	Parameter display panel	Shows the current settings for the selected algorithm.
12	IN button	Switches in the Virtual DN780 Reverb effect.
13	LEVEL control knob	AUDIO section control for adjusting the input level. Range is from $-\infty$ to +6dB, with 0dB at top dead centre. This should be set to illuminate the -3dB LED on the input headroom indicator during loud program passages.
14	IN button	AUDIO section MUTES control for removing feed to the reverberation section, enabling the decay qualities of the chosen setting to be confirmed.
15	REV button	AUDIO section reverb MUTES control for providing a rapid means of removing unwanted sounds.
16	Input headroom indicator	AUDIO section meters, which comprise two dual-column peak reading LED meters, ranging from 0dB to -27dB in 3dB steps. Each column consists of 10 coloured LEDs. The red LED illuminates at 3dB before the clipping point, which also provides an over-range warning for the arithmetical processor.

The parameter controls give accurate adjustment of all reverberation parameters and allow the engineer to create unique acoustic environments of virtually any type.

For more information on the Klark Teknik DN780, see Appendix D "Klark Teknik DN780 Reverb".

Flanger effect

The flanger effect consists of one or, if configured as stereo, two-tap delay lines. One tap is fixed and the other tap position is modulated to provide 'thru-zero' flanging or single tap modulation when 'thru-zero' is off.



Front panel of the flanger effect

Item	Control	Function
1	Delay control knob	Adjust length of modulated delay line in milliseconds. In 'thru-zero' mode, also sets the delay of the dry path. Range is 0.1 to 10, with 5 at top dead centre.
2	ON button	Switches the flanger effect on and off. Illuminates when power is on.
3	Feedback control knob	Adjusts the amount of negative/positive feedback applied to the delay. Controls the number of repeats. Range is from -100% to +100%, with 0% at top dead centre.
4	Modulation meter	A single row of 37 yellow LEDs are used to show the modulation.
5	Out meters	Two rows of 15 green LEDs, one each for L (left) and R (right).
6	In meters	Two rows of 15 green LEDs, one each for L (left) and R (right).
7	Gain control knob	Adjusts the signal level in dB. Range is from -20dB to +20dB, with 0dB at top dead centre.
8	Invert switch	Inverts the wet signal.
9	Mix control knob	Adjusts the mix between dry (0%) wet (100%).
10	Hi EQ control knob	Filters section control for adjusting the amount of HF (high EQ) cut or boost applied to the effect output (in dB). Range is -12dB to +12dB with 0dB at top dead centre.
11	Lo EQ control knob	Filters section control for adjusting the amount of LF (low EQ) cut or boost applied to the effects output (in dB). Range is -12dB to +12dB with 0dB at top dead centre.
12	HF control knob	Damping section control for adjusting the high frequency (kHz) tuning of flanger feedback. Range is 1kHz to 20kHz, with 10kHz at top dead centre.
13	LF control knob	Damping section control for adjusting the low frequency (kHz) tuning of flanger feedback. Range is 20Hz to 1kHz, with 140Hz at top dead centre.

Item	Control	Function
14	Depth control knob	LFO Sweep section control for adjusting the intensity of the effect by setting the depth of modulation as a percentage. Interactive with Delay, as for Chorus. Range is 0% to 100%.
15	Thru Zero switch	LFO Sweep section control for selecting 'thru zero' or normal mode. Illuminates to indicate switch is on.
16	Spread control knob	LFO Sweep section control for setting the relative phase of left/right modulation. Range is 0 to 180, with 90 at top dead centre.
17	Shape control knob	LFO Sweep section control for adjusting the shape of the modulation waveform. Range is from Tri to Exp.
18	Rate control knob	LFO Sweep section control for adjusting the rate of modulation (Hz). Range is between 0.01 and 50, with 0.7 at top dead centre.

Phaser effect

The phaser effect consists of one, or if configured for dual operation, two stereo phasers connected in serial/parallel according to mode setting.

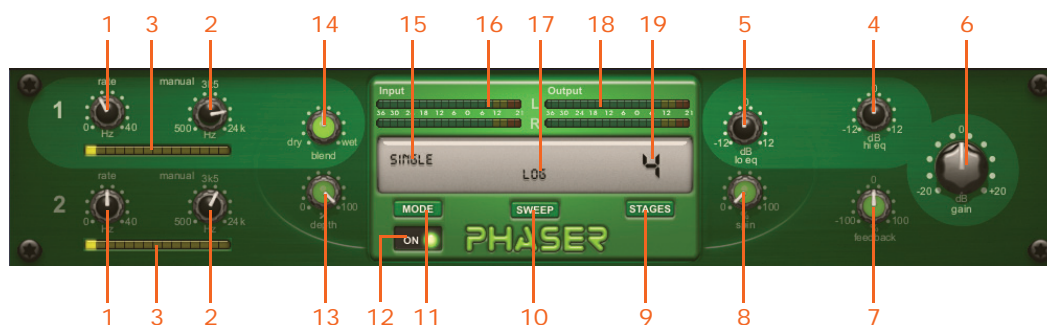

Front panel of the phaser effect

Item	Control	Function
1	rate control knob (channels 1 and 2)	Controls the rate of modulation in Hz. Range is from 0Hz and 40Hz.
2	manual control knob (channels 1 and 2)	Sets the sweep offset or performing manual sweep. Range is from 500Hz to 24kHz, with 3k5Hz (3,500Hz) at top dead centre.
3	Modulation meter	A single row of 15 yellow rectangular LED segments are used to show the modulation on each channel.
4	hi eq control knob	Adjusts the amount of HF (high EQ) cut or boost applied to the effect output (in dB). Range is from -12dB to +12dB with 0dB at top dead centre.
5	lo eq control knob	Adjusts the amount of LF (low EQ) cut or boost applied to the effects output (in dB). Range is from -12dB to +12dB with 0dB at top dead centre.
6	gain control knob	Adjusts the signal level (dB). Range is from -20dB to +20dB, with 0dB at top dead centre.

<i>Item</i>	<i>Control</i>	<i>Function</i>
7	feedback control knob	Adjusts the amount of negative/positive feedback applied to the delay. Controls the number of repeats. Range is from -100% to +100%, with 0% at top dead centre.
8	spin control knob	Adjusts the amount of relative phase of left/right modulation. Range is from 0% to 100%.
9	STAGES button	Selects the number of all pass stages, which sets the number of notches in the frequency response.
10	SWEEP button	Sets the modulation waveform shape.
11	MODE button	Selects the operating mode: single; dual series; dual parallel; linked series; or linked parallel. When linked, modulation of phasers 1 and 2 are linked.
12	ON button	Switching the phaser effect on and off. Illuminates to indicate effect is on.
13	depth control knob	Controls the intensity of the effect by setting the depth of phasing filters. Range is from 0% to 100%.
14	blend control knob	Adjusts the mix between dry (0%) wet (100%).
15	Mode	Displays the current mode, selected by the MODE switch.
16	Input meters	Two rows of 15 green LEDs — one row each for L (left) and R (right) — comprise the inputs meters.
17	Sweep	Displays the sweep, selected by the SWEEP button.
18	Output meters	Two rows of 15 green LEDs — one row each for L (left) and R (right) — comprise the output meters.
19	Number of all pass stages	Displays the number of all pass stages, selected by the STAGES button.

Pitch Shifter effect

The Pitch Shifter effect is a sound processing device for changing the pitch of an audio signal without changing its duration.

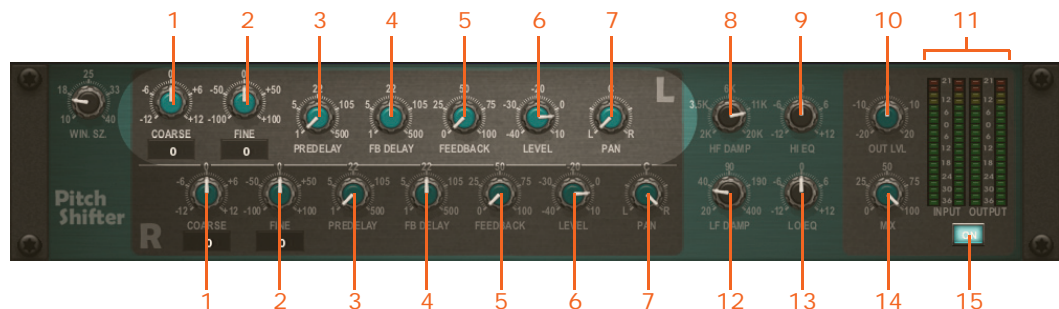

Front panel of the pitch shifter effect

Item	Control	Function
1	COARSE control knob	Adjusts the pitch shifting amount in whole tones. Range is from -12 to +12, with 0 at top dead centre. The numerical value is shown underneath.
2	FINE control knob	Fine tunes the pitch shifting in 1% increments of a whole tone. Range is from -100 to +100, with 0 at top dead centre. The numerical value is shown underneath.
3	PREDELAY control knob	Sets the delay time before the pitch shift. Range is from 1 to 500, with 22 at top dead centre.
4	FB DELAY control knob	Sets the delay time on the feedback loop. Range is from 1 to 500, with 22 at top dead centre.
5	FEEDBACK control knob	Sets the amount of feedback (output fed back to input) in %. For more details, see "Feedback" on page 174. Range is from 0 to 100, with 50 at top dead centre.
6	LEVEL control knob	Sets the output level of the individual channel. Range is from -40 to -10, with -20 at top dead centre.
7	PAN control knob	Adjusts the position of the individual channel signal in the unit's stereo output.
8	HF DAMP control knob	Adjusts the HF attenuation of delay repeats. Range is from 2k to 20k, with 6k at top dead centre.
9	HI EQ control knob	Boosts/attenuates high frequencies. Range is from -12 to +12, with 0 at top dead centre.
10	OUT LVL control knob	Sets the overall output level. Range is from -20 to +20, with 0 at top dead centre.
11	INPUT and OUTPUT meters	Shows the input/output signal levels on dual 20-segment meters (-36dB to +21dB).
12	LF DAMP control knob	Adjusts the LF attenuation of delay repeats. Range is from 20 to 400.
13	LO EQ control knob	Boosts/attenuates low frequencies. Range is from -12 to +12, with 0 at top dead centre.

<i>Item</i>	<i>Control</i>	<i>Function</i>
14	MIX control knob	Controls the balance between dry signal and effect. Range is from 0 to 100, with 50 at top dead centre.
15	ON switch	Switches pitch shifter effect on/off.

Feedback

The pitch shifter accepts the input signal and then delays it and plays it back at a different speed, so that its output is delayed and pitch shifted. When this output is fed back into the pitch shifter, further delays and more pitch shifting occur. This can lead to some strange effects, such as feedback.

SQ1 Dynamics effect

For information on the Klark Teknik Square One Dynamics, refer to its Operator Manual (part number DOC02-SQ1DYNAMIC).



Front panel of the SQ1 dynamics effect

3-Band Compressor effect

The 3-Band Compressor effect is for applying different compression profiles to different areas of the audio spectrum.

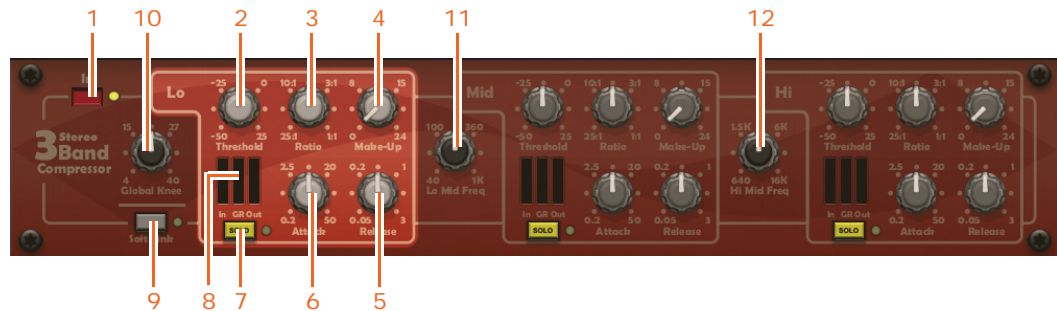

Front panel of the 3-band compressor effect

Item	Control	Function
1	In button	Switches the stereo 3-band compressor in/out. It has an adjacent LED (yellow) for in/out indication.
2	Threshold control knob	This control is in the Lo , Mid and Hi sections, and is used for setting the threshold at which compression begins. Range is from -50dB to +25dB.
3	Ratio control knob	This control is in the Lo , Mid and Hi sections, and is used for setting the compression ratio. Range is from 25:1 to 1:1.
4	Make-Up control knob	This control is in the Lo , Mid and Hi sections, and is used for boosting the output level of the compressed signal. Range is from 0dB to +24dB.
5	Release control knob	This control is in the Lo , Mid and Hi sections, and is used for setting the release time of the compressor. Range is from 0.05sec to 3sec.
6	Attack control knob	This control is in the Lo , Mid and Hi sections, and is used for setting the speed of the onset of compression once the threshold has been exceeded. Range is from 0.2ms to 50ms.
7	SOLO button	This control is in the Lo , Mid and Hi sections, and is used for listening to the compressor's sidechain filter. It has an adjacent LED (yellow) for on/off indication.
8	Three-section meter	This has individual meter elements for input (In), gain reduction (GR) and output (Out).
9	Soft Link button	Links the left and right channels. It has an adjacent LED (yellow) for on/off indication.
10	Global Knee control knob	Sets the rate of transition across the threshold. Range is from 4 to 40.
11	Lo Mid Freq control knob	Sets the crossover point between the Lo and Mid compressors. Range is from 40Hz to 1kHz.
12	Hi Mid Freq control knob	Sets the crossover point between the Mid and Hi compressors. Range is from 640Hz to 16kHz.

Chapter 17: Control Groups

PRO Series control groups comprise VCA/POP groups, auto-mute groups and talk groups. This chapter explains the function of each group and shows you the areas on the control surface and GUI that are used for their operation and management.

Many of the control group functions can be operated at either the control surface or GUI. Each control group has its own area on the control surface from where its groups can be set up and recalled, and there is a main option in the GUI menu (**Control Groups**) from which you can open the **Groups Sheet** screen and the group-specific screens. Using these screens, you can configure and operate the groups, and also manage group membership.

VCA and POP groups

Using the VCA/POP group controls, you can bring selected channels to the control surface for joint control. The VCA/POP group sections are situated at the bottom of the mix bay. When a VCA/POP is selected, its members are unfolded to the input bays.



POP groups (see page 178)

VCA groups (see page 179)

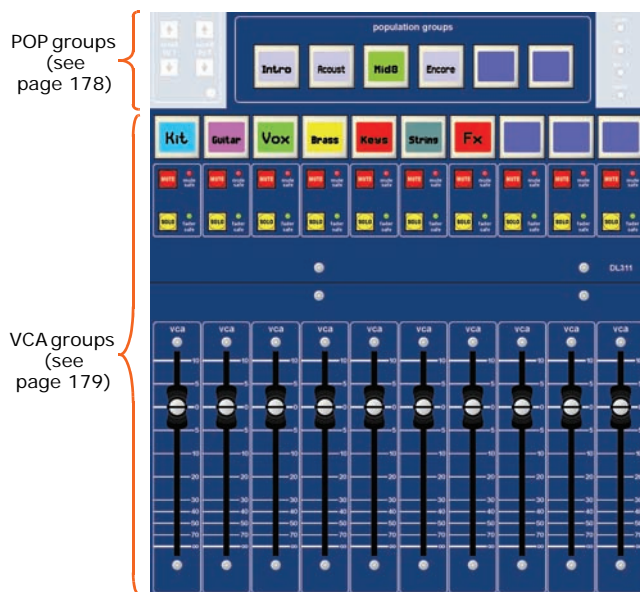

POP groups (see page 178)

VCA groups (see page 179)

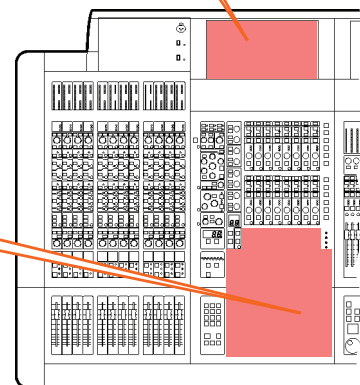

VCA and POP groups on the control surface and GUI

There are 10 VCA groups. Their controls, such as fader, LCD select button etc., are housed in fast strips at the bottom of the mix bay. POP groups, however, are fewer in number (six-off). These only have an LCD each, and are housed in a **population groups** section just above the VCAs.

The GUI provides full support for the hardware controls. This is in the **VCA Groups** screen of the GUI menu, which also includes an unfold button and a solo area **B** button for each group. This screen also provides VCA/POP group configuration and management functions.

Each VCA/POP group can have a combination of channel types as members, although it is usual to have only either inputs or outputs. Only the input channels are unfolded to the control surface (in the input bays).

>> To open the VCA Groups screen

At the GUI, choose **home ▶ Control Groups ▶ VCA Groups**.

VCA fast strips

The VCA groups section contains 10 VCA fast strips. Each strip contains an LCD select button, a solo routing section and a fader. The solo routing section activates solo routing and selects which monitor section (A or B) the signals are routed to. The GUI has additional controls.

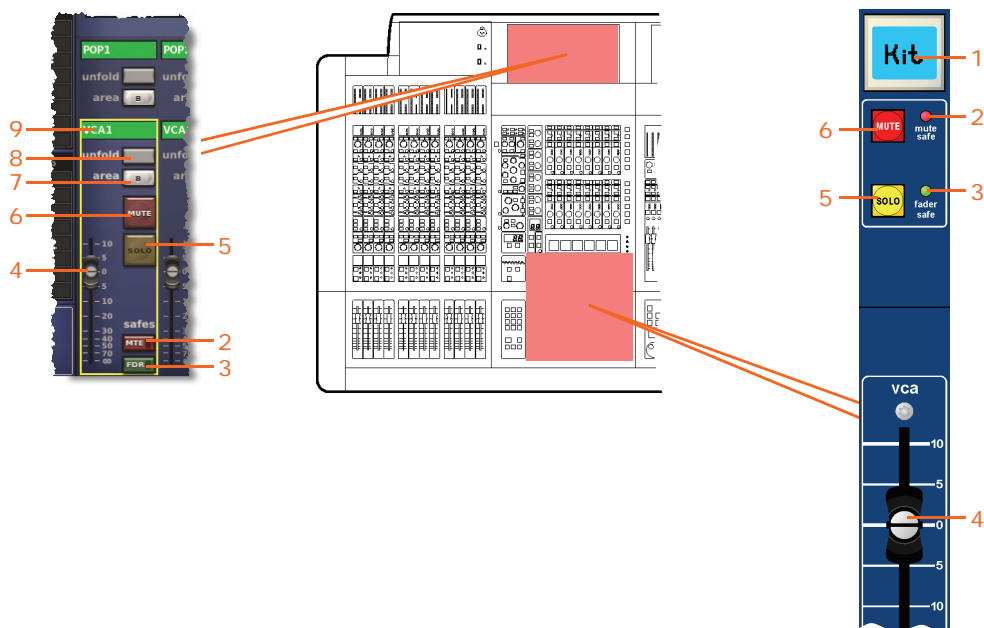

VCA fast strips on the control surface and GUI

Item	Control	Function
1	LCD select button	Selects the VCA group and is also used for group membership management. For more information, see "Navigating the input channels" on page 59.
2	mute safe LED	Illuminates to show that mute safe is on.
3	fader safe LED	Illuminates to show that the VCA control group fader has been removed from scene recall.
4	vca control group fader	Adds its level control on top of the local channel fader controls of the group members.

<i>Item</i>	<i>Control</i>	<i>Function</i>
5	SOLO button	Activates signal routing from all assigned channels to the monitor A section of the control centre. It is used to monitor the VCA master faders by creating a mix on the solo buses, which consists of all input channels and audio mix groups that are assigned to control from corresponding VCA masters.
6	MUTE switch	This is, technically, not a mute but a fader minus infinity ($-\infty$) switch that overrides the VCA group master (without moving its physical position). The VCA group mutes can be stored and recalled as part of the scene automation. When on, it mutes all post-fader signals from channels that have been assigned to the VCA group master (regardless of local press, scene mute and SIP mute, which affect only the mute status indicator while channel is muted by VCA). However, it does not update the mute status indicator on the channel (only channel outputs). On removal of the VCA mute, the channel outputs are updated to the current state of the channel mute status indicator. The VCA control group mute has been removed from scene recall and auto-mute action. When mute safe is active, all channel mute activation methods, other than by local press, are ignored. De-activating the mute safe condition re-evaluates and applies the current status of auto-mute and SIP mute.
7	Area B button (GUI only)	Changes input channel selection from default (area A) to those input channels set to area B mode — in the input bays.
8	unfold button (GUI only)	Assigns the VCA group to the control surface, unfolding the group members to the input bays.
9	VCA/POP group ID	Fixed and user-configured name of group.

POP groups

The POP groups have limited functionality (see “Using VCA/POP groups” on page 104). Each group has an LCD select button on the control surface and an unfold and area **B** button on the GUI. These controls function in a similar way to those in the VCA groups.

Working with VCA/POP groups

When you recall a group, its input channel members are unfolded to the control surface of the 12-channel input bay. They are displayed from right to left across the control surface in ascending order (according to channel number). When this bay is full, population starts at the right of the 4-channel input bay. Any input channel members remaining will not be visible, but they can be navigated to the control surface using the navigation controls (see “To assign an input channel to the control surface” on page 62).

When you deselect a VCA/POP group, its settings revert to those that were current when the group select button was last pressed. Recalling another VCA/POP group deselects the one currently selected.

For information on group selection and navigation, see Chapter 6 “Working With The Control Centre” on page 51 and Chapter 7 “Navigation” on page 59.

For details of VCA/POP group configuration and operation, see “Using VCA/POP groups” on page 104.

>> **To select another group**

With a group already selected, select another group by pressing the LCD select button of the desired group.

>> **To clear group selection**

Press the LCD select button of the currently selected group.

Auto-mute (mute) groups

You can simultaneously mute any channels you want. This is done by assigning them to an auto-mute group. You can have up to eight auto-mute groups, which are located in the **auto mute groups** section (just above the primary navigation zone). A group is muted by pressing its auto-mute button.

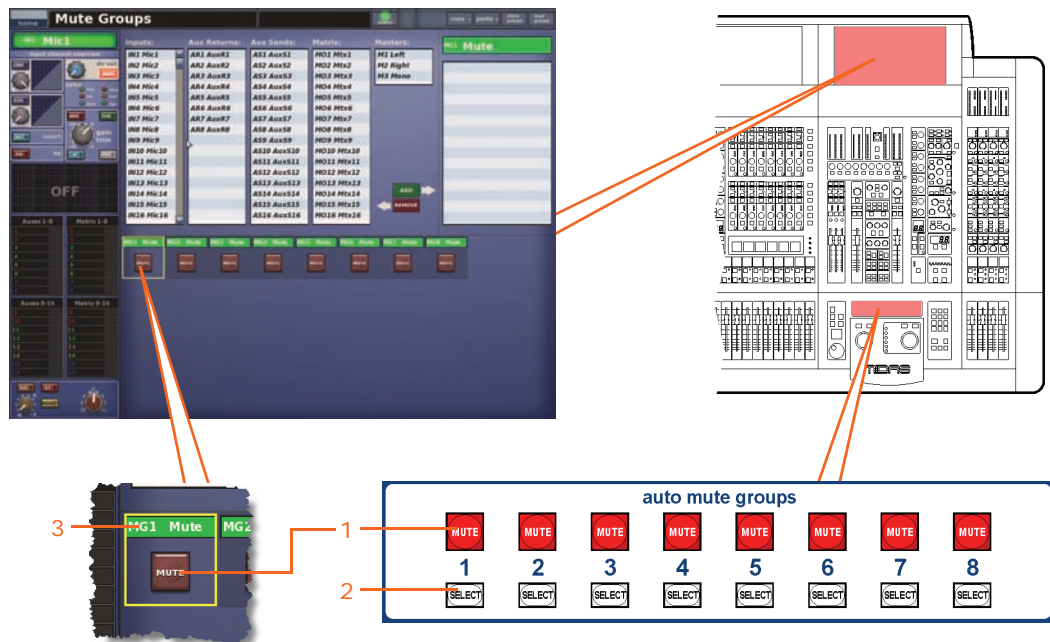

Auto-mute groups on the control surface and GUI

Item	Control	Function
1	MUTE switch	Mutes/unmutes all of the assigned channels. Also, the same channel can be assigned to more than one auto-mute group — the channel will be auto-muted, while any of the mute groups to which it is assigned are muted.
2	SELECT switch	Programs the auto-mute channel assignment. Shows current assignments to auto-mute group and allows them to be changed.
3	Name field	Default and user-configured auto-mute group name.

Auto-mute groups are managed via the **Mute Groups** screen, from where you can assign channels to any of the groups. You can configure the name and background colour of a mute group at the Groups Sheet screen (see “Configuring the groups” on page 184).

An auto-mute on can happen because of:

- Activating an assigned auto-mute.
- Assigning an already active auto-mute.
- Recalling a scene that assigns an already active auto-mute.

An auto-mute off can happen because of:

- Deactivating all of the assigned auto-mutes.
- Unassigning all of the active auto-mutes.
- Recalling a scene that de-assigns all of the active auto-mutes.

>> To open the Mute Groups screen

At the GUI, choose **home** ▶ **Control Groups** ▶ **Mute Groups**.

Talk groups

The **Talk Groups** screen manages the members of the talk groups. Each talk group section shares control with the talk osc/routing section on control surface (see “Talk osc/routing” on page 152).

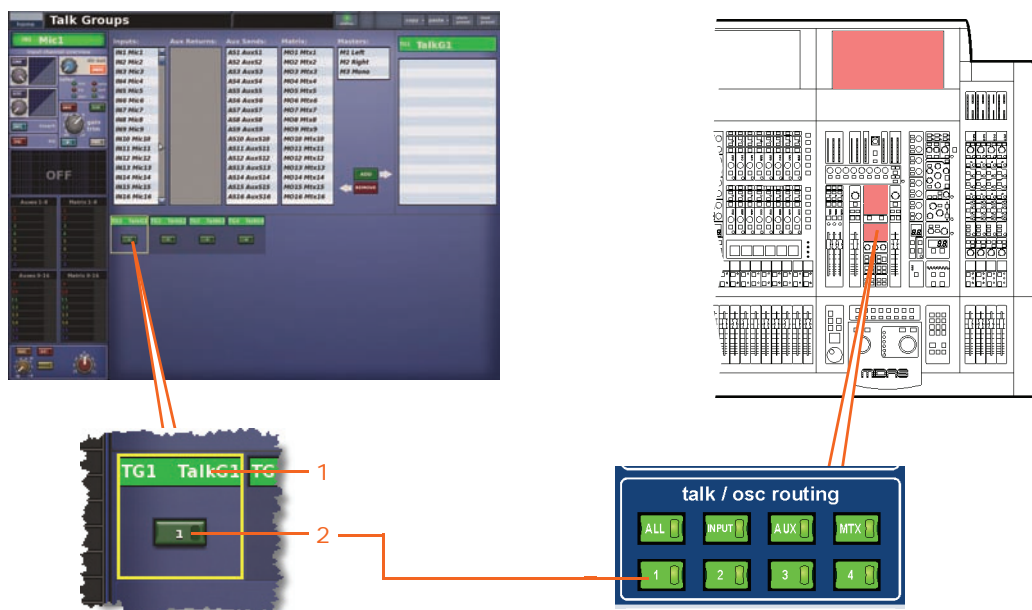

Talk groups on the control surface and GUI

Item	Control	Function
1	Name field	Default and user-configured talk group name.
2	Button	User-assignable talk group button.

>> To open the Talk Groups screen

At the GUI, choose **home** ▶ **Control Groups** ▶ **Talk Groups**.

>> To deactivate a talk group

Do one of the following:

- Press the button of the talk group that is currently active.
- Quickly press a talk group button other than the one currently active.
- Press and hold down (for more than one second) a talk group button other than the one currently active. This will activate the talk group whose button you are pressing.
- Switch off both the **TALK (internal)** and **OSC (internal)** buttons.

About the control group screens

Each type of control group screen has — apart from the channel strip, which is common to most screens — two main areas (shown right). The management section at the top lets you choose the group members, and is common to all control group types. While the bottom section contains the controls and sections specific to each type, which are described later on in this chapter.

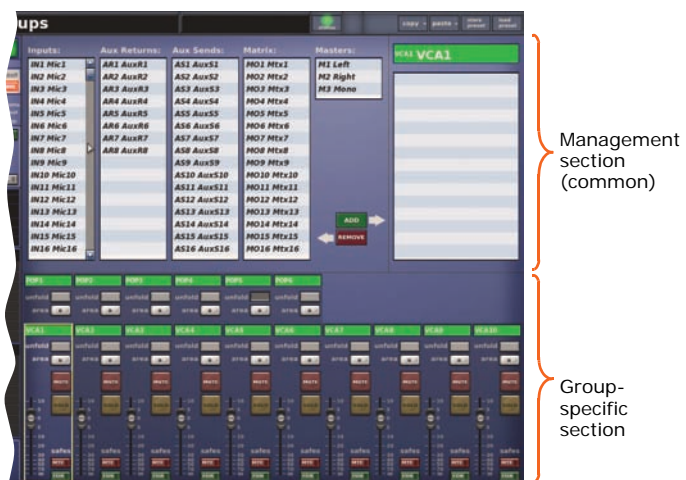

Management section

The group management section of each control group screen has two main panels. The left panel has five group-dependent lists of channels/mixes from which you can choose group members. The right panel contains the current group members (the example below shows a VCA group). Group members are moved between the two main panels using the **ADD** and **REMOVE** buttons.

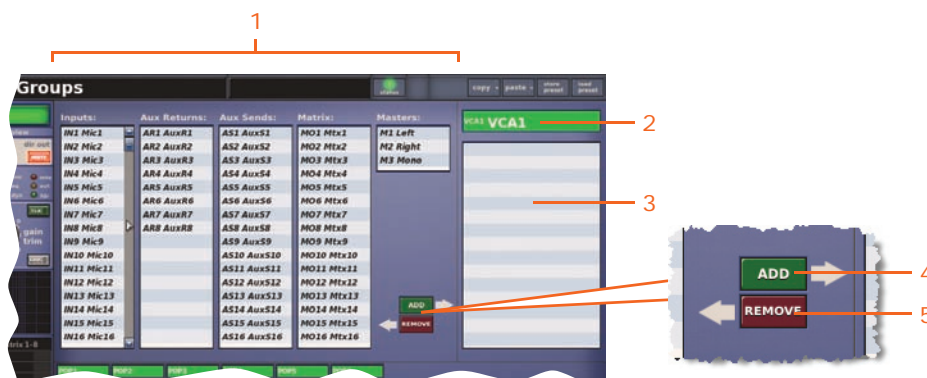

Typical management section of control group screen

<i>Item</i>	<i>Control</i>	<i>Function</i>
1	Group member selection lists	These group type-dependent lists let you choose which inputs, returns, auxes, matrices and masters you want as members in the selected group. If necessary, use the slider on the right of a panel to access all non-members.
2	Name field	Name of selected group.
3	Group member panel	List of the current members of the selected group.
4	ADD button	Moves the non-members (selected in the group member selection lists) to the group member panel, adding them to the group.
5	REMOVE button	Moves the members (selected in the group member panel) back to their respective group member selection lists, removing them from the group.

Programming the groups

In general, you can use either the control surface or GUI to create, manage and recall the groups. However, you might find it easier to use the GUI, as all of the channels are available simultaneously on the screen.

>> To program a VCA/POP group at the control surface

For details, see "Using VCA/POP groups" on page 104.

>> To program a mute group at the control surface

- 1 In the **auto mute groups** section (master bay), press and hold the **SELECT** button of your chosen auto-mute group.
- 2 Do one of the following:
 - To add inputs to the group, press the LCD select button of each input channel you want in the group. If necessary, navigate the desired input channels to the control surface.
 - To add outputs to the group, press the quick access button (bottom of each output fast strip) of each output you want in the group. If necessary, navigate the desired output channels to the control surface.

>> To program a VCA/POP, auto-mute or talk group at the GUI

- 1 At the GUI, open the screen of the desired control group type. For example, for a VCA group open the **VCA Groups** screen.
- 2 Click the group. For example, **VCA1**.
- 3 Click the channels that you want to add to the group.
- 4 Click **ADD**. The channels will be moved to the group member panel.

If you want to remove any members from the group, click the channels that you want to remove from the group (group member panel). Then, click **REMOVE**. The channels are moved back to their respective lists.

Configuring the groups

home ▶ *Control Groups* ▶ *Group Sheet*

The **Group Sheet** screen lets you change the name and background colour of each group as they appear on the GUI screen and LCD select switch (see “Configuring the inputs and outputs” on page 118). Additionally, you can change the colour of all the current members of the group to match the group colour by clicking the fill button .



Typical *Group Sheet* screen

>> To open the **Group Sheet** screen

At the GUI, choose **home** ▶ *Control Groups* ▶ *Group Sheet*.

Chapter 18: Copy And Paste

The PRO Series has a number of copy and paste features to make it easy to copy useful settings to other areas. You can copy and paste the following:

- **Processing areas across channels** — see “Using copy and paste” on page 118.
- **Parameters through scenes** — see “To copy and paste sections to a scene(s)” on page 117.
- **Scenes** — see “To create a new scene using the current settings” on page 115.
- **Shows** — see “To save a show or create a new one from the current settings” on page 113.
- **Events** — see “To copy and paste an event” on page 116.
- **Presets** — see “To create a new preset library from the current one” on page 237.

Channels versus scenes

The fundamental difference between copying through channels and copying through scenes is that the former is location-based, while the latter can be thought of as being time-based. However, the areas (and parameters) that are copied across are similar (see Appendix N “Parameters Affected By Copy And Paste” on page 511).

You can choose which control areas are copied and pasted across scenes via the **Show Editor** screen (see “Show editor” on page 117).

Chapter 19: Assignable Controls (I Zone)

This chapter describes the assignable controls (I zone) of the master bay and shows you how to use them to operate the internal effects and GEOs of the PRO Series, and also any of its control knob functions on the control surface.

About the I zone

The **assignable controls** section on the control surface — or “I zone” — has full GUI support (master bay GUI screen only) and operates in one of two ways:

- **Controlling any rotary on the control surface** You can assign any of the control knobs (rotaries) on the control surface — and also any belonging to the internal effects — to any control knob in the I zone.
- **Operating an internal rack unit of the PRO Series** You can adjust the critical controls of an internal effect or GEQ rack unit via the I zone.

Although you can switch back and forth easily between the two methods, the I zone gives precedence to the rack unit assignments.

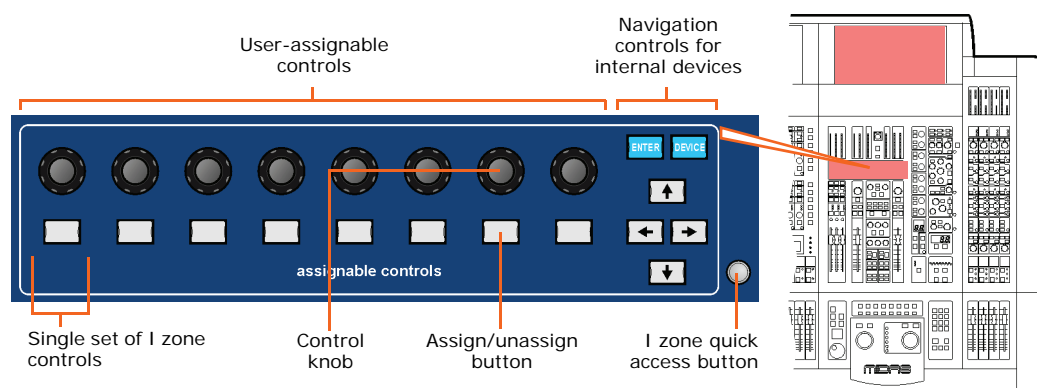

Figure 22: I zone controls on the control surface

Controlling a rotary control

This is an important function of the I zone, which lets you control any of the control knob functions on the control surface, such as **gain trim** (input fast strips), compressor/gate **threshold** (channel strip) and **level** (output fast strips), and even the internal effects. This means you can have quick access to the controls that are currently the most useful to you.

Additionally, you can assign the tap function of the Delay effect to an LCD button in the I zone, which lets you set a delay time manually. For details, see “To manually set the tap time of an effect” on page 189.

About the Assignable Controls window

The **Assignable Controls** window lets you choose which controls you can operate from the I zone. It shows the current assignment and status of each assigned control.



Item	Element	Function
1	Name field	Channel name, with background colour to match the default/user-defined channel colour.
2	Control knobs	User-assigned controls.
3	Button	Assign/unassign button.
4	Control selection lists	These offer you all the available options from which to choose your rotary control assignment.
5	Option list	Available control options for the selected channel/effect.
6	Option list	Available channels/effects for the selected channel type/effect.
7	Option list	Available channel types/effect. The options are: Unassigned ; Inputs ; Aux Sends ; Matrix ; Aux Returns ; Masters ; and Effects .

The following are some useful points to know about controlling a rotary control and the **Assignable Controls** window:

- You can assign any of the internal effects' rotaries to the **Assignable Controls** window.
- You can't use the **Assignable Controls** window with the GEQs.
- You can assign a control to the I zone via the control surface or the GUI.

>> To open the Assignable Controls window

- 1 Make sure that the master bay GUI screen is not displaying an internal device (effect or GEQ). If necessary, select another screen via the GUI menu or by pressing a screen access button in the primary navigation zone.

- 2 Press the I zone quick access button (see "I zone controls on the control surface" on page 187). The **Assignable Controls** window will open at the master bay GUI screen; in the example shown right no controls have been assigned.



>> To assign a control to the I zone

Open the **Assignable Controls** window and do one of the following:

- In the **assignable controls** section (I zone) on the control surface, press and hold down an I zone assign/unassign button. Operate the desired control; if necessary, navigate its channel to the control surface first.
- At the master bay GUI screen, open the **Assignable Controls** window and select the control you want to assign from the three panels at the bottom of the window (see "About the Assignable Controls window" on page 188). For example, choose the compressor ratio control of input channel 34. Then click one of the overlying assign/unassign buttons (as shown right).
- An alternative method is to press and hold down an I zone assign/unassign button in the assignable controls of the control surface. Then, on the GUI (master bay screen), click the desired control.

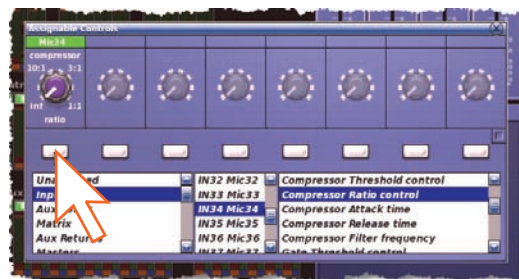

>> To unassign a control in the I zone

- 1 In the **Assignable Controls** window on the GUI, click **Unassigned** in the far left panel (bottom of window).
- 2 Click the desired I zone assign/unassign button.

>> To manually set the tap time of an effect

- 1 Assign the desired effect's delay time parameter to an I zone control. (Choose **Effects** in the left panel and then the desired channel and delay time parameter from the other panels.)
- 2 Tap the assign/unassign button of the I zone control (just as you would the **Tap** button of the effect) to achieve the desired tap time.

The PRO Series measures the interval between taps. It uses the most recent taps to calculate the average tap time, which is constantly updated according to each subsequent tap. This value is displayed on the effect's front panel in the appropriate **Range** field and is also indicated by the control knob immediately left.



Using the I zone to control an internal effect/GEQ

As the internal effects and GEQs of the PRO Series are primarily GUI-only features, control surface support is provided by the I zone, which lets you operate their parameters using physical controls.

With an internal rack unit selected at the master bay GUI, a set of its parameter controls will be automatically assigned to the I zone. Each individual set of I zone controls will have its own single control assignment. To encompass all of a rack unit's parameter controls they are bundled into sets — known as 'pages' for effects and 'groups' for GEQs — which are navigated using the I zone's arrow buttons.

About the assignable controls panel on the GUI

The **assignable controls** panel is displayed at the bottom of the effect/GEQ window (output bay GUI only). It gives a pictorial representation of the I zone and displays additional information, such as button and control knob assignments, current 'page' number etc. This panel also provides an alternative method of operating the I zone controls.

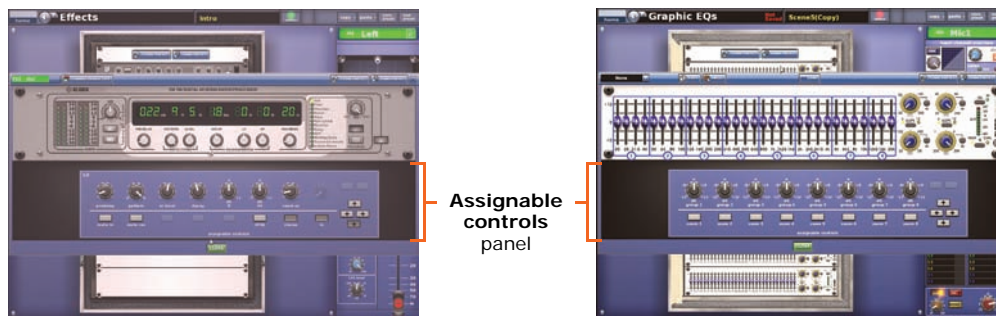

The following diagram explains the elements of the **assignable controls** panel. It uses the one for the effects as a example, but this also applies to the GEQs.



Item	Description
1	Effects only: Shows which 'page' of parameters is currently selected to the I zone, in the format: [page number]/[total number of pages]. For example, the diagram above is displaying page 1 of 3 pages.
2	Single set of I zone controls (button and control knob).
3	Assign/unassign button.

<i>Item</i>	<i>Description</i>
4	Effects only: Description of the effect's button currently assigned to the button. GEQ only: Will show either the text "zoom n" (where n is number from 1 to 8) or "overview" to indicate which display you are in, that is, overview or zoom, respectively.
5	Navigation buttons, which replicate the arrow buttons in the I zone (see Table 13 below).
6	Parameter description of the assignment of the overlying control knob.
7	Control knob. Includes gradations and dimensions applicable to the assigned parameter.
8	When an I zone control is unassigned, it is displayed as a 'ghost' image. (This also applies to the buttons.)

>> To operate the assignable controls panel at the master bay GUI

You can use the GUI to operate the effect/GEQ assigned to the I zone by doing any of the following:

<i>To</i>	<i>Do this in the assignable controls panel</i>
Select a different effect/GEQ	Click the up/down arrow buttons
Change the I zone control assignments	Click the left/right arrow buttons to navigate to a different page (effects) or zoom display (GEQs)
Operate a button on the front panel of an effect/GEQ	Click the desired LCD button
Operate a control knob on the front panel of an effect/GEQ	Use drag on the desired control knob

Rack and unit control navigation

The **assignable controls** panel on the control surface has four navigational buttons that let you select a rack unit on the GUI and choose which of its page/group of controls are assigned to the I zone.

Table 13: I zone navigation button functions

<i>Control button</i>	<i>Does this when controlling the effects</i>	<i>Does this when controlling the GEQs</i>
Left arrow	Scrolls through the 'pages' of the selected internal effect in descending order. This has no effect if you are already at the first page or there is no effect selected.	In zoom view, scrolls through the zoom displays. This has no effect if you are already at 'zoom 1' display. This has no effect in overview display.
Up arrow	Scrolls up the effects rack, changing unit selection accordingly. Stops at the top rack position.	Scrolls up the GEQ rack, changing unit selection accordingly. Stops at the top rack position.

Control button	Does this when controlling the effects	Does this when controlling the GEQs
Down arrow	Scrolls down the effects rack, changing unit selection accordingly. Stops at the bottom rack position.	Scrolls down the GEQ rack, changing unit selection accordingly. Stops at the bottom rack position.
Right arrow	Scrolls through the 'pages' of the selected internal effect in ascending order. This has no effect if you are already at the last page or there is no effect selected.	In zoom view, scrolls through the zoom displays. This has no effect if you are already at 'zoom 8' display. This has no effect in overview display.



*Don't forget that you can also operate the selected effect or GEQ in their respective rack unit view. For example, the **Effects** screen (shown right).*



>> To assign an internal effect/GEQ to the I zone

- 1 At the output bay GUI screen, do one of the following:
 - To control one of the internal effects (for example, a phaser) using the I zone, open the **Effects** screen.
 - To control one of the GEQs using the I zone, open the **Graphic EQs** screen.
- 2 Select the desired rack unit by doing one of the following:
 - In the I zone, use the up and down arrow buttons of the Shift function to navigate to the desired rack unit. Select the unit by pressing **SHIFT + open**.
 - At the output bay GUI, click the desired rack unit.

The window of the rack unit will open, containing the **assignable controls** panel at the bottom. A page/group of parameters will be automatically assigned to the **assignable controls** panel and the I zone.

You can now control the rack unit using the I zone.

>> To change the I zone control assignments

Click the left/right arrow button.

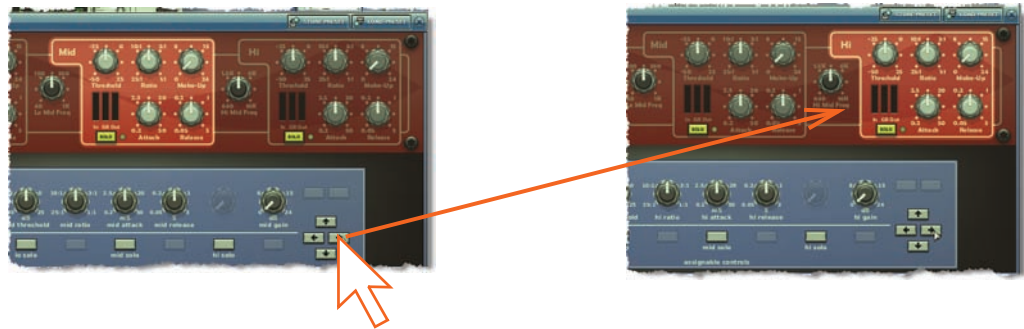

*In view 2/4 of the 3-band compressor effect the I zone is assigned to the **Mid** section. Clicking the right arrow takes you to view 3/4, and the I zone is now assigned to the **Hi** section. If you clicked the left arrow instead, this would take you in the opposite direction to view 1/4, and the I zone would be assigned to the **Lo** section.*

>> To change to another device in the rack

Click the up/down arrow button. This will open the next device (effect/GEO) in the device window. If there is no device assigned to the newly opened rack position, the device window will be empty.

Controlling an internal effect via the I zone

When controlling an effect, the GUI shows the current button and control knob I zone assignments.

>> To operate a button of an effect

- 1 Make sure that the effect's button you want to operate is assigned to the I zone. If necessary, navigate the effects page containing the desired button to the I zone. (The text at the top of the LCD button indicates its assignment.)
- 2 Press the desired I zone button.

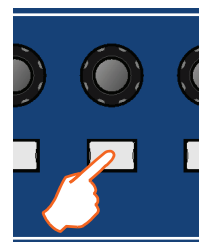
**>> To operate a control knob of an effect**

- 1 Make sure that the effect's control knob you want to operate is assigned to the I zone. If necessary, navigate the effects page containing the desired button to the I zone.
- 2 Adjust the desired control knob.

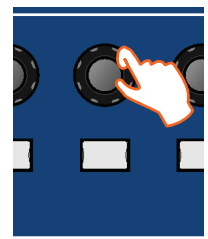

Controlling a GEQ via the I zone

You can use the I zone to adjust the faders and controls, such as the high/low pass filters, notch filters, slope etc., of an internal GEQ. For information on opening the **Graphic EQs** screen and selecting a GEQ, see Chapter 15, "Graphic Equaliser (GEQ)".

Similarly to the internal effects, there is an **assignable controls** panel on the GUI (see "About the Assignable Controls window" on page 188). However, to accommodate the faders there are, effectively, two levels of display, known as "overview" and "zoom".

The overview display appears initially when you open the window of the GEQ, and lets you adjust a group of GEQ faders simultaneously. Each LCD button in the I zone is assigned to a group of faders. For identification, the groups are numbered, as shown in the following diagram.

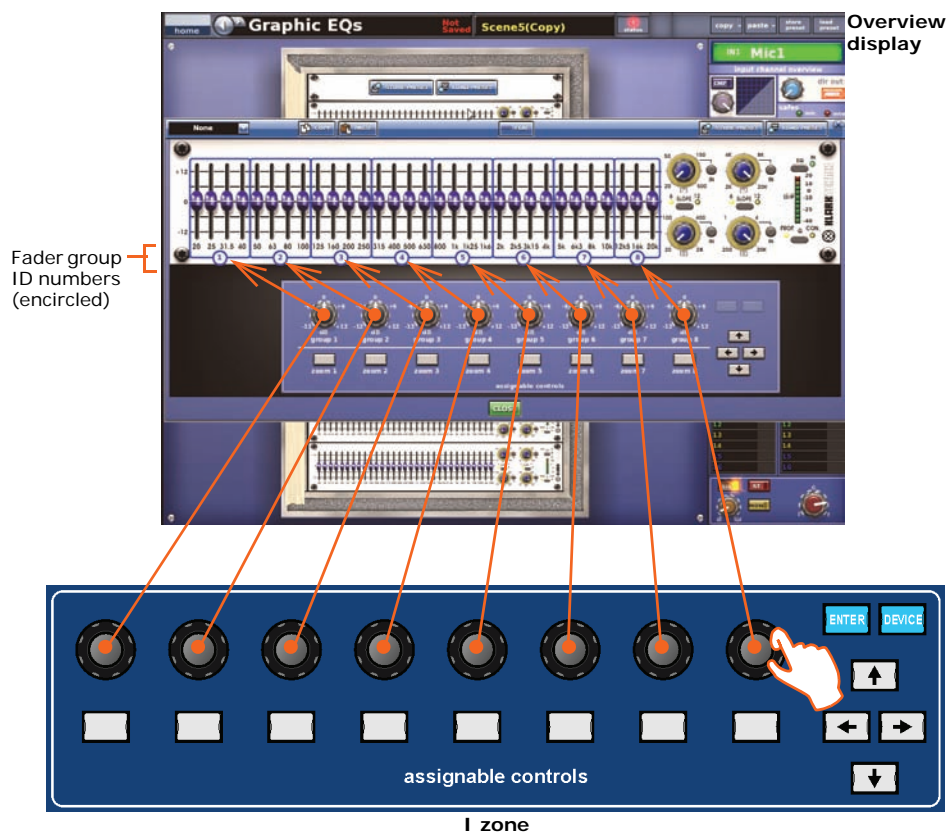

Figure 23: Fader group control knob assignments in the overview display

The zoom display comprises a number of screens, which are accessed via the LCD buttons of the overview display. The following diagram shows all of the available zoom displays and includes a typical example of what the assignable controls (control surface and GUI) will look like just after a GEQ has been selected.

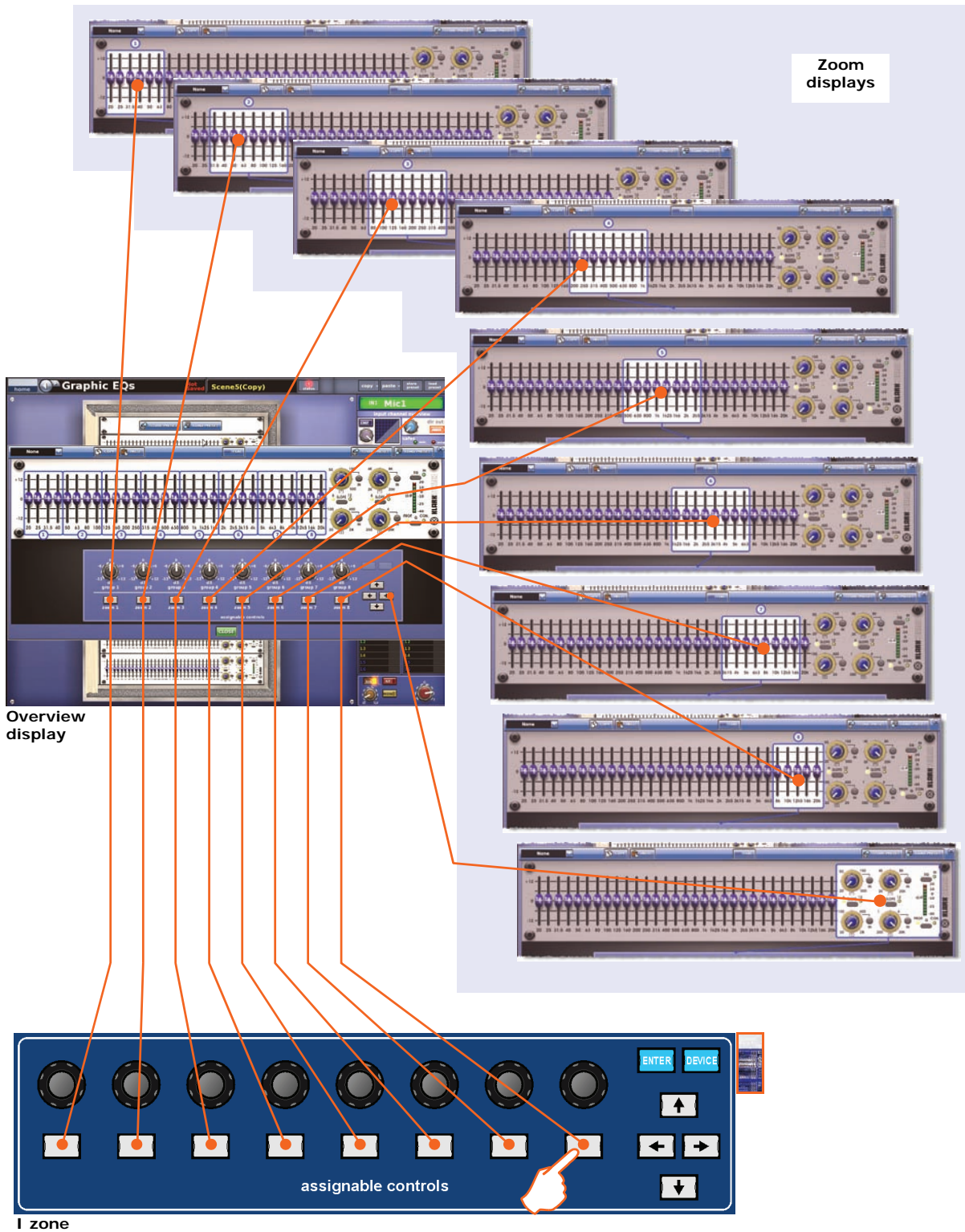

Figure 24: I zone LCD button assignments in the overview display

>> To switch between the overview and zoom displays

Do one of the following:

- To open the overview display from one of the zoom displays, press any of the LCD buttons in the I zone.
- To open a zoom display from the overview display, press the desired LCD button in the I zone.

>> To navigate the zoom displays

If you are at a zoom display and you want to go to another one (for example, to adjust a fader or front panel control) use the left and right arrow buttons in the assignable controls panel (see “Rack and unit control navigation” on page 191). For diagrams of the available zoom displays, see Figure 24 “I zone LCD button assignments in the overview display” on page 195.

>> To adjust a group of faders simultaneously in the overview display

Make sure the overview display is shown on the GUI and adjust the appropriate control knob in the I zone. The group of faders will adjust in equal amounts from their relative positions. However, continual adjustment will eventually take all of the group's faders to the maximum/minimum extent.

>> To adjust a single fader in a zoom display

If necessary, navigate the desired zoom display (containing the fader you want to change) to the GEQ window. In the I zone, adjust the desired control knob.

Note: You can also adjust a single fader in the overview display using drag, or in the rack view (with the GEQ window closed).

>> To operate a button or control knob of a GEQ

For details, see “To operate a button of an effect” on page 193 and “To operate a control knob of an effect” on page 193.

Chapter 20: Scenes And Shows (Automation)

This chapter shows you how to use scenes and shows, which are part of the PRO Series's automation.

About automation

Automation is predominantly a GUI-only function that allows complex editing of scenes and the creation of show files via the GUI menu. The control surface provides limited control via the **automation** section, which facilitates fast store/recall operation during show time and rehearsals.

The automation system of the PRO Series can store and recall up to 1000 scenes, each one being a snapshot of the control centre's settings at the instant the scene was created. By recalling scenes, users can — with certain exceptions — restore the control centre to the state that existed at that time the scenes were stored. This makes it ideal for multi-act tours by providing quick and accurate access of settings for the band with a minimum of sound check time, as well as for theatre productions, where each act requires reconfiguration of audio I/O.

All of the scenes for a show are contained within a show file. Show files are stored in the PRO Series, so that they can be loaded when required, and they can also be transferred to/from external USB storage devices.

Events provide an additional scene control by which you can use the MIDI, GPIO and 'internal' functions to trigger events on internal and external devices from within the show file.

For theatre applications, channel settings can be recalled (across all scenes) from the user library (see Chapter 24 "User Libraries (Presets)" on page 235) so that one generic show can cope with different performers on a night-by-night bases, which is common in theatres.

You can copy certain parameters through scenes by using the **Show Editor** screen. For more information on the **Show Editor** screen and for details on how to use it for copying and pasting throughout scenes, see "Show editor" on page 117. For details of the parameters that can be copied through the scenes, see Appendix P "Parameters Copied Through Scenes" on page 581.

Throughout this chapter, wherever scenes are mentioned this also applies to point scenes, unless otherwise stated.

Automation controls

Although automation is supported on the master bay control surface by the **automation** section, it also requires large amounts of screen support. The GUI provides this in the form of an **Automation** screen that gives full scene and show file support, and also scope and event features. Additionally, the GUI has a **Files** screen for show file management and transfer.

The following diagram explains the automation section of the control surface and shows the location of their equivalents on the GUI's **Automation** screen.

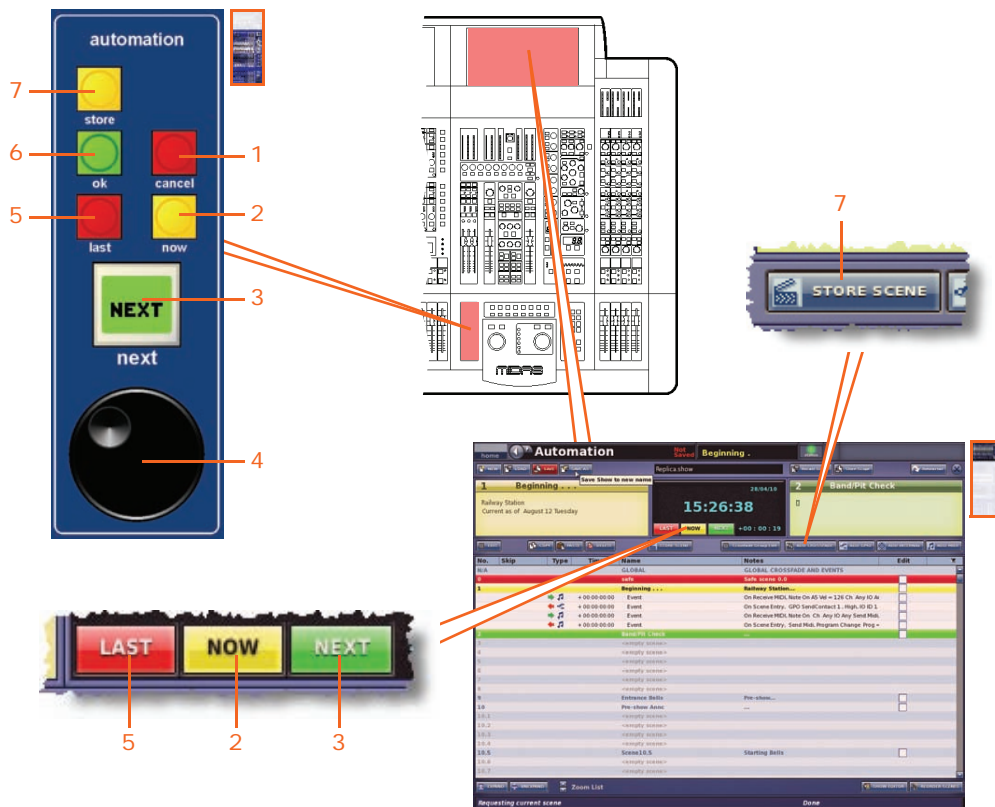

Automation controls on the control surface and GUI

Item	Control	Function
1	Red cancel button	Cancels a store operation and closes the Store window (illuminates to prompt when this button is active).
2	Yellow now/ [NOW] button	Recalls the currently highlighted scene in the cue list, clearing any unsaved adjustments.
3	Green next/ [NEXT] LCD button	Changes scene selection to the next scene/point scene (highlighted in green) in the cue list. For details of the button's display information, see "next LCD button" on page 199. (The GUI's NEXT button does not display any information.)
4	Jog wheel	Quickly dials the scene numbers beyond the capability of the 'last' and 'next' buttons by scrolling the 'now' scene through the cue list one scene/point scene at a time.
5	Red last/ [LAST] button	Changes scene selection to the previous scene (highlighted in red) in the cue list.

<i>Item</i>	<i>Control</i>	<i>Function</i>
6	Green ok button	Confirms an action (illuminates to prompt when this is necessary).
7	Yellow store/ [STORE SCENE] button	Opens the Store Scene window (see "To create a new scene using the current settings" on page 115) and lets you store the current settings to the currently selected scene.

next LCD button

The **next** LCD button in the **automation** section has two modes of operation—as a 'next' button and, when using the jogwheel, as a 'now' button. As a 'next' button it will display "NEXT" when there is another scene in the cue list — of higher value — that you can move to. When "End" is displayed the current scene is the last in the cue list. However, when using the jog wheel the **next** button's display changes to provide scene/point scene information (as shown right).

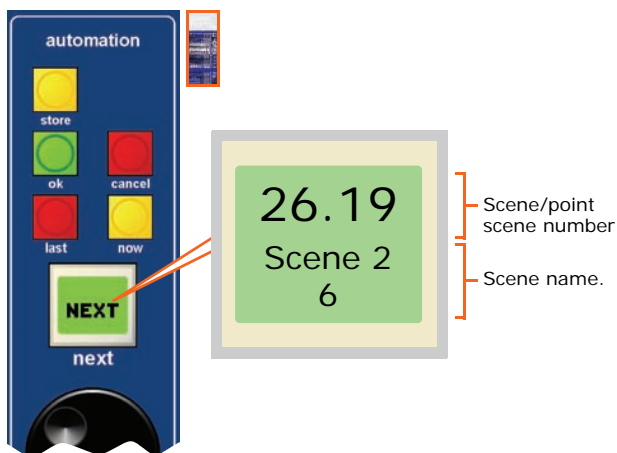

Automation screen

The **Automation** screen can be broadly divided into the following main areas (domains):

- **Scenes** — see "Scenes" on page 201.
- **Shows** — see "Show files" on page 209.
- **Scope** — see Chapter 21 "Scope (Automation)" on page 213.
- **Events** — see Chapter 22 "Events (Automation)" on page 221.

For details on how to open the Automation screen, see "To open the Automation screen" on page 112.

Using the right-click menu

You can access some of the functions of the function buttons and also additional ones by right-clicking the desired scene/point scene. This opens a menu (shown right) that has the following options:

- **Edit:** Opens the **Edit Scene Properties** window.
- **Add:** Opens a submenu with the following options:
 - **Overwrite Scene:** Overstores the scene with any changes made. For example, if you are working on scene 2, and you have made changes to it, right-click on scene 3 and then select **Add > Overwrite Scene**, and scene 3 will be overstored with the changes made to scene 2.
 - **Insert Scene:** Inserts the scene you have just copied immediately before this one.
 - **Midi Event:** Creates a MIDI event in the scene.
 - **Internal Event:** Creates an internal event in the scene.
 - **GPIO Event:** Creates a GPIO event in the scene.
 - **Crossfade Event:** Creates a crossfade event in the scene.
- **Delete:** Deletes the selected scene (see “Copying and deleting scenes” on page 206).
- **Copy:** Copies the selected scene (see “Copying and deleting scenes” on page 206).
- **Paste:** Pastes the scene you have just copied.
- **Expand:** Expands the scene/point scene (see “To expand a scene/point scene” on page 204).
- **Un-Expand:** Closes the point scenes of the scene/point scene (see “To expand a scene/point scene” on page 204).
- **Multi-Edit:** Opens a submenu with the following options:
 - **Set List:** Opens the **Set List** window.
 - **Show Editor:** Opens the **Show Editor** window.
- **Invert Selection:** Any scenes that have been ‘checked’ (that is, their check box in the **Edit** column contains an “X”) become unchecked, and vice versa.
- **Clear Selection:** Unchecks any scenes that have been checked.
- **Exit:** Closes the right-click menu.

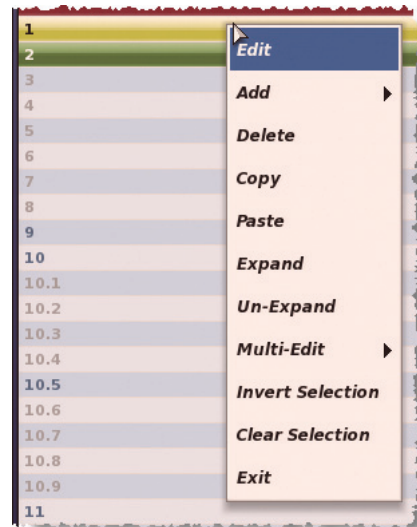

Scenes

The scene management areas of the **Automation** screen are intended for fast operation during show time and rehearsals. They let you edit, copy, delete, store and recall scenes, and can be broadly subdivided into the following areas.

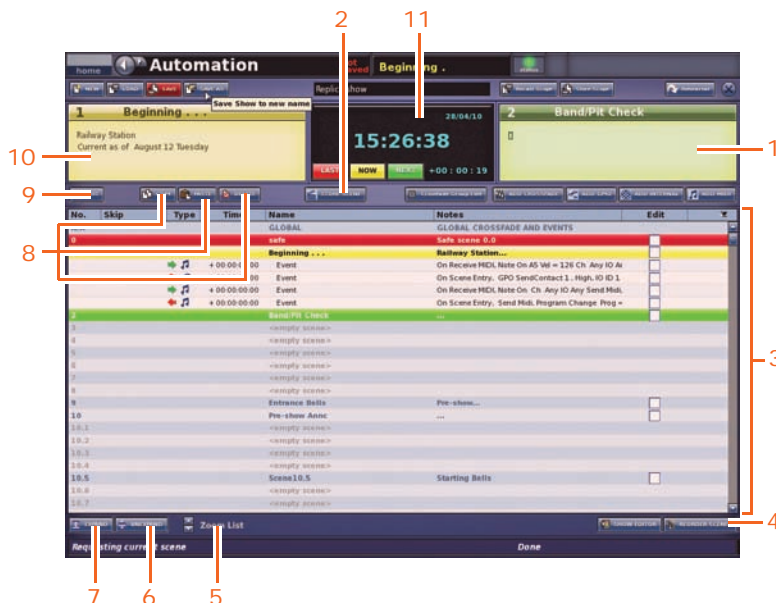

Scene-related elements of the **Automation** screen

Item	Element	Description
1	Scene panel	Contains scene number, title and notes pertaining to the 'next' scene.
2	STORE SCENE button	See "Automation controls" on page 198.
3	Scene cue list	See "Scene cue list" on page 203.
4	REORDER SCENES button	See "Changing the order of the scenes" on page 207.
5	Zoom List spin buttons	See "Using zoom" on page 208.
6	UNEXPAND button	See "To close the point scenes of a scene/point scene" on page 204.
7	EXPAND button	See "To expand a scene/point scene" on page 204.
8	DELETE, PASTE and COPY buttons	See "Copying and deleting scenes" on page 206.
9	EDIT button	See "Editing scene properties" on page 205.
10	Scene panel	Contains scene number, title and notes pertaining to the 'now' scene.
11	Show information panel	See "Date and time" on page 203 and "Automation controls" on page 198.

For details of how to navigate the scenes with the jogwheel, recall a scene and create a new scene from the currently selected one, see "Managing the scenes" on page 114.

Scene contents

A scene contains all of the control centre settings that existed at the point of creation, except:

- Anything that is explicitly taken out of recall (or store) using the automation scope controls.
- All solo, monitor and comms section controls.
- All surface selection or navigational control settings.

Additionally, each scene can contain:

- Scene information, including name and notes.
- Event (MIDI/GPIO/internal).

Point scenes

For every scene there are 10 point scenes available, and each point scene has another 10 point scenes. Point scenes are the same as scenes. They allow each scene to be divided into smaller sections.

Numbering and navigation

As scenes need to be recalled in sequence, each scene requires a sequential number. So, although there is a maximum of 1000 scenes, the range of scene numbers is much greater to allow for gaps to be left for adding scenes without having to renumber the subsequent scenes — a major requirement in scripted shows. To facilitate this, each scene has an associated four-digit, two-decimal place scene number, giving a possible 99 point scenes per main scene. The scene number locates the scene in the sequence of stored scenes and is the basis of scene navigation.

To navigate the scenes, the jogwheel on the control surface goes beyond the scope of the one-step automation buttons (**last**, **now** and **next**) by allowing you to scroll quickly from one scene to the next. Identification of current scene position is shown by the yellow background strip. The next and previous scenes are similarly highlighted, but by green and red, respectively.

Global scene

The **GLOBAL** scene, which is always at the beginning of the scene cue list, lets you create events that will be included in every scene. Global events are created just as you would for any other scene. Events of a similar type in other scenes will override the global ones.

Initial snapshot scene (scene 0)

All scene numbers are available for storing scenes except scene 0, which is called the “safe” scene. This scene is the control centre’s initial snapshot scene, and is created by the control centre and cannot be overwritten by the user. It is the only snapshot existing when the show is stopped or when the user subsequently clears the control centre down.

When recalled, it sets the control centre — regardless of scope settings — to a safe state in which it is not passing any audio. The settings include:

- All mutes off.
- Gains are set to 0dB.

- All levels are at minus infinity ($-\infty$) dB.
- All faders are at minus infinity ($-\infty$) dB — except VCA faders, which remain at 0dB.

Date and time

The current date and time, and the duration of the current scene are displayed towards the top of the **Automation** screen.



Scene cue list

The scene cue list provides you with an overview of the show. It tells you at a glance where you are in the performance and provides scene information, such as scene number and title. Other features let you alter settings, 'skip' scenes, edit scene properties and choose what to leave out of the cue list.

The screenshot shows a table with columns: No., Skip, Type, Time, Name, Notes, and Edit. The rows represent different scenes and events. Numbered callouts (1-11) point to specific features:

- 1: No. column
- 2: Skip column
- 3: Type column
- 4: Time column
- 5: Name column
- 6: Notes column
- 7: Edit column
- 8: Scene selection icon
- 9: Scene title
- 10: Scene notes
- 11: Scene selection icon

Elements of the scene cue list

Item	Element	Description
1	No. column	Number column shows the scene number and point scene number.
2	Skip column	Skip column. When you see a skip arrow  in this column it means that this scene will be missed out during a rehearsal. For example, during rehearsal you may need skip scene 3 by going straight from scene 2 to scene 4 (auto status). Also, indicates scene selection when it contains an event (yellow circle).
3	Type column	Shows the type of events and whether they are incoming or outgoing.
4	Time column	Displays the time before an event is triggered. A blue countdown time bar shows the time remaining.
5	Name column	Title of scene/point scene or name of event.
6	Notes column	Scene notes.

<i>Item</i>	<i>Element</i>	<i>Description</i>
7	Edit column	Contains a tick box per scene/event, which is used for selection purposes when reordering scenes, see “Changing the order of the scenes” on page 207.
8	Eye symbol 	Opens the Show window (see “Configuring the scene cue list view” on page 205).
9	GLOBAL scene	See “Additional control — managing events” on page 116.
10	safe scene	See “Initial snapshot scene (scene 0)” on page 202.
11	Scroll bar	Lets you scroll to the other scenes.

>> To select a scene/point scene

The ‘now’ scene is the currently selected scene (highlighted in yellow).

Do one of the following:

- At the GUI, click the scene/point scene in the **Automation** screen.
- At the GUI, click the **LAST/NOW/NEXT** button in the **Automation** screen as necessary.
- In the **automation** section (control surface), press the **last/now/next** buttons as necessary.
- In the **automation** section (control surface), operate the jogwheel to go to the desired scene/point scene. Then press **now**.



When recalling a scene, you can avoid replacing the current settings by using scope masks, see Chapter 21 “Scope (Automation)” on page 213.

>> To expand a scene/point scene

Select the scene/point scene and do one of the following:

- Click **EXPAND**.
- Right-click the scene to open the right-click menu. Then, choose **Expand**.

>> To close the point scenes of a scene/point scene

Select the scene/point scene and do one of the following:

- Click **UNEXPAND**.
- Right-click the scene to open the right-click menu. Then, choose **Un-Expand**.

Configuring the scene cue list view

You can exclude certain elements from the scene cue list (see “Scene cue list” on page 203), such as events and empty scenes. This is done via the **Show** window (shown right), which has the following options:

- **Empty scenes** — excludes all empty scenes from the show.
- **Global events** — excludes all global events from the show.
- **MIDI events** — excludes all MIDI events from the show.
- **GPI/O events** — excludes all GPIO events from the show.
- **Internal events** — excludes all internal events from the show.

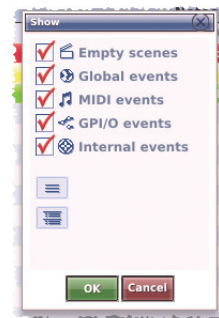

>> To configure the scene cue list view

- 1 Click the eye symbol  (right of the cue list title bar) to open the **Show** window.
- 2 In the **Show** window, select the desired options.
- 3 Click **OK**.

Editing scene properties

You can change the name of a scene, add/edit its notes (also editable in the **Store** window when storing a scene) and choose to skip the scene during a rehearsal. This is all done via the **Edit Scene Properties** window (shown right).

The **Scene Name** and **Notes** sections are edited just as you would any other text field.



>> To open the Edit Scene Properties window

Do one of the following:

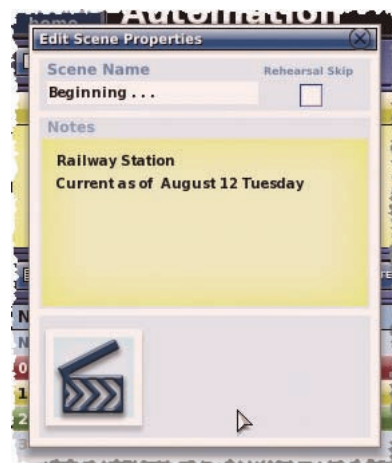
- Select the scene and then click **EDIT**.
- Right-click on the scene and then choose **Edit** from the right-click menu.



>> To skip a scene during rehearsal

Open the **Edit Scene Properties** window of the desired scene, and then click the **Rehearsal Skip** box to place a red cross  inside it. After you close the window, a skip arrow symbol  will appear in the scene's **Skip** column.

Adding a new scene

You can add a new scene anywhere in the cue list. The new scene can be inserted in the cue list or you can overwrite an existing scene by replacing it with the new one.

>> To insert a new scene

- 1 Right-click the scene before which you want to insert the new one.
- 2 From the right-click menu, choose **Insert Scene**.

>> To overwrite an existing scene with a new one

- 1 Right-click the scene you want to overwrite.
- 2 From the right-click menu, choose **Overwrite Scene**.

*Note: If you are creating the first scene, use **STORE SCENE** (see "To create a new scene using the current settings" on page 115).*

Copying and deleting scenes

You can copy and delete single scenes/point scenes from the cue list.

>> To copy a scene

- 1 Do one of the following:
 - Select the desired scene and click **COPY**.
 - Right-click the desired scene and then choose **Copy** from the right-click menu.
- 2 In the cue list, select the scene/point scene before which you want to paste the copied scene. Then, click **PASTE**.

>> To delete a scene

- 1 Do one of the following:
 - Select the desired scene and then click **DELETE**.
 - Right-click the desired scene and then choose **Delete** from the right-click menu.
- 2 In the message window (shown right), click **OK**.

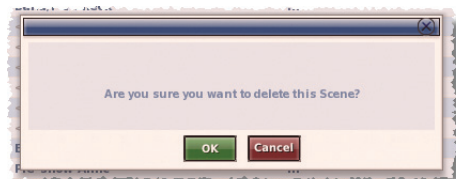

Changing the order of the scenes

You can change the order of the scenes in the cue list. This is done using the **REORDER SCENES** button. You can reorder as many scenes as you want by selecting them in the order you want them to appear in the reordered list.

>> To reorder the scenes

- 1 At the **Automation** screen, click **REORDER SCENES**. The grey double arrowhead symbol  will appear in each box in the **Edit** column.
- 2 In the cue list, click the box of the first scene you want to reorder (as shown right). A "1" will appear in the **Edit** column, signifying that it will be the first of the reordered scenes, and the scenes will be reordered from this point on in the cue list.
- 3 Repeat for the next scene you want to reorder. This will be labelled "2" in the **Edit** column.
- 4 Repeat for the remaining scenes/point scenes.
- 5 Click **REORDER SCENES**. The message window (shown right) will open.
- 6 Click **OK**.

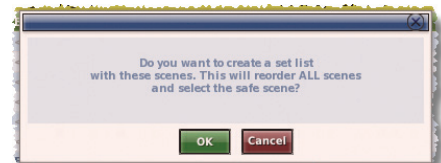

Overriding store scope

You can choose to ignore the parameters selected at the **Store Scope** screen, so that these 'safed' parameters *will* be stored in the scene. This is selectable as a global option (for all scenes) in the **Preferences** screen and also on a per scene basis in the **Store Scene** window.

Note: *This feature does not affect scene recall.*

>> To override the safe parameters (selected in store scope) for a single scene

Open the **Store Scene** window (see "To create a new scene using the current settings" on page 115) and select the **Overwrite Safe parameters?** option.

>> To override the safed parameters (selected in store scope) for every scene

At a GUI screen, choose **home ▶ Preferences ▶ General** to open the **Preferences** screen, and select the **Overwrite Safed parameters** option (see “Changing the user interface preferences” on page 250) in the **User Interfaces Preferences** section.

Using patching in automation



Caution:

The **Automate Patching** option switches on per-scene automatic routing, and must be used with caution. To alert you to the drastic consequences of using this option, a **WARNING** window appears.

You can change the patching of certain sources and destinations on a per-scene basis. For example, you have an input channel's compressor side chain patched from one source in one scene and from a different source in another scene.

For details of the parameters that can be patched per scene, see Appendix L “Parameters Affected By Automate Patching”.

>> To use patching in automation

At a GUI screen, choose **home ▶ Preferences ▶ General** to open the **Preferences** screen, and then select the **Automate Patching** option in the **Configuration Preferences** section.

Using zoom

You can enlarge the cue list to zoom in on certain scenes or make the scenes in the cue list smaller so that you can view more scenes simultaneously. This is done using the **Zoom List** spin buttons.

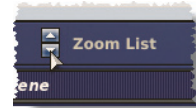

>> To enlarge the scene view (zoom in)

In the **Automation** screen, click the up (top) **Zoom List** spin button. The diagram right shows a typical **Automation** screen at maximum zoom.

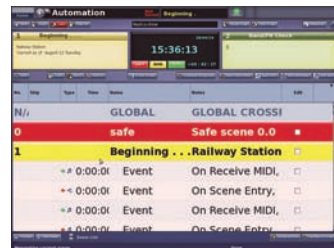

>> To reduce the scene view (zoom out)

In the **Automation** screen, click the down (bottom) **Zoom List** spin button. The diagram right shows a typical **Automation** screen at minimum zoom.

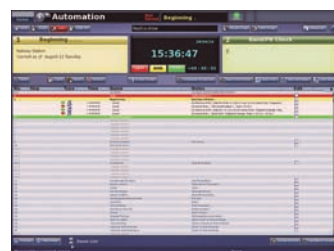

Show files

Show files are only handled via the GUI, using the **Automation** and **Files** screens of the GUI menu.

Managing show files

The **Automation** screen lets you create new shows, load existing ones and update the current show file with the latest settings.

For details of how to use the show function buttons to create a new show, save a show, create a new show from the current settings and load a show, see “Managing the shows” on page 112.

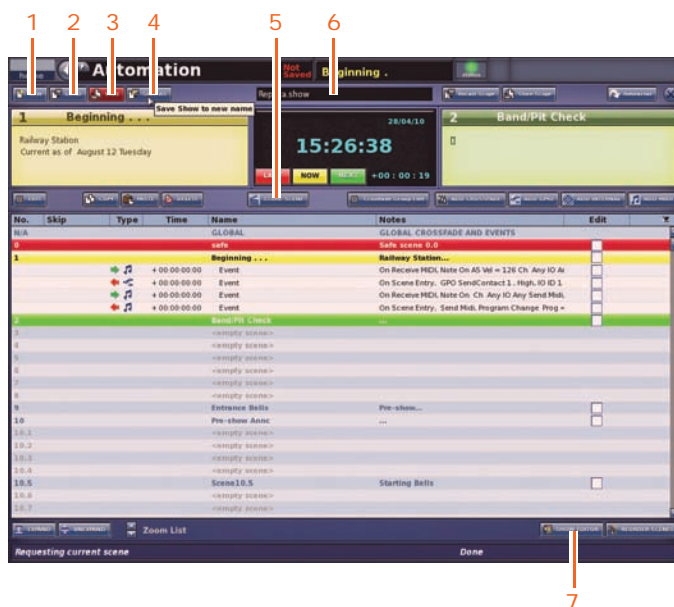

Show file-related elements of the **Automation** screen

Item	Element	Description
1	NEW button	For creating a new show (see “To create a new show” on page 112).
2	LOAD button	For loading a stored show by restoring all stored snapshots and associated automation data from the selected show file (see “To load a show” on page 113).
3	SAVE button	For backing up all stored snapshots and associated automation data to the selected/current show file (see “To save a show or create a new one from the current settings” on page 113). This button changes to red when there are show settings to be saved. We recommend that you save your show at regular intervals.
4	SAVE AS button	For creating a new show using the settings of the current one (see “To save a show or create a new one from the current settings” on page 113).
5	STORE SCENE button	See “To create a new scene using the current settings” on page 115.

<i>Item</i>	<i>Element</i>	<i>Description</i>
6	Name field	Title of currently loaded show.
7	SHOW EDITOR button	See "Show editor" on page 117.

Managing show files on the Files screen

Show files can be transferred between the PRO Series and an external USB device, such as a USB memory stick. This lets you backup and archive your show files, so none will be lost, and also transfer them to other PRO Series systems. You can even create templates for new shows, so that you don't have to start from scratch, or modify existing show files. All this is done via the Files screen; see Chapter 25 "File Management" on page 239.

For details of how to back up/export your files and also how to import them from an external source, see "Saving your show files to a USB memory stick" on page 123.

Rehearsals

Rehearsal mode lets you skip scenes/point scenes to match the arbitrary nature of the performance sequence during rehearsals.

>> To select a scene to 'skip' and to 'unskip' a scene

See "Editing scene properties" on page 205.

>> To carry out a rehearsal

- 1 Click **REHEARSAL**.
- 2 Carry out the rehearsal as necessary. (Note how the scenes selected as 'skipped' are missed out during the show's rehearsal, as you use the last, now and next buttons.)
- 3 To end the rehearsal, click **REHEARSAL**.

Safes

Important:

Safes are intended for emergency use only and are not to be confused with scope (see Chapter 21 "Scope (Automation)" on page 213).

Safes are incorporated into the PRO Series to prevent certain controls from being recalled with a scene. Safe activation and status are provided on both the control surface and the GUI.

There are six types of channel safe: EQ, dynamic, mic/config., auto, mute and fader. Although some types of safe are channel-specific, any channel can be made safe from off-channel mute, fader and automation control. Also, solo (for monitor areas A and B) is always out of scene on any channel.

Note: The **MIC** button on the outputs operates as a configuration safe, rather than a mic safe.

All of the channel safe areas, except **MIC** safe, have local LEDs on the control surface to show their in/out status, which are provided in each channel/group fast strip and in the safes sections of the overview and processing area displays of the GUI channel strip.

VCA groups only have mute and fader safes, and these can only be only switched on/off via the GUI; see "VCA and POP groups" on page 177. Mute safe status indication is provided both on the control surface (VCA/POP group section of master bay) and in the GUI channel strip.

For details of which parameters are protected by the safes, see Appendix M "Parameters Protected By Safes" on page 469.

Chapter 21: Scope (Automation)

This chapter shows you how to use the scope feature of the PRO Series automation to include/exclude specific parameters on scene store/recall.

Although scope has two functions, recall and store, the emphasis in this chapter is on recall scope, which will be the most commonly used of them both. Store scope will only be required in certain circumstances, and even then it must only be used with caution (see “Using store scope” on page 219).

About scope

Scope lets you define the extent of the automated controls for all channels, buses, groups, assignable effects and GEQs. To do this it has a **Recall Scope** screen from which you can select the controls that are excluded from the scene when it is recalled and you can also view the current scope status.

About the Recall Scope screen



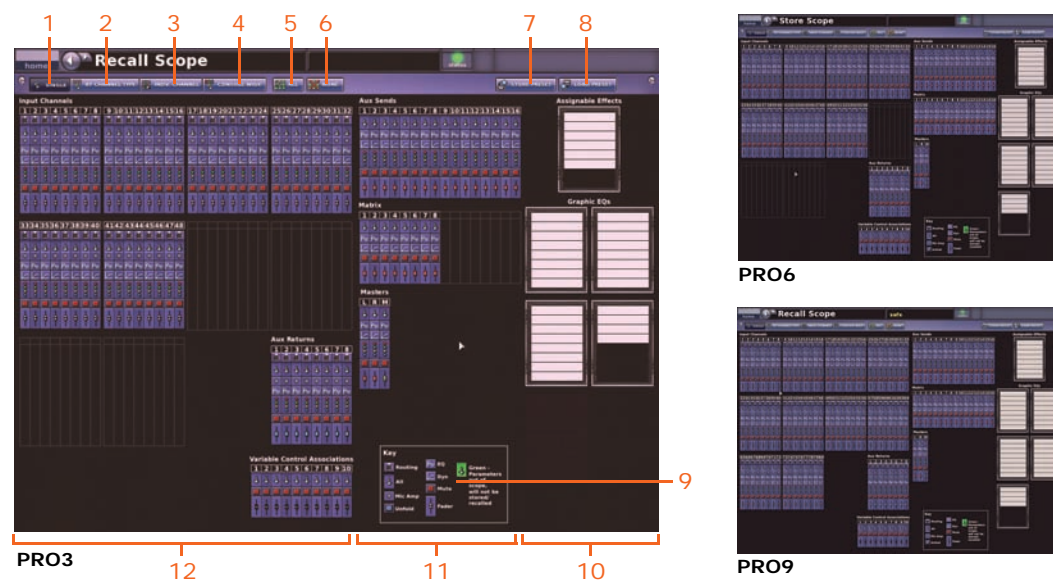





The **Recall Scope** screen has a number of type-specific areas, such as **Input Channels**, **Aux Sends**, **Variable Control Associations** and **Graphic EQs**, which contain user-selectable parameter sections that you can make ‘out of scene’ on scene recall.



Elements of the PRO Series **Recall Scope** screens

<i>Item</i>	<i>Element</i>	<i>Description</i>
1	SINGLE button	Scope function button for selecting single parameter sections on the scope screen.
2	BY CHANNEL TYPE button	Scope function button for selecting the same parameter section in all channels of a single type on the scope screen.
3	INDV. CHANNEL button	Scope function button for selecting all of the parameter sections of a single channel on the scope screen.
4	CONSOLE WIDE button	Scope function button for selecting all of the parameter sections of every channel on the scope screen.
5	ALL button	Scope function button that selects all of the parameter sections on the scope screen, that is, for every channel, assignable effect and internal GEQ.
6	NONE button	Scope function button that deselects all selected parameters sections on the scope screen.
7	STORE PRESET button	See Chapter 24 "User Libraries (Presets)" on page 235.
8	LOAD PRESET button	See Chapter 24 "User Libraries (Presets)" on page 235.
9	Key section	Shows what each parameter section symbol represents.
10	Rack units	Area for the assignable effects and GEQs.
11	Output channels	Area for the auxes, matrices and masters.
12	Input channels and groups	Area for the inputs, returns and VCAs.

The **Recall Scope** screen has a section for each of the following.

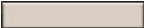
<i>Description</i>	Input Channels	Aux Returns (returns)	Aux Sends (auxes)	Matrix (matrices)	Masters	Variable Control Associations (VCA and POP groups)	Assignable Effects (internal effects) and Graphic EQs	<i>Symbol</i>
Routing	Yes	Yes	No	No	No	No	N/A	
All	Yes	Yes	Yes	Yes	Yes	Yes	N/A	
Mic Amp	Yes	Yes	No	No	No	No	N/A	
EQ	Yes	Yes	Yes	Yes	Yes	No	N/A	
Dyn	Yes	No	Yes	Yes	Yes	No	N/A	
Busses	Yes	Yes	Yes	No	Yes	No	N/A	
Mute	Yes	Yes	Yes	Yes	Yes	Yes	N/A	
Fader	Yes	Yes	Yes	Yes	Yes	Yes	N/A	
Assignable Effect/Graphic EQ	N/A	N/A	N/A	N/A	N/A	N/A	Yes	

>> To open the Recall Scope screen

At either GUI screen, choose **home ▶ Automation ▶ Recall Scope**.

Selecting scope parameter sections

The scope function buttons provide a number of ways of selecting/deselecting scope parameters, such as singly, by channel type, all on the control centre etc.

When a parameter is selected, its background changes from blue  to green .

Selection is cumulative, so you can combine any of the selection/deselection functions until all the desired parameter sections have been selected. When you have finished the selection process, just go to the next screen you require; you don't have to save your selection, as it remains stored in the current condition until you alter it again.

The "Assignable Effects" panel lets you choose which effects are 'out of scene' on scene recall.

For details of the parameters affected by scope, see Appendix K "Parameters Affected By Scope" on page 421.

>> To select a single parameter section

- 1 Click **SINGLE**.
- 2 Click the desired parameter section.

In some cases more than one parameter section may be selected. This may occur if:

- The parameter section belongs to a channel that is stereo linked. The equivalent parameter section of the other paired channel will also be selected.
- Other channels are patched to the same source as the channel in which you are making your selection. This only applies to the **All** and **Mic Amp** parameter sections.

>> To select a parameter section in all channels of a single type

- 1 Click **BY CHANNEL TYPE**.
- 2 Click the desired parameter section in any channel of the desired type. For example, click the routing parameter section in any of the input channels. The routing parameter section on all input channels will be selected (as shown right).

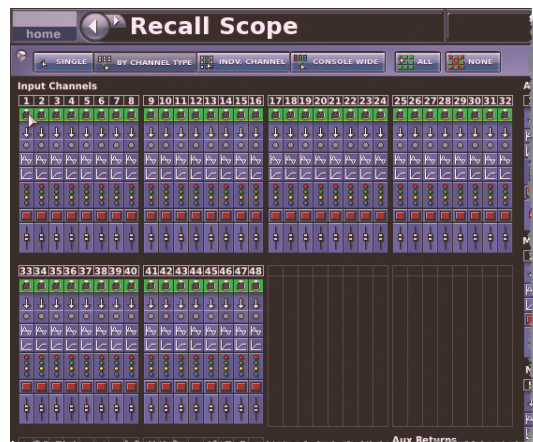
**>> To select all of the parameters of a single channel**

- 1 Click **INDV. CHANNEL**.
- 2 Click any parameter section in the desired channel. For example, click the **All** parameter of input channel 5; all the parameter sections in channel 5 are selected (as shown right).

If the channel is stereo linked, all of the parameter sections in its paired channel will also be selected.

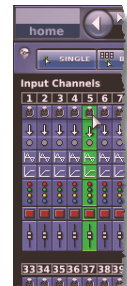

>> To select a single parameter section console wide

- 1 Click **CONSOLE WIDE**.
- 2 In any channel, click the desired parameter section. For example, clicking the fader parameter of input channel 1 selects the fader parameter of every channel.

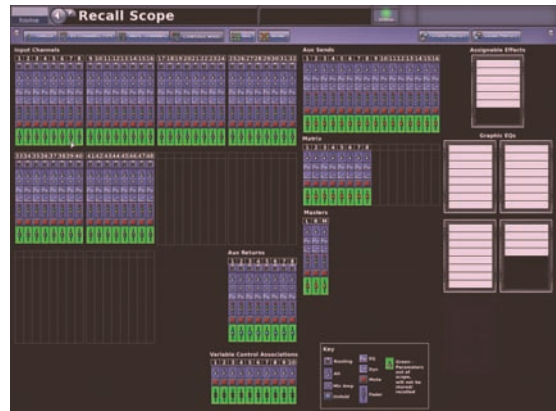

>> To select every parameter section on the console

Click **ALL**. Every parameter section on the **Recall Scope** screen is selected (as shown right).

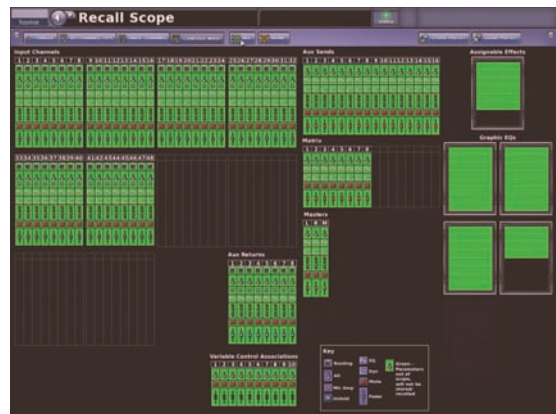

>> To deselect a parameter section(s)

Follow the procedures for selecting parameters, but only click ones that are already selected.

Selecting bus parameters

As a channel's bus parameter section represents all of its available buses collectively, you can only select either all or none of its buses using the scope function buttons. However, by clicking the bus parameter section you can open its 'bus select' window, which lets you select any buses you want out of scene. In this window each aux/matrix bus is represented by an single icon, and only available buses are shown.

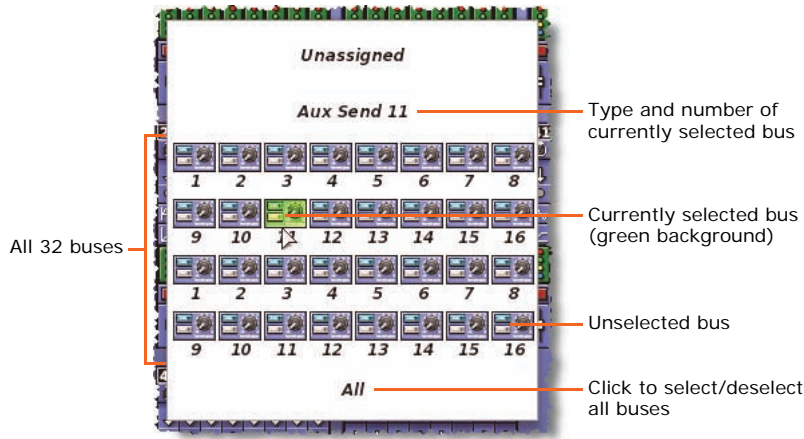

Typical 'bus select' window

The background colour of the bus parameter for each channel shows the selection status of its respective buses. There are three states, as shown in the following table.

Bus selection status	Symbol
None of the buses are selected	
One or more, but not all, of the buses are selected	
All of the buses are selected	

>> To select/deselect buses

In the 'bus select' window, do one of the following:

- To select/deselect a single bus, click on its icon.
- To select/deselect all buses, click **All**.

Saving scope parameters in a scene

Scope parameters have to be saved in a scene.

>> To save your selected parameters in a scene

- 1 Save the parameters you want into a scene (see “To create a new scene using the current settings” on page 115).
- 2 Select the desired recall scope parameters (see “Selecting scope parameter sections” on page 215).
- 3 Overwrite the scene by clicking the “Overwrite scene” option (see “To create a new scene using the current settings” on page 115).

Using store scope



Caution!

Although store scope is sometimes useful in very specific situations, it must always be used with care. This is because it is possible that control settings will not be stored at all and will consequently be lost. Therefore, it is much safer to use recall store and always store everything.

Please use store scope with great care and observe the **Caution** above. All of the methods of the recall scope operation, as detailed in this chapter, apply equally to store scope.

Chapter 22: Events (Automation)

This chapter shows you how to use the events of PRO Series automation.

About events

There are four types of event — MIDI, GPIO, internal and crossfade — that you can have in a scene, and you can have any combination of each. You can choose whether the event is triggered on the PRO Series or on an external device.

For more information on the events and also how to create, edit and copy/paste an event, see “Additional control — managing events” on page 116.

MIDI

MIDI performs two functions on the PRO Series. It allows the PRO Series Control Centre to trigger external MIDI-equipped equipment on each scene change and it also allows external MIDI equipment to trigger a PRO Series Control Centre scene change.

MIDI output from the PRO Series Control Centre can include a globally-enabled outgoing message that contains the recalled scene number and is sent out for all recalled scenes. Also, up to eight messages with user-selectable content are stored per scene and sent out whenever the scene is recalled.

MIDI input can be globally set up to cause scenes to be recalled when specific incoming MIDI messages are encountered.

GPIO

The general purpose input and output (GPIO) on the PRO Series is used to control or respond to various devices. You can use GPIO inputs to control PRO Series parameters from an external device, for example, you can use an external switch to switch the PRO Series Control Centre's talkback on/off or you can use an external switch or joystick to control the PRO Series Control Centre's parameters. You can also use the PRO Series Control Centre's keys and faders to send control signals to an external device.

Internal

You can create an event on the PRO Series without using an external device; this type of event is called an “internal” event. This means that an event is triggered and carried out entirely on the control centre.

Crossfades

For information on crossfades, see Chapter 23 “Crossfades (Automation)” on page 227.

Global scene

You can include an event(s) in every scene. (see “Global events” on page 233).

Connecting up the MIDI/GPIO equipment

The PRO Series has a set of MIDI sockets on the rear panel for connecting MIDI equipment (see “MIDI section” on page 268). There is also an equivalent set on the rear panel of the I/O boxes.

GPIO connections for the PRO Series are via the rear panel of the DL351 Modular I/O and DL451 Modular I/O. The PRO Series Control Centre doesn't have any GPIO connections.

About the Edit Event window

You can edit the parameters of an event in the **Edit Event** window and even change its name.

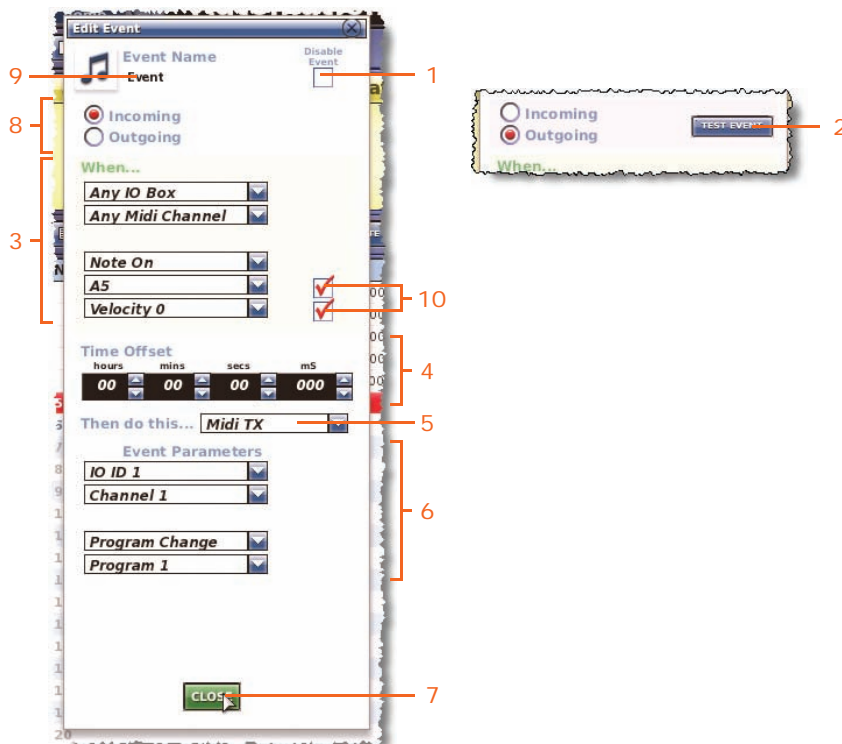

Figure 25: **Edit Event** window

Item	Element	Function
1	Disable Event tick box	For choosing whether the event is missed out (skipped) during a rehearsal.
2	TEST EVENT button	For executing the selected outgoing MIDI or GPIO event using the current event parameters. (Outgoing events only.)
3	When... section	For selecting the parameters that trigger the event.
4	Time Offset section	For setting the period of time that the event happens after it has been triggered. Zero = no offset.
5	Then do this... section	For choosing the type of event that you want.

<i>Item</i>	<i>Element</i>	<i>Function</i>
6	Event Parameters section	See the “Programming events” on page 223.
7	CLOSE button	Closes the Edit Event window.
8	Incoming/outgoing selection section	Selects whether the event is triggered on the PRO Series Control Centre itself or on an external device.
9	Text field	Displays the user-configured event name. You can edit the event name in this text field, which will then be displayed in the Name column of the scene cue list (see “Scene cue list” on page 203).
10	Enable Midi Byte 1 and 2 tick boxes	For selecting the parameters in the drop-down list to the left of each tick box. These give you more-specific parameters to choose from.

>> To open/close the Edit Event window

For details of how to open the **Edit Event** window, see “To edit an event” on page 116. To close the window, click **CLOSE**.

Programming events

Each type of event is programmed in a similar way, regardless of whether it is an incoming/outgoing MIDI or GPIO event, or an internal event. However, the options in the **Edit Event** window may vary depending on the chosen event.

>> To program an event

- 1 Open the **Edit Event** window (see “To edit an event” on page 116).
- 2 In the **Event Name** section, type in the event name. If you want to skip this event during a rehearsal, select the **Disable Event** option.
- 3 To select whether the event occurs on the PRO Series or an external device, click **Incoming** or **Outgoing**, respectively. (This is not applicable to internal events.)
- 4 Select the desired parameters in the **When...**, **Then do this...** and **Event Parameters** sections. To help you, refer to Table 14 “Outgoing event options” on page 224, Table 15 “Incoming event options” on page 224 and Table 16 “Description of all event option parameters” on page 225.
- 5 If you want to incorporate a time delay between the event being triggered and the event itself, select a time in the **Time Offset** section (click the up/down spin buttons).
- 6 Click **CLOSE**.

Table 14: Outgoing event options

<i>When ...</i>	<i>Then do this...</i>	<i>Event Parameters (from top list downwards)</i>			
<i>Scene Exit, Scene Recall, Scene Entry And Recall, Scene Entry And Exit, Scene Entry, Exit And Recall</i>	<i>Midi TX</i>	<i>IO ID1 to IO ID 17, FOH MIDI PORT</i>	<i>Channel 1 to Channel 16</i>	<i>Program Change, Control Change, Pressure, Aftertouch, Note On, Note Off</i>	<i>Program 1 to Program 128</i>
	<i>GPIO TX</i>	<i>IO ID1 to IO ID 17, FOH MIDI PORT</i>	<i>Static Low, Static High</i>	<i>Closure 1 to Closure 8</i>	N/A
	<i>Last</i>	N/A	N/A	N/A	N/A
	<i>Next</i>	N/A	N/A	N/A	N/A
	<i>Now</i>	N/A	N/A	N/A	N/A
	<i>Jump</i>	List of scene titles	N/A	N/A	N/A
	<i>Notes Event</i>	Event Parameters section changes to a Notes window, where you can enter event notes			

Table 15: Incoming event options

<i>When ... (from top list downwards)</i>			<i>Then do this...</i>	<i>Event Parameters (from top list downwards)</i>			
<i>Any IO Box, IO ID1 to IO ID 17, FOH MIDI PORT</i>	<i>Any MIDI Channel, Channel 1 to Channel 16</i>	<i>Note Off, Note On, After- touch, Pressure, Control Change, Program Change, Pitch Wheel</i>	<i>Midi TX</i>	<i>IO ID1 to IO ID 17, FOH MIDI PORT</i>	<i>Channel 1 to Channel 16</i>	<i>Program Change, Control Change, Pressure, After- touch, Note On, Note Off</i>	<i>Program 1 to Program 128</i>
			<i>GPIO TX</i>	<i>IO ID1 to IO ID 17, FOH MIDI PORT</i>	<i>Static Low, Static High</i>	<i>Closure 1 to Closure 8</i>	N/A
			<i>Last</i>	N/A	N/A	N/A	N/A
			<i>Next</i>	N/A	N/A	N/A	N/A
			<i>Now</i>	N/A	N/A	N/A	N/A
			<i>Jump</i>	List of scene titles	N/A	N/A	N/A
			<i>Notes Event</i>	Event Parameters section changes to Notes window, where you can enter event notes			

Table 16: Description of all event option parameters

<i>Parameter</i>	<i>Description</i>
Aftertouch	<p>How hard a key is pressed after it has been touched, that is, it changes the pressure after the note has been hit. Typically, aftertouch is useful for adding tremolo or vibrato effects to a sound, just as a violin can add volume or pitch changes to a sustained note using finger vibrato or additional bowing intensity.</p> <p>Parameters for Aftertouch are notes A0 to C7, with each having a possible pressure of between 0 and 127. You can also choose between Enable MIDI Byte 1 and Enable MIDI Byte 2.</p>
Any IO Box	The trigger can be on any IO port of any IO box.
Any MIDI Channel	Any of the MIDI channels.
Channel <i>n</i>	One of the 16 MIDI channels.
Closure <i>n</i>	Provides a contact closure that can be programmed to open or close in response to a MIDI event.
Control Change	<p>Select the control changes that can be applied to a note in progress. For example, by altering the volume (not velocity) or adding sustain to a note (holding it for longer).</p> <p>Parameters are All Notes Off and Reset All. You can also choose between Enable MIDI Byte 1 and Enable MIDI Byte 2.</p>
FOH MIDI PORT	The trigger is via the MIDI port of the FOH PRO Series Control Centre.
GPIO TX	Selects a GPIO event.
IO ID<i>n</i>	The trigger is via a specific IO port.
Jump	Opens a specified scene on the PRO Series.
Last	Opens the last (previous) scene on the PRO Series. This scene is the one that would be opened if you pressed the last button.
MIDI TX	Selects a MIDI event.
Next	Opens the next scene on the PRO Series. This scene is the one that would be opened if you pressed the next button.
Now	Opens the 'now' scene on the PRO Series. This scene is the one that would be opened if you pressed the now button.
Note Off	<p>Informs the instrument to stop playing a note at a specified pitch and velocity.</p> <p>Parameters for Note Off are notes A0 to C7, with each having a possible velocity of between 0 and 127. You can also choose between Enable MIDI Byte 1 and Enable MIDI Byte 2.</p>
Note On	<p>Informs the instrument to start playing a note at a specified pitch and velocity.</p> <p>Parameters for Note On are notes A0 to C7, with each having a possible velocity of between 0 and 127. You can also choose between Enable MIDI Byte 1 and Enable MIDI Byte 2.</p>

<i>Parameter</i>	<i>Description</i>
Notes Event	Using this option, you can display notes that may useful at a certain point in the scene.
Pitch Wheel	Use the pitch wheel to trigger the event. The pitch wheel is a wheel type device, normally found to the left of a synthesizer keyboard, that manipulates the pitch of a played note(s).
Pressure	Pressure applied to the key that is being pressed. This affects, for example, the vibrato of the note being played. Parameters are between 0 and 127. You can also choose between Enable MIDI Byte 1 and Enable MIDI Byte 2 .
Program <i>n</i>	One of the 128 programs.
Program Change	Changes the device to a particular patch/voice/preset etc. Parameters are 0 to 127. You can also choose between Enable MIDI Byte 1 and Enable MIDI Byte 2 .
Scene Entry	Triggers the event when a scene is opened.
Scene Exit	Triggers the event when a scene is closed.
Scene Recall	Triggers the event when the 'now' scene is reloaded (but not jogged to).
Scene Entry And Exit	Triggers the event when a scene is opened or closed.
Scene Entry And Recall	Triggers the event when a scene is opened or the 'now' scene is reloaded (but not jogged to).
Scene Entry, Exit And Recall	Triggers the event when a scene is opened, closed or the 'now' scene is reloaded (but not jogged to).
Static High	External device is closed/switched off.
Static Low	External device is opened/switched on.

Chapter 23: Crossfades (Automation)

This chapter shows you how to use crossfades.

Crossfades are events that are triggered using the standard event mechanism, and are managed via the **Automation** screen. A crossfade event is managed in a similar way to any other event, such as GPIO and MIDI, and is detailed later on in this section.

A crossfade event is a trigger to change the value of a control — most often but not always a fader — between two levels, that of the current control position and that of the position in another scene, over time. If the level in the next scene is higher than the current level, the crossfade uses the 'fade up' time; if it is lower, it uses the 'fade down' time.

About the crossfade Edit Event window

You can edit the parameters of a crossfade event in the **Edit Event** window.

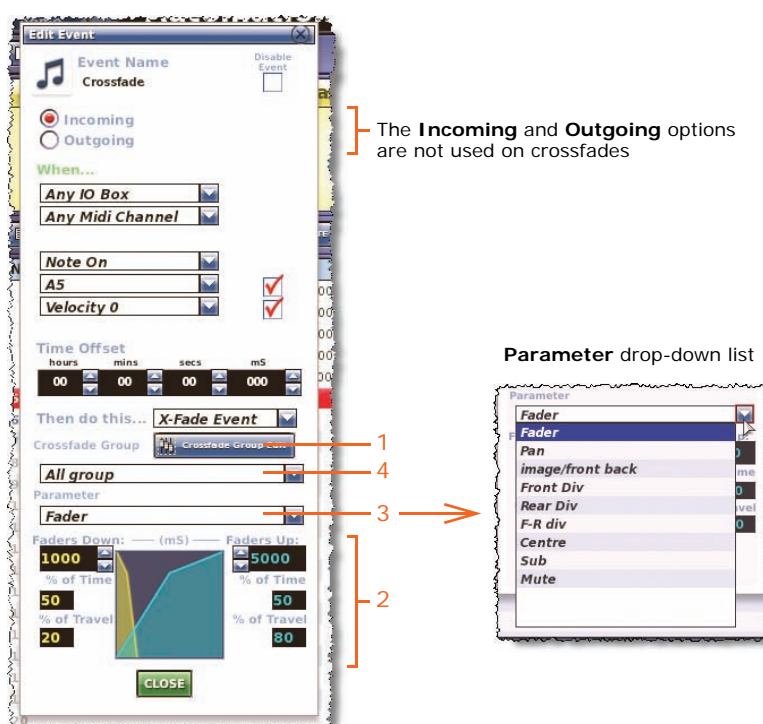

Crossfade **Edit Event** window (for details of the Edit Event window elements that are common to each event type, see Figure 25 "Edit Event window" on page 222)

Item	Element	Description
1	Crossfade Group Edit button	Opens the Crossfade Groups screen (see "Crossfade groups" on page 231).
2	Crossfade set up section	See "Crossfade set up section in the Edit Event window" on page 229.

Item	Element	Description
3	Parameter drop-down list	For choosing the level control that you want the crossfade to operate on (see “About the crossfade parameters” on page 228).
4	Crossfade Group drop-down list	Contains all of the available user-configured crossfade groups. Also includes the default example group that contains all possible crossfade sources.

About the crossfade parameters

The following diagram shows the PRO Series configured for 5.1 surround mode, which utilises each available parameter option. The presence of the **divergence**, **centre level** and **LFE level** sections are dependent on the currently selected surround mode.

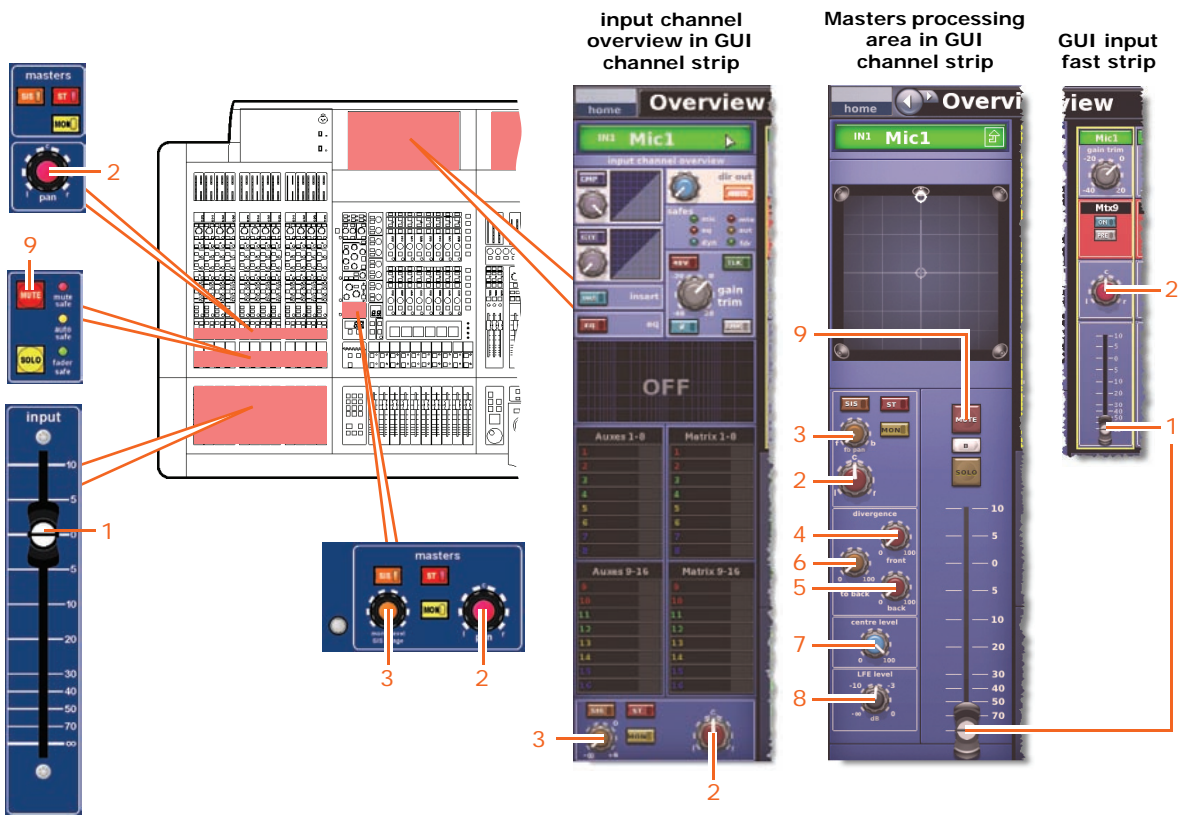

Item	Control	Parameter option
1	Fader	Fader
2	pan control knob	Pan
3	mono level/SIS image/[fb pan] control knob	image/front back
4	front control knob	Front Div
5	back control knob	Rear Div
6	front to back control knob	F-R div
7	centre level control knob	Centre

Item	Control	Parameter option
8	LFE level control knob	Sub
9	MUTE switch	Mute

Using a crossfade mute

The **Mute** option of the **Parameters** list lets you initiate a mute at the end of a crossfade down operation. For example, if you set a crossfade of two seconds, the mute will turn on after this time has expired (provided it was off). If the crossfade is a 'crossfade up', the mute will turn off during the crossfade up time (provided it was on).

Crossfade set up section in the Edit Event window

The crossfade set up section (bottom of the **Edit Event** window) is where you set up how the crossfade operates. Here you can set up the duration of the crossfade and the rate at which it occurs. You can configure two crossfade rates per crossfade or keep its rate constant throughout.

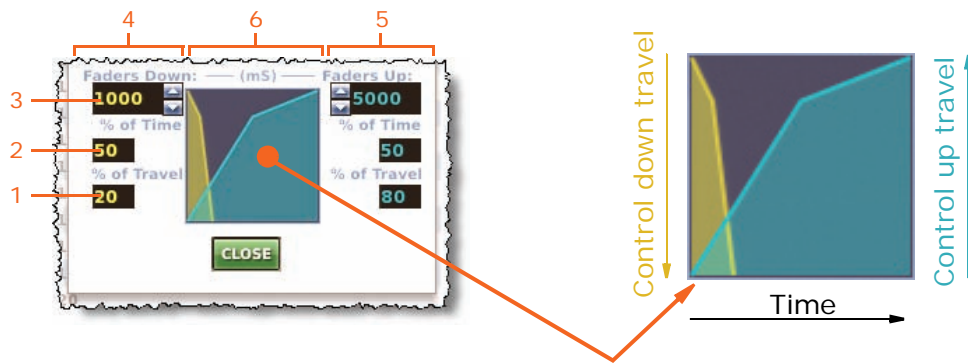

Figure 26: Crossfade set up section

Item	Element	Function
1	% of Travel number field	Sets the initial travel distance of the control as a percentage of the total distance of travel.
2	% of Time number field	Sets the time for the initial travel of the control as a percentage of the overall time.
3	Faders Down field	Sets the time taken for the total travel (milliseconds) of the control for a 'fader down' (or whichever control is used) crossfade event. For the Faders Up field, this sets the time taken for the total travel (milliseconds) of the control for a 'fader up' crossfade event.
4	Faders down section	For setting the crossfade down parameters.
5	Faders up section	For setting the crossfade up parameters.
6	Graph	Up/down crossfade graph.

>> To quickly adjust the time and travel of the faders up/down

You can quickly adjust the **% of Time** and **% of Travel** parameters by dragging the graph. Click anywhere on the line of the graph in the **Edit Event** window and drag to where the parameters are as desired. Clicking while pressing the left button adjusts the up travel, and doing the same with the right button adjusts the down travel.

>> To create a crossfade event

- 1 Open the **Edit Event** window.
- 2 If you want to disable this event, select the **Disable Event** option.
- 3 In the **When...** section, select the parameters that will trigger the event.
- 4 If you want to incorporate a time offset delay between the event being triggered and the start of the event, set a time in the **Time Offset** section.
- 5 In the **Then do this...** drop-down list, select the **X-Fade Event** option.
- 6 Do one of the following:
 - Select a crossfade group from the **Crossfade Group** drop-down list.
 - Create a new crossfade group. Click the **Crossfade Group Edit** button to open the **Crossfade Groups** screen and then follow the instructions in “Crossfade groups” on page 231.
- 7 In the **Parameters** section, select the level control on which you want the crossfade event to occur (see “Programming events” on page 223). For example, a fader.
- 8 In the crossfade set up section (see Figure 26 “Crossfade set up section” on page A-229), set up the crossfade parameters, such as time, % of travel etc.
- 9 Click **CLOSE**.

To set up a crossfade to have a constant rate across its full travel, set both the **% of Time** and **% of Travel** fields to 50%.

How a crossfade operates

When the crossfade event is triggered, the time offset (if configured) will start.

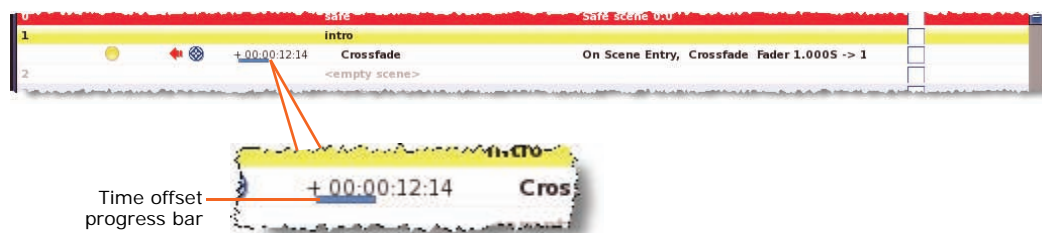

In the cue list, a blue status bar in a crossfade event will show the progress of a time offset

After the time offset has finished, the crossfade will start; this will be either a down or up crossfade, depending on the current control level. During the crossfade, the control level will alter at the configured rate, shown on both the control surface and GUI. Progress is shown in real time on the **Automation** screen.

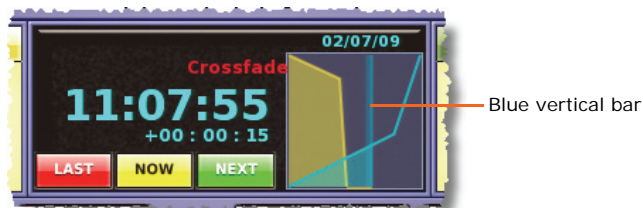

Typical crossfade graph in the Automation screen. The blue vertical bar will travel from left to right according to the time elapsed and at the configured crossfade rate.

Note: The graph display shows the current longest crossfade in progress. So, if a delayed crossfade starts during the current one, and it is longer than the current one, the graph will change to show the new crossfade.

You can manually override the crossfade using the controls in the automation section of the output bay (see “Manually controlling a crossfade” on page 234).

Crossfade groups

Crossfade groups let you choose which channels/buses/groups will contain the crossfade. These groups are managed at the GUI’s **Crossfade Groups** screen.

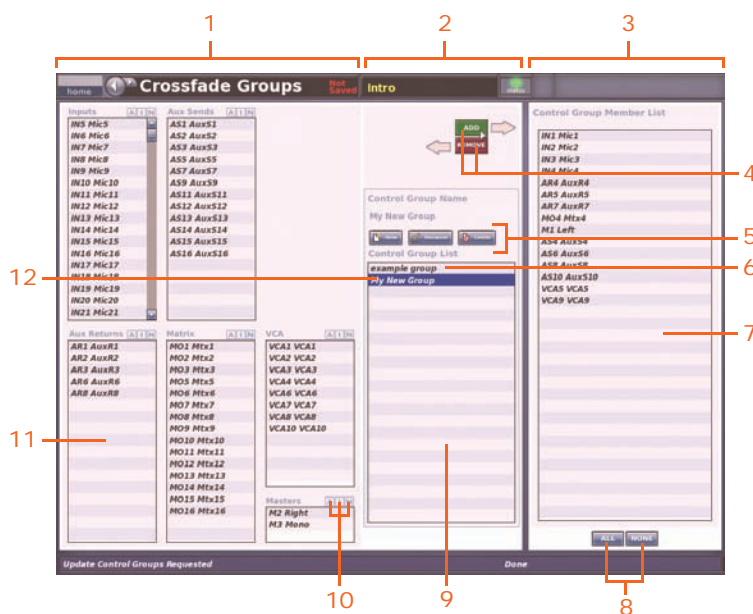

Crossfade Groups screen

Item	Description
1	Crossfade control group member source panel. Contains panels of channels, buses and groups from where you select the sources for your crossfade group.
2	Crossfade group management section, where you can create new crossfade groups or delete existing ones, add/remove members to/from the currently selected group, and select the desired group from the Control Group List .
3	Crossfade group member panel.

<i>Item</i>	<i>Description</i>
4	ADD and REMOVE buttons. These buttons add or remove the currently selected members to or from the Control Group Member List , respectively.
5	New , Rename and Delete buttons. These buttons let you create, rename or delete crossfade control groups, respectively.
6	Default crossfade control group. This group, called "example group", contains all of the channels, buses and groups as members.
7	Control Group Member List , which shows the current members of the selected crossfade control group.
8	ALL and NONE buttons. These buttons select all or none of the members in the Control Group Member List , respectively.
9	Control Group List , which shows the existing crossfade control groups.
10	A , I and N buttons. Each section in the crossfade source panel has a set of these buttons, which select all members in the list, invert the current list selection or deselect all members in the list, respectively.
11	A panel containing a list of channels, buses or groups available for crossfade group membership.
12	Name of the currently selected crossfade control group, as indicated by the background highlight.

>> To open the Crossfade Groups screen

At the GUI menu's **Automation** screen, click **Crossfade Group Edit**.

>> To create a new crossfade group

- 1 At the **Crossfade Group** screen, click **New**.
- 2 In the **Enter new control group name:** prompt window, type in your chosen name for the new crossfade group.
- 3 Click **OK**. The new group will appear in the **Control Group List**. By default, your new group will contain "IN1Mic1" as a member, as shown in the **Control Group Member List**.

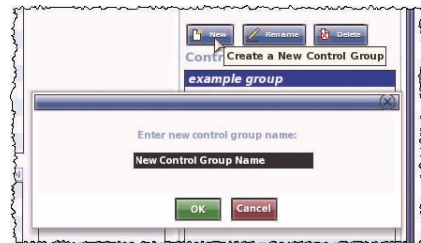

>> To edit a crossfade group

- 1 In the **Crossfade Group List** panel, select the crossfade group you want to edit.
- 2 Do one of the following:
 - To add members to the group, select the members from the lists of inputs, auxes, returns, matrices, masters and groups at the left of the screen and then click **ADD**. The selected items will be moved to the **Control Group Member List**.
 - To remove members from the group, select the members in the **Control Group Member List** that you want to remove and then click **REMOVE**. The selected items will be moved back to their respective panels in the left of the **Crossfade Group** screen.

If you want, you can edit the "example group" crossfade control group.

>> To rename a crossfade group

- 1 In the **Crossfade Group List** panel, select the crossfade group you want to rename.
- 2 In the **Rename control group as:** prompt window, type in the new name for the crossfade group.
- 3 Click **OK**. The new name will appear in the **Control Group List**.



If you want, you can rename the “example group” crossfade control group.

>> To delete a crossfade group

In the **Crossfade Group List** panel, select the crossfade group you want to delete and then click **Delete**.

You cannot delete the “example group” crossfade control group.

Global events

The **GLOBAL** scene, at the top of the cue list in the **Automation** screen, lets you have the same crossfade(s) in every scene. However, any scene-based crossfade(s) will override the global one(s) if both are present.

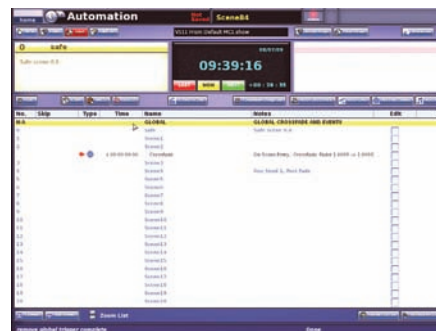

>> To set up a global crossfade

Select the **GLOBAL CROSSFADE AND EVENTS** scene and do one of the following:

- Click **ADD CROSSFADE**.
- From the right-click menu, choose **Add ▸ Crossfade Event**. The crossfade will appear in the **GLOBAL CROSSFADE AND EVENTS** scene.



GLOBAL scene (highlighted in yellow) in the **Automation** screen

Manually controlling a crossfade

The controls in the **automation** section of the output bay let you manually override the crossfade, as described in the following table.

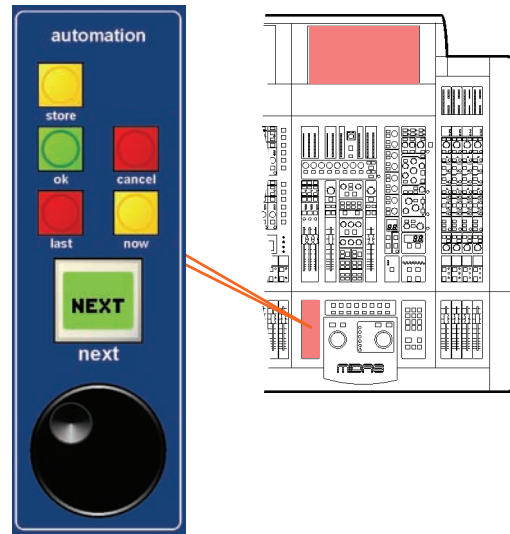

Control	Function during crossfade
cancel button	Pauses the crossfade. Pressing the cancel button again, while the crossfade is paused, cancels the crossfade. <i>Note: The level of the control on which the crossfade is operating will remain at the point at which it was paused. If you restart the crossfade the control will travel over the full crossfade period, that is, if you stop (rather than pause) a five-second crossfade at two seconds and restart it, it will take the control five seconds to move to the final position, and not three seconds.</i>
now button	Pressing this button while the crossfade is paused (by pressing the cancel button), continues the crossfade.
ok button	Jumps to the end of the crossfade, effectively cancelling the remaining time to the end of the crossfade.
Jogwheel	Rotate the jogwheel to slow down/speed up the rate of crossfade. The speed of rotation will determine the rate of crossfade. Rotating the jogwheel quickly in a clockwise direction will speed up the crossfade and rotating it an anti-clockwise direction slows it down.

Chapter 24: User Libraries (Presets)

User libraries is a GUI only feature that provides a method of handling presets. For more information on presets, including details of how to save and load a preset, see “User library (presets)” on page 119.

About the Preset Manager screen

Using the **Preset Manager** screen, you can create new user libraries, load existing ones or save the current one. You can create a new user library from scratch or save the current one under a new name. Similarly to show files, you can import libraries from external storage devices (USB memory sticks).

The **Preset Manager** screen also lets you delete presets from the currently loaded library.

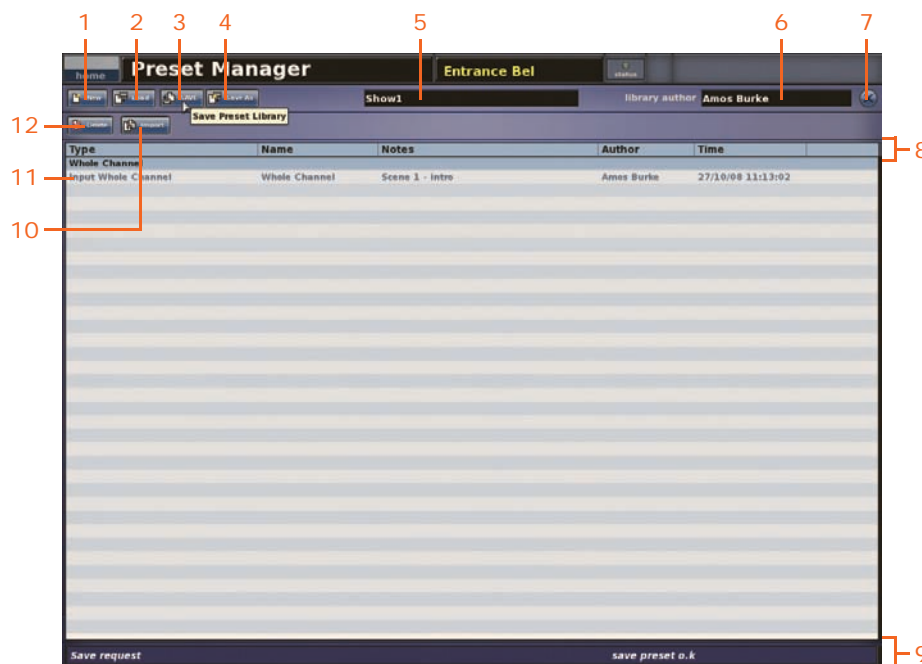

Typical **Preset Manager** screen

Item	Element	Description
1	New button	Lets you create a new preset library.
2	Load button	Lets you load an existing preset library.
3	SAVE button	Saves any unsaved changes that have been made to the currently loaded preset library.
4	Save As button	Lets you create a new preset library from the current one.
5	Show name text field	Displays the name of the currently loaded show file.

<i>Item</i>	<i>Element</i>	<i>Description</i>
6	library author text field	Shows the name of the person who created the preset library.
7	Close window button	Closes the Preset Manager screen.
8	Column headings	Preset information rows contain the following information: preset type (Type); user-entered name (Name); user-entered notes (Notes); preset creator (Author); and time and date the preset was created (Time).
9	Status bar	Displays operation status information.
10	Import button	Imports all presets from a preset library of your choice into the one currently loaded.
11	Preset information row	Contains preset details.
12	Delete button	Deletes the currently selected preset.

>> To open/close the Preset Manager screen

To open the **Preset Manager** screen, at the GUI choose **home ▶ Preset Manager**. To close it, Click **X** at the upper-right corner of screen.

Managing user libraries

The background of the **SAVE** button in the **Preset Manager** screen changes to red when changes have been made to the current user library, but they haven't been saved. We recommend that you save these changes regularly.

>> To create a new preset library

- 1 In the **Preset Manager** screen, click **New**.
- 2 In the "Enter new Library name:" message window (shown right), do the following:
 - Type in the name of the new preset library in the text field containing the text "Libraryname".
 - Type in your name in the text field containing the text "Author".



You can also replace an existing preset library. To do this, type in its exact name in the "Libraryname" text field and then click the **Overwrite existing?** box to tick it.

- 3 Click **OK**. A new **Preset Manager** screen will open.



*Don't forget that you can use the right-click **Cut**, **Copy** and **Paste** options when editing the text fields.*

>> To load a preset library

- 1 In the **Preset Manager** screen, click **Load**.
- 2 In the **Load File** window, click the preset library you want to load. Its name will appear in the "Load this file:" text field.
- 3 Click **OK**.

>> To save changes to the currently selected preset library

At the **Preset Manager** screen, click **SAVE**.

If the **SAVE** button is red (shown right), there are unsaved changes; this button changes back to blue after the library has been saved (updated).



>> To create a new preset library from the current one

- 1 In the **Preset Manager** screen, click **Save As**.
- 2 In the **Save File** window, type your chosen name for the new preset library in the "Save this file as:" text field.

You have the option to overwrite one of the existing preset libraries. Do this by clicking it in the **Save File** window and then ticking the **Overwrite existing?** option.

- 3 Click **OK**. The new preset library will be selected.

>> To import a preset library into the one currently selected

- 1 In the **Preset Manager** screen, click **Import**.
- 2 In the **Load File** window, click the preset library whose contents you want to import.
- 3 Click **OK**.

If the currently selected preset library has unsaved changes, the window message "The Preset Library has not been saved Do you wish to continue?" will appear. To continue importing, click **OK**.

If you want, you can save the changes by clicking **SAVE**.

Deleting presets from a user library

In addition to storing and loading presets (see "User library (presets)" on page 119), you can delete presets from a preset library.

>> To delete a preset from a user library

- 1 In the **Preset Manager** screen, click the preset you want to delete.
- 2 Click **Delete**.
- 3 In the "Are you sure you want to delete this preset?" message window, click **OK**.

Chapter 25: File Management

This chapter shows you how to import/export your show and preset files.

About the Files screen

The **Files** screen manages files on the control centre (**Control Surface** panel) and any removable storage device (**Removable Storage** panel) that is currently plugged into one of the USB ports (see “Front panel connections” on page 265). Each panel lists the files contained on its own storage media. The files can be imported/exported across the panels, and can also be copied, renamed or deleted within their own panel.

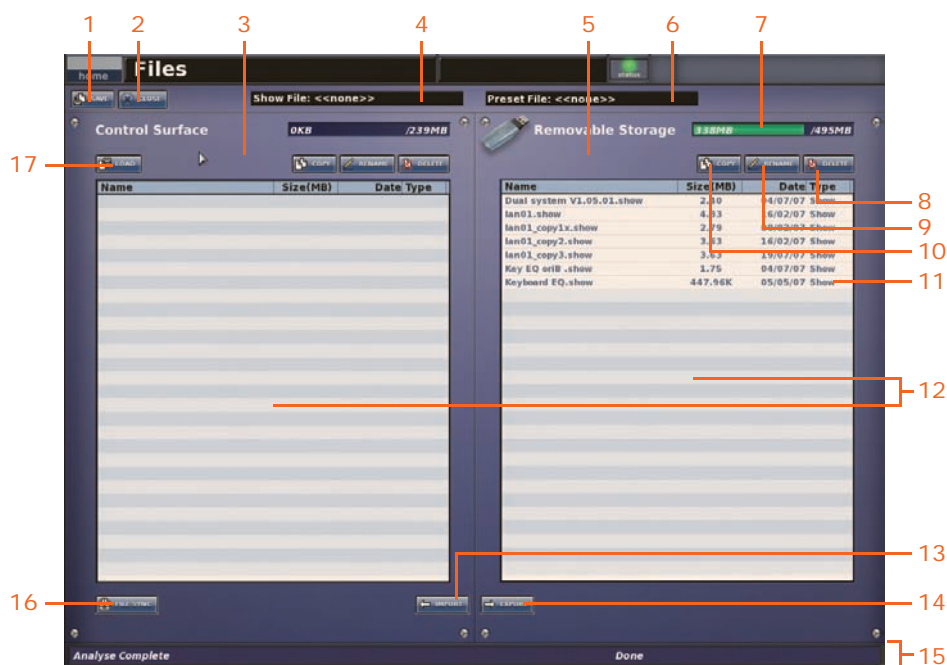

Typical **Files** screen

Item	Element	Description
1	SAVE button	Saves all currently loaded files. Turns red when there are changes to be saved.
2	CLOSE button	Unloads the currently loaded show/presets.
3	Control Surface panel	Contains elements pertaining to the control surface.
4	Show File text field	Title of show currently loaded, if any.
5	Removable Storage panel	Contains elements pertaining to the connected removable storage device (USB memory stick); it will be blank if no removable storage device is connected.
6	Preset File text field	Name of preset currently loaded, if any.

<i>Item</i>	<i>Element</i>	<i>Description</i>
7	Memory usage bar	The number on the right shows the total amount of storage space, or memory, available on the storage media of the control surface. The number on the left shows how much memory has been used, indicated by a green bar.
8	DELETE button	Deletes the selected file in its respective panel.
9	RENAME button	Lets you rename the selected file in its respective panel.
10	COPY button	Lets you copy the selected file into its respective panel.
11	File information row	Gives information on a single file, such as name, size, date of creation and type.
12	Lists of loaded files	Shows all the files on the PRO Series Control Centre and the removable storage device.
13	IMPORT button	Copies selected file(s) from the Removable Storage panel to the Control Surface panel, that is, from the removable storage media to the PRO Series Control Centre.
14	EXPORT button	Copies selected file(s) from the Control Surface panel to the Removable Storage panel, that is, from the PRO Series Control Centre to the removable storage media.
15	Status bar	Displays operation status information.
16	FILE SYNC button	Opens the Master Controller File Synchronisation window (see “About the Master Controller File Synchronisation window” on page 241). This button is normally blue, but turns red when the master controllers are not synchronised.
17	LOAD button	Loads the selected file in the Control Surface panel.

>> To open the Files screen

To open the **Files** screen, do one of the following:

- At a GUI screen, choose **home ▶ Files**.
- In the primary navigation zone, press the **automation/filing** screen access button twice.

About the Master Controller File Synchronisation window

The **Master Controller File Synchronisation** window manages the synchronisation between the two master controllers.

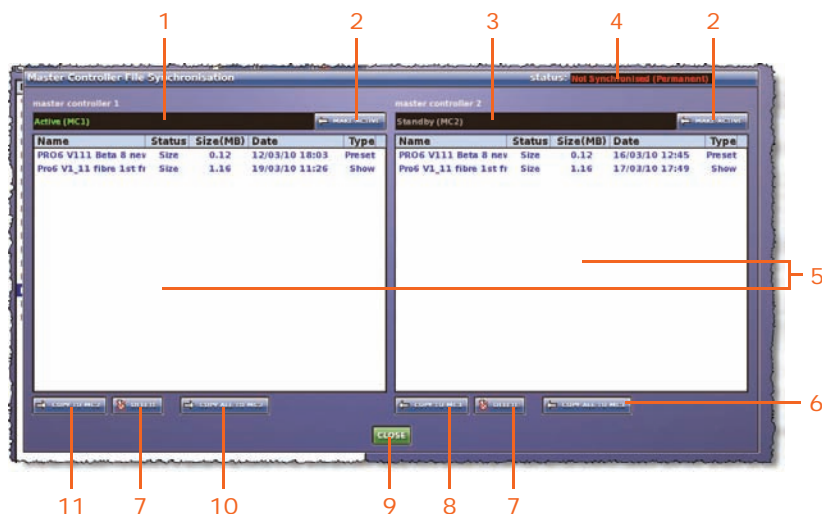

Master Controller File Synchronisation window

Item	Element	Description
1	master controller 1 status field	Shows whether this master controller is active or on standby.
2	MAKE ACTIVE button	Activates the respective master controller.
3	master controller 2 status field	Shows whether this master controller is active or on standby.
4	status field	Shows whether the master controllers are synchronised (green text) or not (red text).
5	Lists of master controller files	Lists the files loaded on each master controller and indicates whether they are synchronised (blue text) or not (red text).
6	COPY ALL TO MC1 button	Copies all files listed in the master controller 2 panel to master controller 1.
7	DELETE button	Deletes the selected file in its respective panel.
8	COPY TO MC1 button	Copies selected file in the master controller 2 panel to master controller 1.
9	CLOSE button	Closes this window.
10	COPY ALL TO MC2 button	Copies all files listed in the master controller 1 panel to master controller 2.
11	COPY TO MC2 button	Copies selected file in the master controller 1 panel to master controller 2.

Chapter 26: Using Other Devices With The PRO Series

This chapter explains how to use other external devices with the PRO Series.

Using multiple digital consoles



WARNING!

CHANGING THE SYNCHRONISATION CAN RESULT IN LOUD NOISES FROM THE SYSTEM. ALWAYS MUTE THE PA AT THE AMPLIFIER/SPEAKER BEFORE CHANGING THE SYNCHRONISATION SOURCE OR MASTER/SLAVE STATUS.

You can use a PRO Series Live Audio System together with one or more digital consoles, which can be other Midas digital consoles or indeed any digital console. For example, you can use two PRO Series Control Centres together in a dual FOH and MON system. To do this the digital consoles must be synchronised.

The synchronisation method can be via AES50, AES3 or wordclock. If you are connecting the digital consoles via DL431 Mic Splitters, you can synchronise using the splitters themselves via their AES50 connections.

Synchronising the consoles

Before you start, choose which Midas digital console you want as master.

For information on external AES50 synchronisation between two Midas digital consoles, see “External AES50 synchronisation” on page 124.

>> To configure system synchronisation at the consoles

- 1 Mute the PA at the amplifier/speaker. Refer to the **WARNING** at the beginning of this section.
- 2 On the master Midas digital console, configure it by choosing **home ▶ Preferences ▶ General** at the GUI and then clicking the “Master” option under the **Master/Slave Status** heading (shown right).
- 3 Configure a slave Midas digital console by choosing **home ▶ Preferences ▶ General** at the GUI and then selecting the following options:
 - Under the **Master/Slave Status** heading, click the “Slave” option.
 - Open the **Sync Source** drop-down list and select the desired synchronisation source you want, that is, “Word Clock” or “AES3”. If you want to sync using AES50, choose one of the eight AES50 ports as necessary, for example, “AES50 Port 2”.

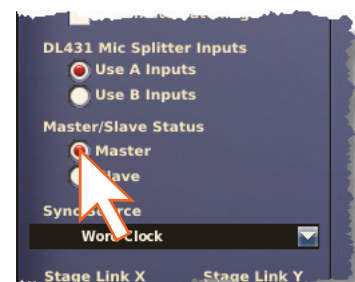

Repeat for any other Midas digital consoles. Configure any non-Midas digital consoles as appropriate.

Sharing DL431 Mic Splitter A and B inputs

If you are using two Midas digital consoles with a DL431 Mic Splitter, you must configure the consoles to use either the A or B inputs of the mic splitter. Although it doesn't matter which inputs each console uses, they can't use the same ones. Also, both consoles must be synchronised.

>> To configure two PRO Series Control Centres for use with DL431 Mic Splitters

In a dual FOH and MON system it may be easier and more convenient to always set the FOH control centre to master, and to use the mic splitter A inputs for FOH and the B inputs for MON. Also, although the sync method doesn't matter in this case, it is easier to sync the two consoles using the DL431 Mic Splitter, as described below.

- 1 Mute the PA at the amplifier/speaker. Refer to the **WARNING** at the beginning of this section.
- 2 Configure the **AES50 Sync** option of the DL431 Mic Splitter's main menu to **Cable Sync A**.
- 3 On the FOH control centre, configure it by choosing **home ▶ Preferences ▶ General** at the GUI and then selecting the following options:
 - Under the **DL431 Mic Splitter Inputs** heading, click the "Use A Inputs" option (shown right).
 - Under the **Master/Slave Status** heading, click the "Master" option.
- 4 On the MON control centre, configure the port for the DL431 Mic Splitter (see "Device set-up procedure" on page 93).
- 5 Configure the MON control centre by choosing **home ▶ Preferences ▶ General** at the GUI and then selecting the following options:
 - Under the **DL431 Mic Splitter Inputs** heading, click the "Use B Inputs" option.
 - Under the **Master/Slave Status** heading, click the "Slave" option.
 - Open the **Sync Source** drop-down list and select the port that you configured for the DL431 Mic Splitter in the previous step.



Using an external USB mouse

You can operate a GUI screen using an external USB mouse instead of its trackball (in the primary navigation zone). To use the USB mouse, plug it into one of the USB sockets (left of GUI screens, see "Saving your show files to a USB memory stick" on page 123). The top USB socket is for the left GUI screen and bottom one is for the GUI screen on the right. You can rest/operate the mouse in the primary navigation zone.

Using an external USB keyboard

You can use a USB keyboard with either GUI screen. Use one of the USB **keyboard** sockets at the front of the PRO Series Control Centre (see "Front panel connections" on page 265) as necessary.

Using an external monitor

You can use an external monitor for viewing what is displayed on either GUI screen. Use one of the VGA output sockets on the rear of the PRO Series Control Centre (see "External monitor section" on page 272).

Chapter 27: Changing The User Settings

This chapter shows you how to change the user settings of the PRO Series to suit your own preferences and the current working environment.

The user settings are changed via the GUI menu, mainly from the **Preferences** screen (shown right) and the 'Sheet' screens.

>> To open the Preferences screen

At a GUI screen, choose
home ▶ **Preferences** ▶ **General**.



Setting the meter preferences

The **Metering Preferences** section of the **Preferences** screen provides global parameter adjustment of all the meters on the control centre.

- **Peak/Hold Time** control knob, sets the time (in seconds) the peak LED stays on for, in the range 0 (no peak hold) to infinity (peak always on). This only affects the meters on the GUI. Click the **enable** tick box below to switch this on.
- **Meter Attack** control knob, adjusts the time it takes the meters to rise, in the range 0 (no delay) to 10 milliseconds. Select the **pre** option to switch the output channel meters to pre-fader.
- **Meter Delay** control knob, adjusts the meter delay time, in the range 0 to 0.5 seconds. For example, if the control centre is FOH, this function lets you synchronise the meters with what you are hearing. This is because the sound from the performers on the stage will take a certain amount of time to reach you, whereas the meters pick up that sound at source. Click the **enable** tick box below to switch on this function. You can adjust the meter delay by using the spin buttons underneath, which display the delay time in milliseconds (ms) and distance in metres (m).
- **Meter Decay** control knob, adjusts the time it takes the meters to fall, in the range 10 to 25 milliseconds.



Configuring a virtual soundcheck

The **Virtual Soundcheck** option of the **Preferences** screen lets you set the record and playback options for a virtual soundcheck.

- In the **Record** section:
 - **All Dir. Out Pre-processing** — switches all the direct outputs to pre-processing.
 - **Unmute all Dir. Out** — unmutes all direct outputs.
 - **Mute all Dir. Out** — mutes all direct outputs.
 - **Set All Dir. Out Gains to 0dB** — sets all direct output gains to 0dB.
- In the **Playback** section:
 - **Input Channel Source** — lets you select the input channel source as **Normal** or **Tape Return**.
 - **Enable all Tape Returns** — enables all tape returns.
 - **Disable all Tape Returns** — disables all tape returns.



Restoring the PRO Series defaults



Caution:

The **Restore Default Preferences** button will reset all console preferences, and must be used with great caution. To alert you of the drastic consequences of operating this button, a **WARNING** window appears.



Caution:

The **Restore Default Globals** button resets all console defaults, including patching and I/O set-up, and must be used with great caution. To alert you to the drastic consequences of operating this button, a **WARNING** window appears.

You can restore console defaults by using the options in the **Restore** section of the **Preferences** screen. However, these options must be used with care.

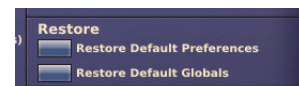

>> To reset console preferences to default

Open the **Preferences** screen and click **Restore Default Preferences**. Acknowledge the warning window (see **Cautions** above).

>> To reset all console settings to default

Open the **Preferences** screen and click **Restore Default Globals**. Acknowledge the warning window (see **Cautions** above).

Checking the PRO Series build information

This section, which is predominantly a service-only feature, shows the current build and host software versions of the PRO Series Live Audio Systems equipment.

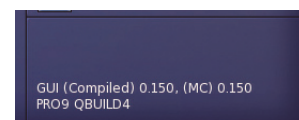

Setting the configuration preferences



WARNING!

CHANGING THE SYNCHRONISATION CAN RESULT IN LOUD NOISES FROM THE SYSTEM. ALWAYS MUTE THE PA AT THE AMPLIFIER/SPEAKER BEFORE CHANGING THE SYNCHRONISATION SOURCE OR MASTER/SLAVE STATUS.



Caution:

The Automate Patching option switches on per-scene automatic routing, and must be used with caution. To alert you to the drastic consequences of using this option, a WARNING window appears.

The **Configuration Preferences** section of the **Preferences** screen lets you configure the system as follows:

- **Effects and GEQs** — drop-down list from which you can select the desired combination of effects and GEQs (see Chapter 15 "Graphic Equaliser (GEQ)" on page 157).
- **Automate Patching** — ticking this option lets you change audio patching in automation (see "Using patching in automation" on page 208).
- **DL431 Mic Splitter Inputs** — if you are linking two PRO Series Control Centres (for example, for FOH and MON operation) this option lets you select the type of inputs (A or B) you want for this PRO Series Control Centre. The other PRO Series Control Centre must be set with the alternate option. For example, if you select **Use B Inputs** at this control centre, the other one will have to be set for **Use A Inputs**.
- **Master/Slave Status** — selects the synchronisation source of the PRO Series Control Centre's digital audio, which can be either internal or external. For configuration details when connecting two PRO Series Control Centre's, see "Using multiple digital consoles" on page 243.

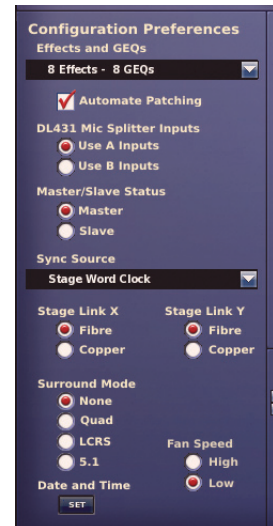

If you choose **Master** (internal), all system units must be configured for external sync source.

If you want an external sync source, choose **Slave**. Then, select the sync source from the **Sync Source** drop-down list (below). On the sync source itself, for example, a line I/O or mic splitter, configure its sync source as internal.

- **Sync Source** — drop-down list from which you can select the synchronisation source.
- **Stage Link X** and **Stage Link Y** — select the snake type for each network. **This must be done before operating the PRO Series Control Centre, otherwise it will not work.**
- **Surround Mode** — select the type of surround mode you want. Otherwise, select **None** for no surround mode.
- **Fan Speed** — select the speed of the internal cooling fan of the PRO Series Control Centre as **High** (fast) or **Low** (slow). If you are operating the PRO Series in a warm or hot environment, we recommend that you select the **High** option. If the noise of the fan operation is causing a problem, select the **Low** option.
- **Date and Time** — click the **SET** button to set the date and time (see "Setting the time and date" on page 252).

Changing the user interface preferences

The **User Interface Preferences** section of the **Preferences** screen lets you set some of the PRO Series Control Centre's operating parameters to suit your own preferences.

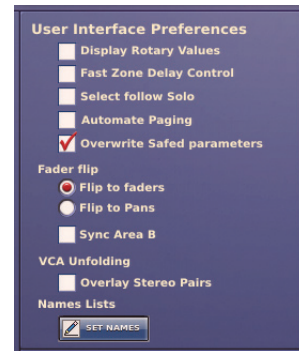

- **Display Rotary Values** — the current value of a control knob can be displayed as a numerical value on the GUI (see “Parameter values displayed on touch” on page 54).
- **Fast Zone Delay Control** — selecting this option means that you place the delay control for the inputs onto the surface controls. To do this you have to cycle the gain swap switch (see “Mic amp input gain (preliminary input processing)” on page 286) through digital gain, analogue gain and then delay. Without selecting this option, the inputs delay control is a GUI only feature.
- **Select follow Solo** — when you solo an aux or matrix output, the channel is automatically selected, thus bringing the output controls to the surface detail area. This option only works in fader flip mode.
- **Automate Paging** — select this option to store channel paging in automation. So that, on scene recall, the control surface (channels assigned to it) will revert to the state it was in when the scene was last saved. When unselected, scene recall does not affect channel paging.
- **Overwrite Safed parameters** — see “Overriding store scope” on page 207.
- **Fader flip:**
 - Choose between **Flip to faders** and **Flip to Pans** to control the currently selected mix bus using the faders or the pan control buttons, respectively, in the full input bay (see “Controlling the mix buses in flip mode” on page 48).
 - **Sync Area B** — when the PRO Series Control Centre is set up for two-man operation (see “Two-man operation” on page 122) and you are using fader flip, selecting this option will synchronise the mix bus selection across areas A and B, so that both areas operate on the same mix buses.
- **VCA Unfolding** — select **Overlay Stereo Pairs** to unfold only left channels of channel pairs when a VCA group is selected; use the **scroll by 1** navigation buttons to display any right channel you want.
- **Names Lists** — click the **SET NAMES** to open a window from which you can change the names in the input and output sheet lists (see “Changing the default input/output names” on page 251).

Changing the signal processing preferences

The **Signal Processing Preferences** section of the **Preferences** screen lets you set up your DSP preferences.

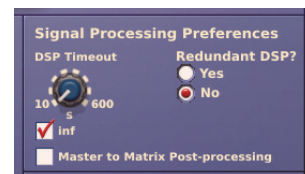

- **DSP Timeout** — control knob for adjusting the amount of time (between 10 and 600 seconds) the DSP engine will continue to run after an update is received from the control surface, before muting the audio.
- **inf** — tick box for selecting infinity, which will allow audio to continue indefinitely if power to the control surface is lost.
- **Master to Matrix Post-processing** — tick box for selecting whether the tap-off point is either a pre- or post-master channel processed signal that is sent to the matrix channels (see “Master to matrix post-processing option” on page 257), and determines whether the signal is sent without or with processing, respectively. This

is used in combination with the **Delay Compensation** section underneath (see “GUI Delay Compensation options” on page 254).

- **Redundant DSP?** — if you have a redundant DSP connected in the system, select **Yes**. Otherwise, select **No**.

Configuring the channels, groups and internal units

You can change the default name and colour of the input and output channels, groups, internal rack units and GEOs of the PRO Series Control Centre that appear on the control surface (LCD select buttons) and GUI. This is done via the ‘Sheet’ screen of each item, which is accessible via the GUI menu.

The procedure for configuring the VCA/POP groups is shown in “Configuring VCA/POP groups” on page 105, and this is principally the same for each of the above items.

Changing the default input/output names

You can change the names that appear in the lists on the **Input Sheet** and **Output Sheet**. These lists provide you with a number of default names from which you can choose when naming your inputs and outputs in the GUI menu.

>> To change the set names in the Input/Output Sheets

- 1 At the GUI, choose **home** ▶ **Preferences** ▶ **General**.
- 2 In the **Names Lists** section of **User Interface Preferences**, click **SET NAMES**. This opens the **Set Name Lists** window.
- 3 In the **Set Name Lists** window (shown right), click within the field containing the name you want to change. Type in the new name (see “Text editing” on page 57).
Repeat for any other names you want to change.
- 4 Click **CLOSE**.



Adjusting PRO Series illumination

The **Illumination** section of the **Preferences** screen lets you adjust the brightness and contrast of both GUI screens individually to suit the operating conditions. You can also adjust the brightness of the lightbar (under the hood) that illuminates the control surface, and the brightness of the LEDs (including meters) on the control surface.



>> To adjust the GUI screen brightness and contrast

- 1 At the desired GUI screen, choose **home** ▶ **Preferences** ▶ **General**.
- 2 In the **Illumination** section, do the following:
 - To increase/decrease GUI screen brightness, click the up/down **Screen Brightness** spin buttons.
 - To increase/decrease GUI screen contrast, click the up/down **Screen Contrast** spin buttons.

>> To adjust the brightness of the lightbar

To increase/decrease the brightness of the lightbar, click the up/down **Lightbar Brightness** spin buttons.

>> To adjust the brightness of the LEDs/meters

To increase/decrease the brightness of the solo LEDs, meter LEDs or the other LEDs on the control surface, use drag to adjust the appropriate control knob on the GUI (from full to off).

Setting the time and date

You can change the PRO Series Control Centre's time and date.

>> To set the time and date of the PRO Series

- 1 At a GUI screen, choose **home** ▶ **Preferences** ▶ **General**.
- 2 In the **Date and Time** section of **Configuration Preferences**, click **SET**. This will open a window containing **Time** and **Date** fields.

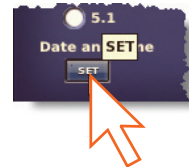

- 3 In the **Time** field, set the current time by typing the hour and minutes into the **Hour** and **Mins** fields, respectively. Make sure you enter the time correctly, according to the currently selected format.



If necessary, change the time display format by using the **Format** drop-down list.

- 4 In the **Date** field, set the date by typing in the current day, month and year in the appropriate fields.
- 5 Click **OK**.

Chapter 28: Delay Compensation (Latency)

A time delay is induced in a channel's signal by placing, for example, an insert or GEQ in its path. This delay affects system latency and can also produce undesirable audio effects. To overcome this the PRO Series incorporates a system of user-configurable delay compensation parameters. These are presented to the user in the form of button-selectable options on the GUI and can be switched on or off to suit the current application.

Insert compensation

If a channel insert is active, it takes a finite amount of time for the signal to be sent through an internal or external effect and returned to the channel. Therefore, with no insert compensation, channels with inserts assigned are delayed more than channels that don't have an insert assigned to them. If two correlated signals with different delays are mixed together, this can produce comb filtering.

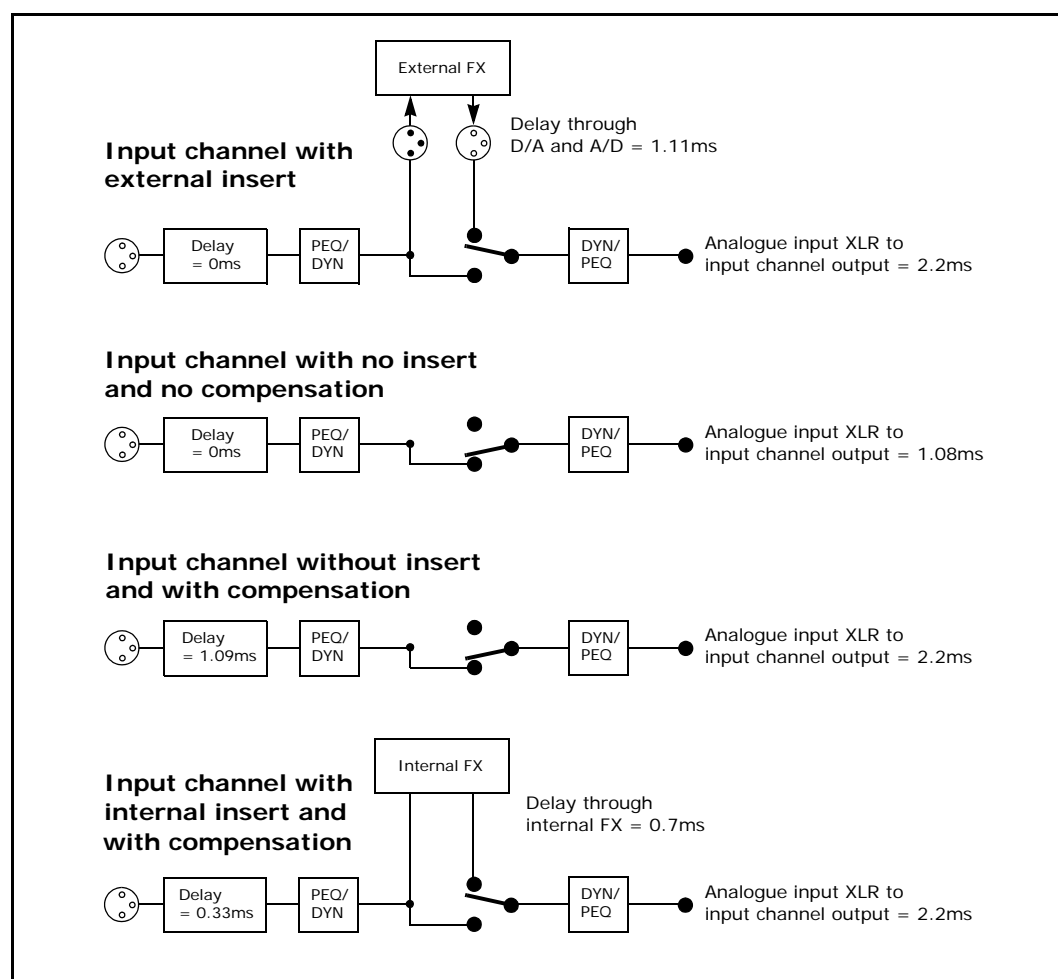

To avoid the comb filtering effect, the PRO Series insert compensation works by delaying all channels except the ones that have inserts assigned. In practice, the actual delay used for compensation depends on the type of insert (internal/external) and its location (stage/FOH). Each channel type or layer within the control centre, such as, input, aux, master or matrix, has its own parameter controlling the delay compensation for that layer. This provides the user with the maximum flexibility and allows the control centre to be configured for the lowest latency for a given application.

GEO compensation

Output bus channels have the ability to have a GEO inserted into them, which incurs an additional delay in their signal path. With GEO compensation active, a delay is inserted into the output buses, which is removed when a GEO becomes active. This ensures that all bus outputs of the same type are aligned, regardless of whether they use a GEO or not.

GUI Delay Compensation options

PRO Series delay compensation (latency) is configured in the **Delay Compensation** section of GUI menu's **Preferences** screen.

For a description of the delay compensation options and details of when best to use them, see Table 17 (below). In this table the **Description** column explains what happens when the delay compensation option is selected (switched on) and the **Latency (ms)** column shows the value that the overall system latency is increased by.

>> **To access the delay compensation options**

At the GUI, choose **home ▶ Preferences ▶ General**.

Table 17: Delay Compensation options

Section	Option	Description	Recommendations	Latency (ms)
Input Channels	Insert	Time-aligns the output of all input channels, regardless of whether or not they have an active insert. When this option is switched off, any input channels with inserts will be delayed relative to those input channels that do not have inserts.	If no inserts are used in the input channel layer, switch this option off to reduce the overall system latency. If there is an insert on any input channel, switch this option on.	1.11
Aux Sends	Monitor Mode (Align with Masters)	See "Monitor Mode (Align with Masters)" on page 256.	N/A	N/A

<i>Section</i>	<i>Option</i>	<i>Description</i>	<i>Recommendations</i>	<i>Latency (ms)</i>
Aux Sends	Insert	Compensates for inserts placed in aux buses. To do this it modifies the delay that sits between the input channel outputs and master/matrix channel inputs, so that signals fed from inputs to masters will line up with signals fed from inputs through auxes to masters.	<p>If there are no inserts on any aux channels, switch this option off to reduce overall system latency.</p> <p>If any aux channel has an insert, switch this option on.</p> <p>If the Monitor Mode (Align with Masters) option is selected, it is prudent to switch this option off.</p>	1.11
Aux Sends	Send-FX-Return	This option compensates the inputs to master and matrix paths for the signal path between an aux through an effect, and back through a return to the master and matrix channels.	<p>If no effects are used between the aux and return channels, switch this option off so that overall system latency will be reduced.</p> <p>If any effects are used between any auxes and returns, switch this option on.</p> <p>If the Monitor Mode (Align with Masters) option is selected, it is prudent to switch this option off.</p>	1.11
Aux Sends	Graphic EQ	This setting controls the delay compensation that aligns aux bus outputs for channels which <i>do</i> use GEQ with those that do not.	<p>If no aux buses use GEQ, switch this option off to reduce overall system latency.</p> <p>If any aux bus has a GEQ inserted, switch this option on to ensure all aux bus outputs are time-aligned.</p>	0.7
Master and Matrix	Insert	Time-aligns the output of all the master and matrix channels, regardless of whether or not they have an active insert. With this option switched off, the outputs of any master or matrix channels using inserts will be delayed relative to the equivalent channels not using them.	<p>If no inserts are used in the master/matrix channel layer, switch this option off to reduce overall system latency.</p> <p>If Inserts are used in any master/matrix channels, switch this option on.</p>	1.11
Master and Matrix	Graphic EQ	This option controls the delay compensation that aligns master and matrix bus outputs for channels using GEQ with those that do not.	<p>If no master or matrix buses are using GEQ, switch this option off to reduce overall system latency.</p> <p>If any master or matrix buses have a GEQ inserted, switch this option on to time-align all master and matrix bus outputs.</p>	0.7

Monitor Mode (Align with Masters)

The default control centre bus structure is organised such that inputs can be routed to masters and also simultaneously routed to masters and matrix channels via the aux (aux send) buses (Figure 28) or via the aux and return buses (Figure 27), while maintaining the same overall input to output latency in both paths.

This may not be the desired structure if aux (aux send) and matrix outputs are both being used for monitor mixes, where it is desirable for aux, masters and matrix outputs to be time-aligned with the minimum possible latency.

When this switch is on, the delay element that is used to delay the paths from input channels to master/matrix channels is removed. With all insert and GEQ delay compensation switched off, the latency between a system input XLR and a system output XLR being fed by an aux, master or matrix channel is 1.83ms (Figure 29).

In this mode, it is advisable to use the same GEQ and insert compensation settings for aux and master/matrix channels to maintain their identical output latency.

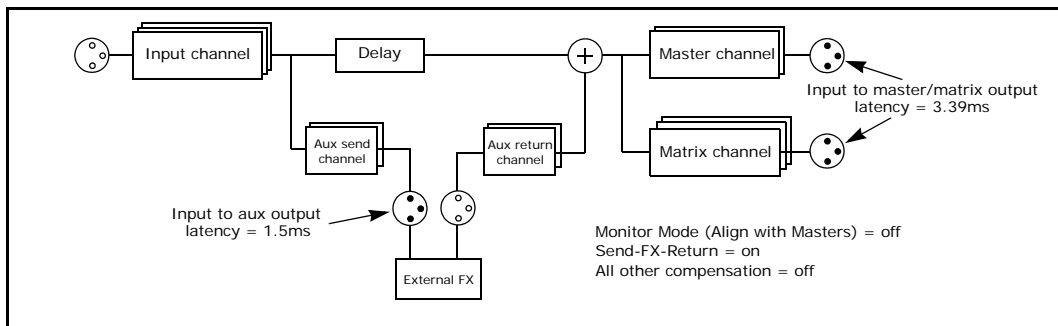

Figure 27: Routing via the aux send and return buses

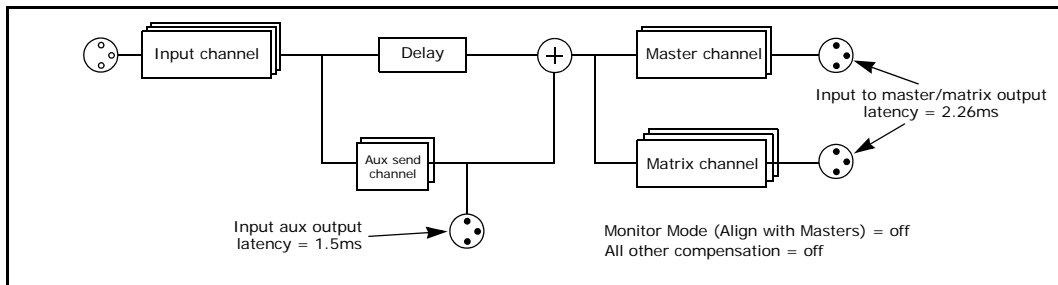

Figure 28: Routing via the aux send buses

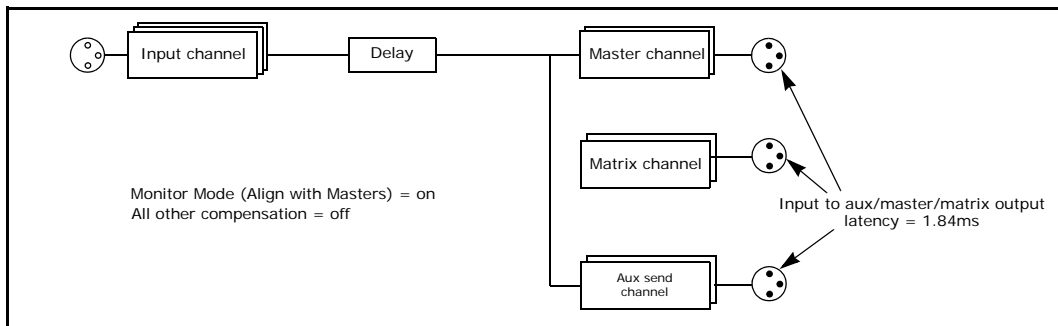

Figure 29: Latency for normal routing

Zones

The PRO Series system can be divided into conceptual ‘zones’, as follows:

- **System Input Zone:** DL251 Audio System I/O, DL351 Modular I/O, DL431 Mic Splitter or DL451 Modular I/O/AES3 inputs, which are normally routed to input channels. These inputs are *primary* system inputs and the control centre output latency is measured relative to these inputs.
- **Mix Zone:** Aux outputs, return inputs and master/matrix direct inputs, which can be freely patched to and from internal or external effects, while maintaining output signal alignment.
- **Output Zone:** System outputs, that is, master and matrix outputs when **Monitor Mode (Align with Masters)** option is switched off, or aux, master and matrix outputs when it is switched on.

Aux direct inputs are fixed to the System Input Zone, so that system inputs that are routed to an aux direct input will automatically line up with inputs routed to auxes via input channels.

Return inputs and master and matrix direct inputs can be configured to operate in either the System Input Zone (for example, as additional control centre inputs) or the Mix Zone (for example, as effect returns) and are configurable on a per channel basis.

Examples of patches using the Mix Zone that are all fully compensated when the **Send-FX-Return** delay compensation is switched on are:

- Aux -> Internal/External Effect -> Return
- Aux -> Internal/External Effect -> Master Direct Input
- Aux -> Internal/External Effect -> Matrix Direct Input

For all system inputs — including insert return points — the actual location of the input XLR is automatically compensated for, so an insert using I/O at the stage location will produce the same latency as an insert at FOH.

Input channel direct outputs are simply a copy of the input channel output or mic input signal, depending on the direct output mode for a particular channel. It is not possible to delay these signals to line up with the main system outputs or aux outputs, so patching from a direct output to an effect and back in to a return/master direct input etc. cannot be fully compensated for.

The input to direct output latency depends on the direct output mode and input channel insert delay compensation status according to the following table.

<i>Direct Output mode</i>	<i>Input channel insert compensation (ms)</i>	
	<i>Off</i>	<i>On</i>
Pre-processing	0.76	0.76
Post-processing	1.073	2.188

Master to matrix post-processing option

The signal path that feeds master bus signals onto matrix channels is fully compensated for, so that signals fed directly to matrix channels or indirectly to matrix channels via master channels will always line up at the outputs, as will signals sent only to masters or only to matrix channels.

You have a choice of tap-off point, so you can choose to send either a pre-master or post-master channel processed signal to the matrix channels. This is a global setting and affects all master -> matrix contributions (see Table 30 “Master and matrix tap-off points”).

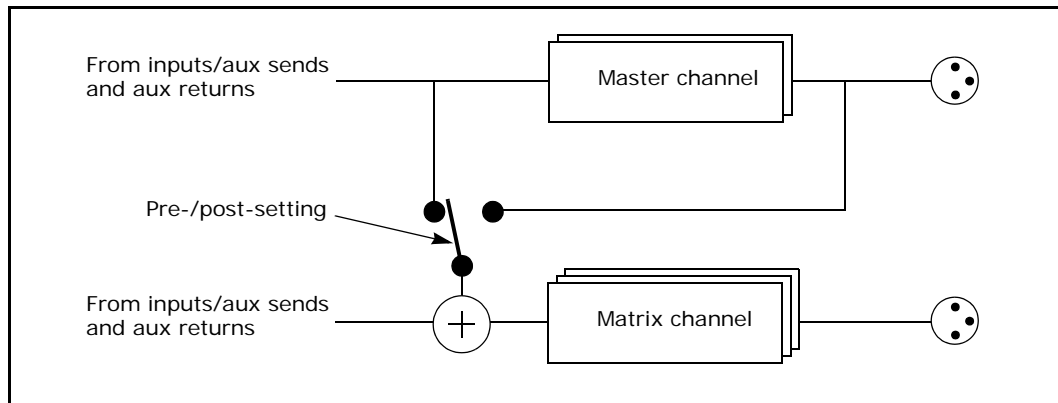

Figure 30: Master and matrix tap-off points

Sending pre-processed master bus signals to matrix channels reduces the overall system latency. If post-processed tap-off points are used, the system must compensate for both the latency of the matrix and master channels, and — if insert and GEQ compensation are both required on master and matrix channels — this can push the maximum system latency up to 10.1 ms. With no other insert or GEQ compensation switched on, using post-processed tap-off points produces a system latency of 2.44ms, as opposed to pre-processing tap-off points, which would produce a latency of 2.26ms. When **Monitor Mode (Align with Masters)** is switched on, these values are 1.83ms and 2.01ms, respectively.

Solo bus delay compensation

The following signal paths all have the same latencies for the various delay compensation preference settings shown below.

- XLR - IP - SOLO
- XLR - IP - AS - SOLO
- XLR - IP - MAST - SOLO
- XLR - IP - MTX - SOLO
- XLR - IP - MAST - MTX - SOLO
- XLR - AS DI - SOLO
- XLR - MAST DI (Input) - SOLO
- XLR - MTX DI (Input) - SOLO
- XLR - AR (Input) - SOLO

<i>Delay compensation preset</i>	<i>Latency (ms)</i>
FOH Mix	8.71
FOH Mix Low Latency	4.66
Monitor Mix	3.11
Monitor Mix Low Latency	2.41

Typical configurations

The following subsections contain actual examples of typical configurations to illustrate the effects of delay compensation. Please note the following:

- All XLRs are located at stage end, unless FOH is stated.
- INS can mean an internal effect or an external effect with analogue or AES3 I/O at either FOH or stage positions.
- Abbreviations are: IP = input channel; AS = aux (send) channel, AR = (aux) return channel; AR (Input) = (aux) return channel set to input mode; MAST = master channel; MTX = matrix channel; DI (Mix) = direct input set to Mix Time Zone (DI can be either pre- or post-); and DI (Input) direct input set to System Input Time Zone (DI can be either pre- or post-).

FOH mix setup

The following table shows the delay compensation settings for this mix.

<i>Option</i>	<i>On/off status</i>
Master to Matrix Post-processing	Off
Input Channels	
Insert	On
Aux Sends	
Monitor Mode (Align with Masters)	Off
Insert	On
Send-FX-Return	On
Graphic EQ	On
Master and Matrix	
Insert	On
Graphic EQ	On

The following signal path examples all measure the same latency of 780 samples at 96kHz = 8.125ms:

- FOH XLR – IP – MAST – XLR
- XLR – IP – MAST – XLR
- XLR – IP – MTX – XLR
- XLR – IP – AS – MAST – XLR
- XLR – IP – AS – INS – MAST – XLR
- XLR – IP (With INS) – AS (With INS) – INS – AR – MAST (With INS) – XLR
- XLR – IP (With INS) – AS (With INS + GEQ) – INS – AR – MAST (With INS + GEQ) – XLR
- XLR – IP – AS – INS – MAST DI (Mix)
- XLR – IP – AS – INS – MTX DI (Mix)
- XLR – MAST DI (Input)
- XLR – MTX DI (Input)
- XLR – AS DI – MAST – XLR
- XLR – AR (Input) – MAST – XLR
- XLR – AR (Input) – MTX – XLR
- XLR – IP – MAST – MTX

- XLR – IP – AS (With GEO) – MAST (With GEO)
- XLR – IP – AS (With GEO) – MTX (With GEO)
- XLR – AR (Input) – AS – MAST – XLR
- XLR – AR (Input) – AS – MTX – XLR

FOH mix low latency

The following table shows the delay compensation settings for this mix.

<i>Option</i>	<i>On/off status</i>
Master to Matrix Post-processing	Off
Input Channels	
Insert	Off
Aux Sends	
Monitor Mode (Align with Masters)	Off
Insert	Off
Send-FZ-Return	On
Graphic EQ	Off
Master and Matrix	
Insert	Off
Graphic EQ	On

The following signal path examples all measure the same latency of 392 samples at 96kHz = 4.08ms:

- FOH XLR – IP – MAST – XLR
- XLR – IP – MAST – XLR
- XLR – IP – MTX – XLR
- XLR – IP – AS - MAST – XLR
- XLR – IP – AS – INS – AR – MAST – XLR
- XLR – IP – AS – INS – AR – MAST (With GEO) – XLR
- XLR – IP – AS – INS – MAST DI (Mix)
- XLR – IP – AS – INS – MTX DI (Mix)
- XLR – MAST DI (Input)
- XLR – MTX DI (Input)
- XLR – AS DI – MAST – XLR
- XLR – AR (Input) – MAST – XLR
- XLR – IP – MAST – MTX
- XLR – IP – AS – MAST (With GEO)
- XLR – IP – AS – MTX (With GEO)
- XLR – AR (Input) – AS – MAST – XLR
- XLR – AR (Input) – AS – MTX – XLR

Monitor mix

The following table shows the delay compensation settings for this mix.

<i>Option</i>	<i>On/off status</i>
Master to Matrix Post-processing	Off
Input Channels	
Insert	Off
Aux Sends	
Monitor Mode (Align with Masters)	On
Insert	Off
Send-FZ-Return	Off
Graphic EQ	On
Master and Matrix	
Insert	Off
Graphic EQ	On

The following signal path examples all measure the same latency of 243 samples at 96kHz = 2.53ms:

- FOH XLR – IP – MAST – XLR
- XLR – IP – MAST – XLR
- XLR – IP – MTX – XLR
- XLR – IP – MAST – MTX – XLR
- XLR – IP – AS – XLR
- XLR – IP – AS (With GEQ) – XLR
- XLR – MAST – DI (Input) – XLR
- XLR – MTX – DI (Input) – XLR
- XLR – AS DI – AS – XLR
- XLR – AS DI – AS (With GEQ) – XLR
- XLR – AR (Input) – MAST – XLR
- XLR – AR (Input) – MAST (With GEQ) – XLR
- XLR – AR (Input) – MTX (With GEQ) – XLR
- XLR – AR (Input) – MAST – MTX – XLR
- XLR – AR (Input) – MAST – MTX (With GEQ) – XLR
- XLR – AR (Input) – AS – XLR

Monitor mix (low latency)

The following table shows the delay compensation settings for this mix.

<i>Option</i>	<i>On/off status</i>
Master to Matrix Post-processing	Off
Input Channels	
Insert	Off
Aux Sends	
Monitor Mode (Align with Masters)	On
Insert	Off
Send-FZ-Return	Off
Graphic EQ	Off
Master and Matrix	
Insert	Off
Graphic EQ	Off

The following signal path examples all measure the same latency of 176 samples at 96kHz = 1.83ms:

- FOH XLR – IP – MAST – XLR
- XLR – IP – MAST – XLR
- XLR – IP – MTX – XLR
- XLR – IP – MAST – MTX – XLR
- XLR – IP – AS – XLR
- XLR – MAST DI (Input) – XLR
- XLR – MTX DI (Input) – XLR
- XLR – AS DI – AS – XLR
- XLR – AR (Input) – MAST – XLR
- XLR – AR (Input) – MAST – MTX – XLR
- XLR – AR (Input) – AS – XLR

Description

Chapter 29: Panel Connections

This chapter explains the front and rear panel connections of the PRO Series Control Centre.

Front panel connections

The PRO Series Control Centre has two connector panels at the front (left and right) and one to the left of the GUI.

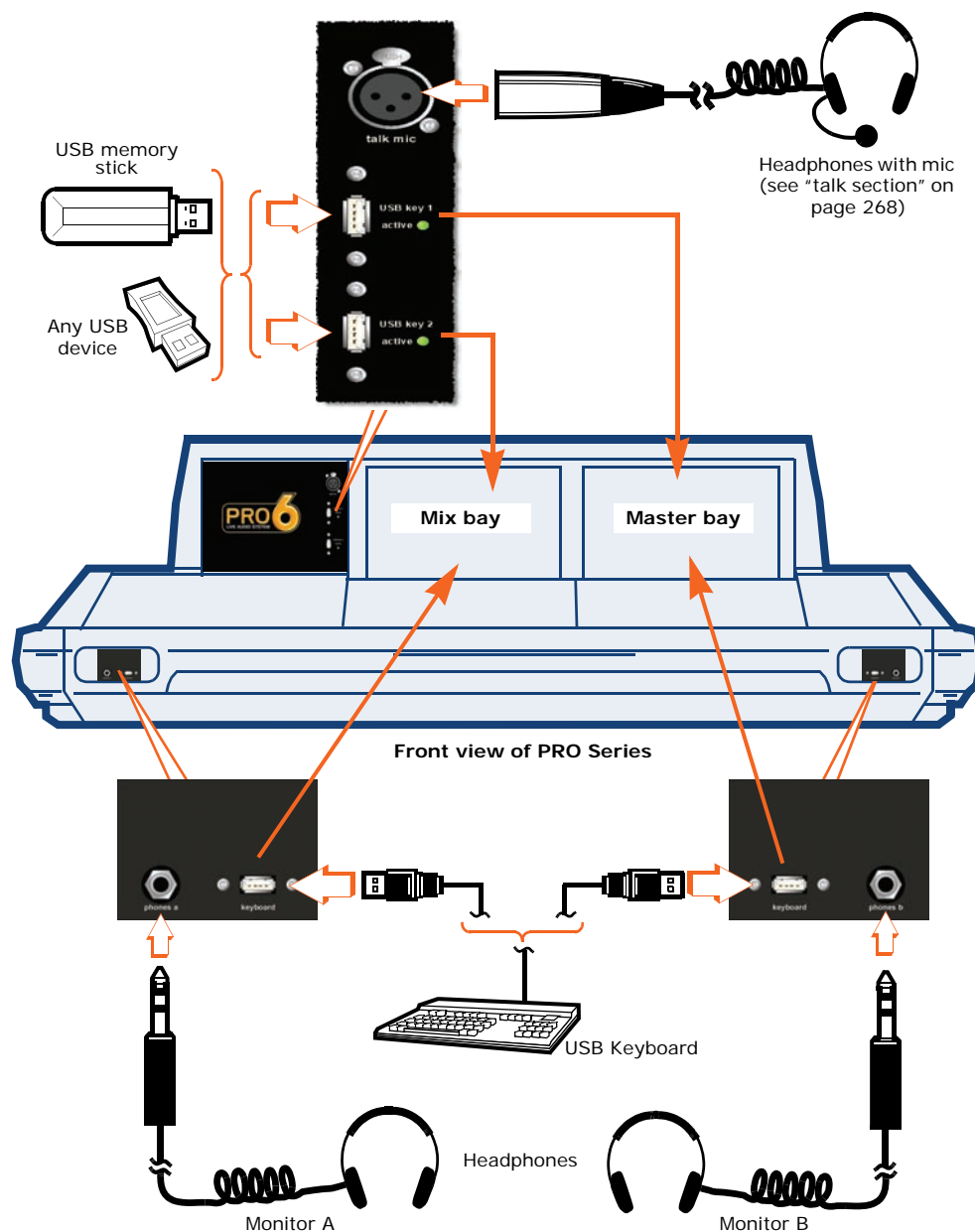

Typical PRO Series Control Centre front panel connections

Rear panel connections

This section details the three main sections of the rear of the PRO Series Control Centre.

Mains power and ventilation section



Caution!

A minimum of two power supply modules must be supplying power to the PRO Series Control Centre for correct operation.

The power supply comprises three identical mains and fan assembly modules. Each mains socket accepts a locking IEC mains connector.

There is a DC power on/off isolator switch above the three modules.

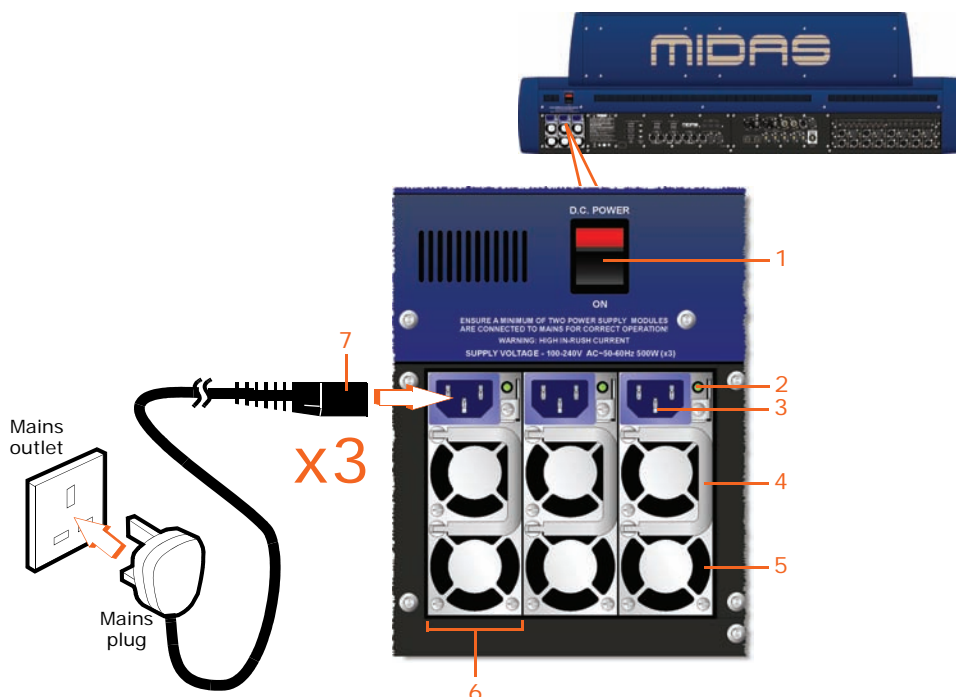

Connecting a PRO Series Control Centre to the mains supply

Item	Description
1	D.C. POWER on/off isolator switch.
2	Green power on/off LED indicator. Illuminates when the power at its associated mains outlet is switched on.
3	Mains IEC socket.
4	Module handle.
5	Fan vent.
6	Mains and fan assembly module.
7	Mains IEC cable assembly, with locking type connector.

External connections and communications (centre left) section

The far left rear connector panel houses the sections shown in the following diagram.



External connections and communications on the rear panel of a PRO Series Control Centre

<i>Item</i>	<i>Description</i>
1	MIDI section (see “MIDI section” on page 268).
2	talk section (see “talk section” on page 268).
3	Monitor/surround outputs section (see “Monitor and assignable outputs/ surround section” on page 268).
4	KVM connections section (see “KVM connections section” on page 267).
5	VGA outputs section (see “External monitor section” on page 272).

KVM connections section

Three sets of **KVM connections** allow three PCs (laptops, tablets etc.) to be connected to the PRO Series Control Centre for external monitoring and control. Each set comprises a **VGA monitor input** 15-way, D-type socket and a **mouse & keyboard output** USB type B socket, which can be used for connection of a mouse or keyboard.

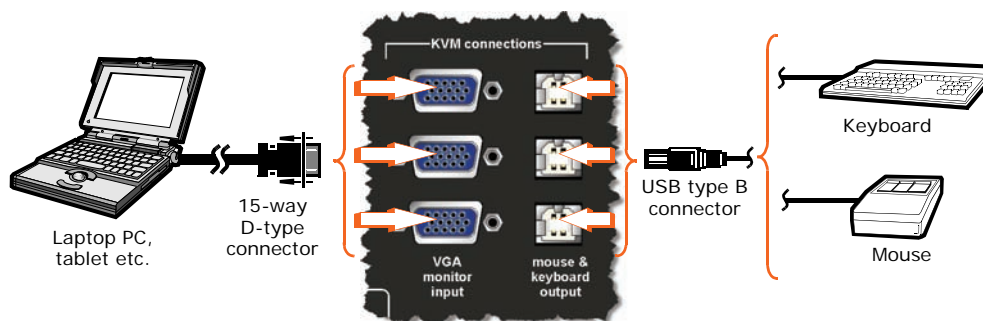

KVM connections on the rear panel of a PRO Series Control Centre

talk section

The talk section has the following connectors:

- **talk output** — male output XLR.
- **talk mic** — female input XLR. This is the equivalent to the talk mic socket on the front panel (see “Front panel connections” on page 265). Use one or the other of these connections, but don’t use both.
- **talk back** — female input XLR.

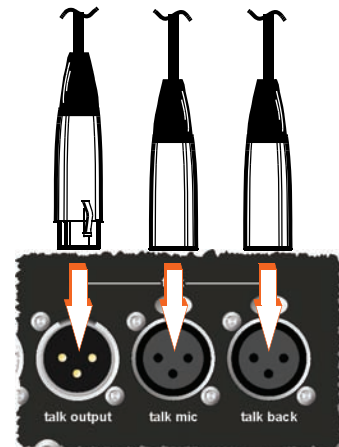
**MIDI section**

The MIDI section has **in**, **out** and **thru** sockets that each accepts a 5-pin DIN connector.

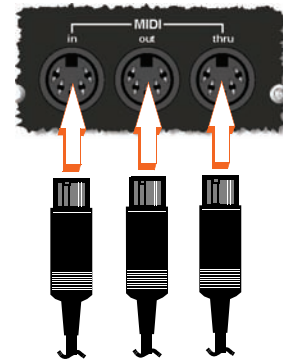
**Monitor and assignable outputs/surround section**

There are two monitor outputs sections (a and b) for the monitor A and B sections, and an assignable outputs section. Each section has right and left connectors.

When the PRO Series is configured for surround panning operation the three output sections function as speaker/subwoofer connectors. The connections for the three types of surround operation (quad, LCRS and 5.1) are shown in Figure 31, Figure 32 and Figure 33. For more information on surround panning, see “Surround panning” on page 120.

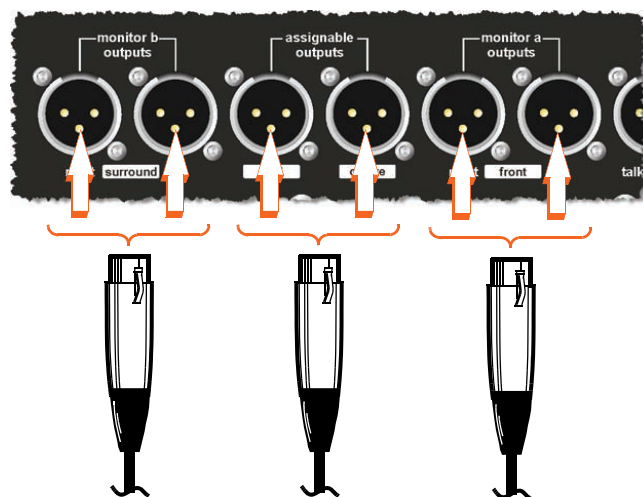

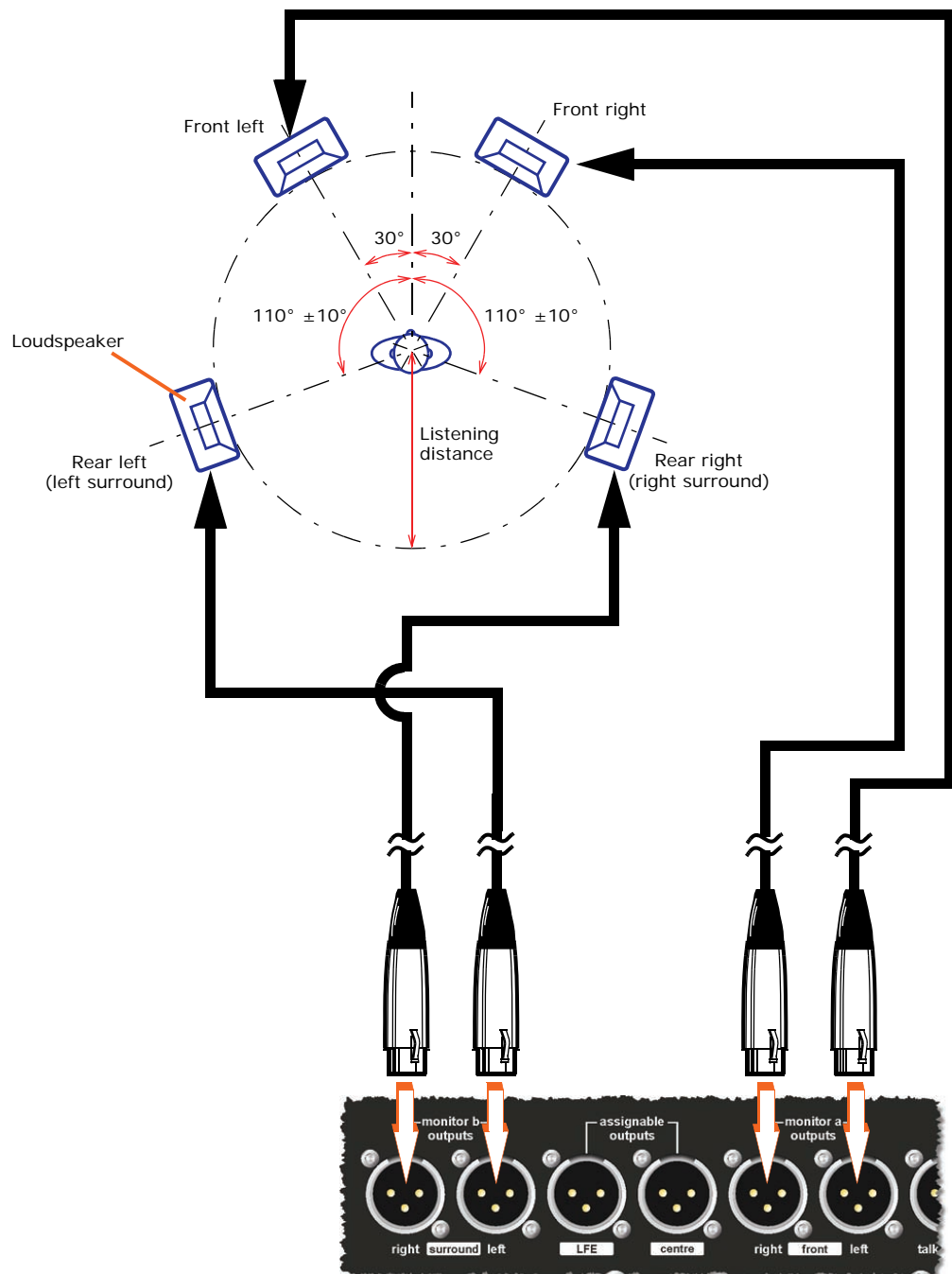

Figure 31: Connections for a quad surround system (with recommended speaker set-up)

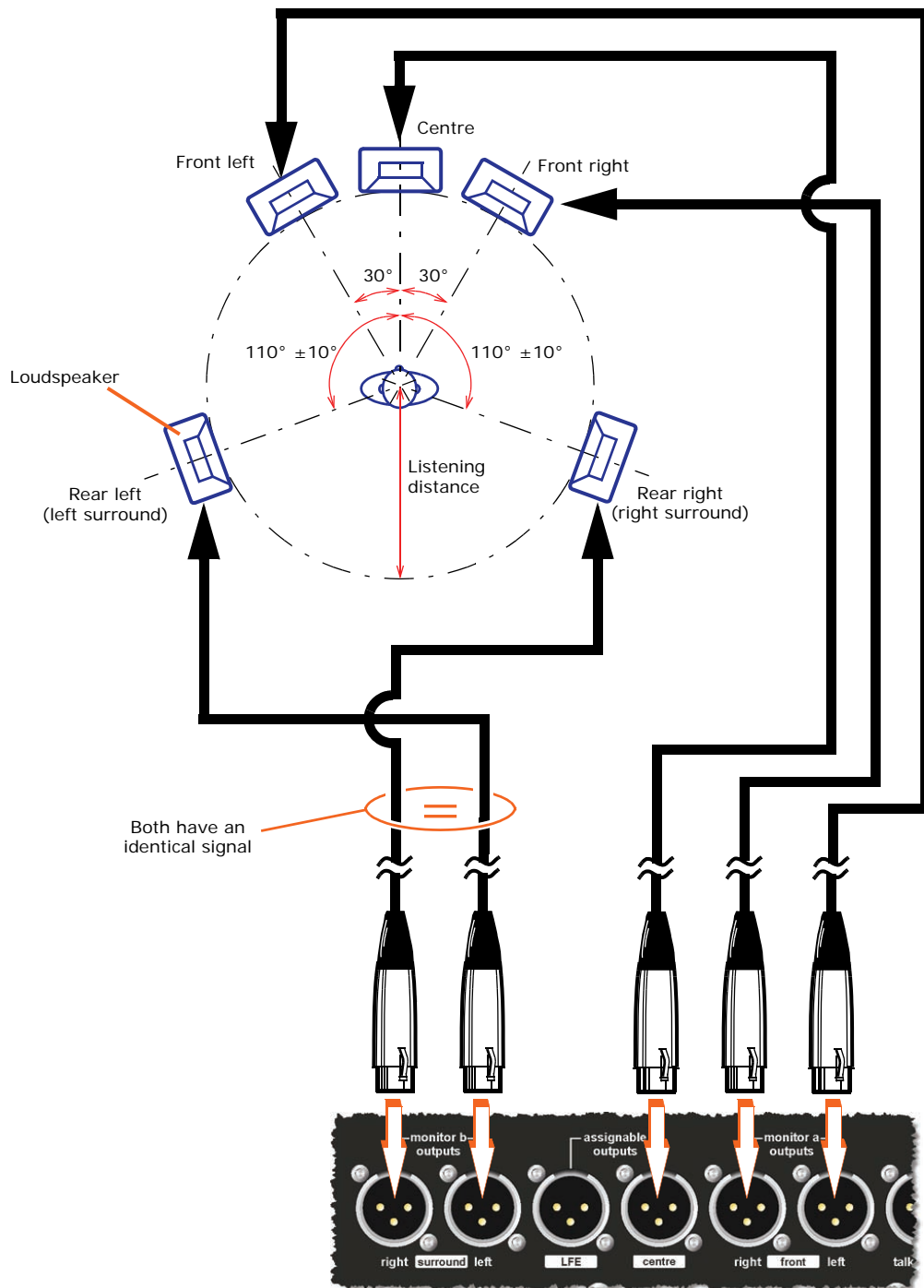

Figure 32: Connections for an LCRS surround system (with recommended speaker set-up)

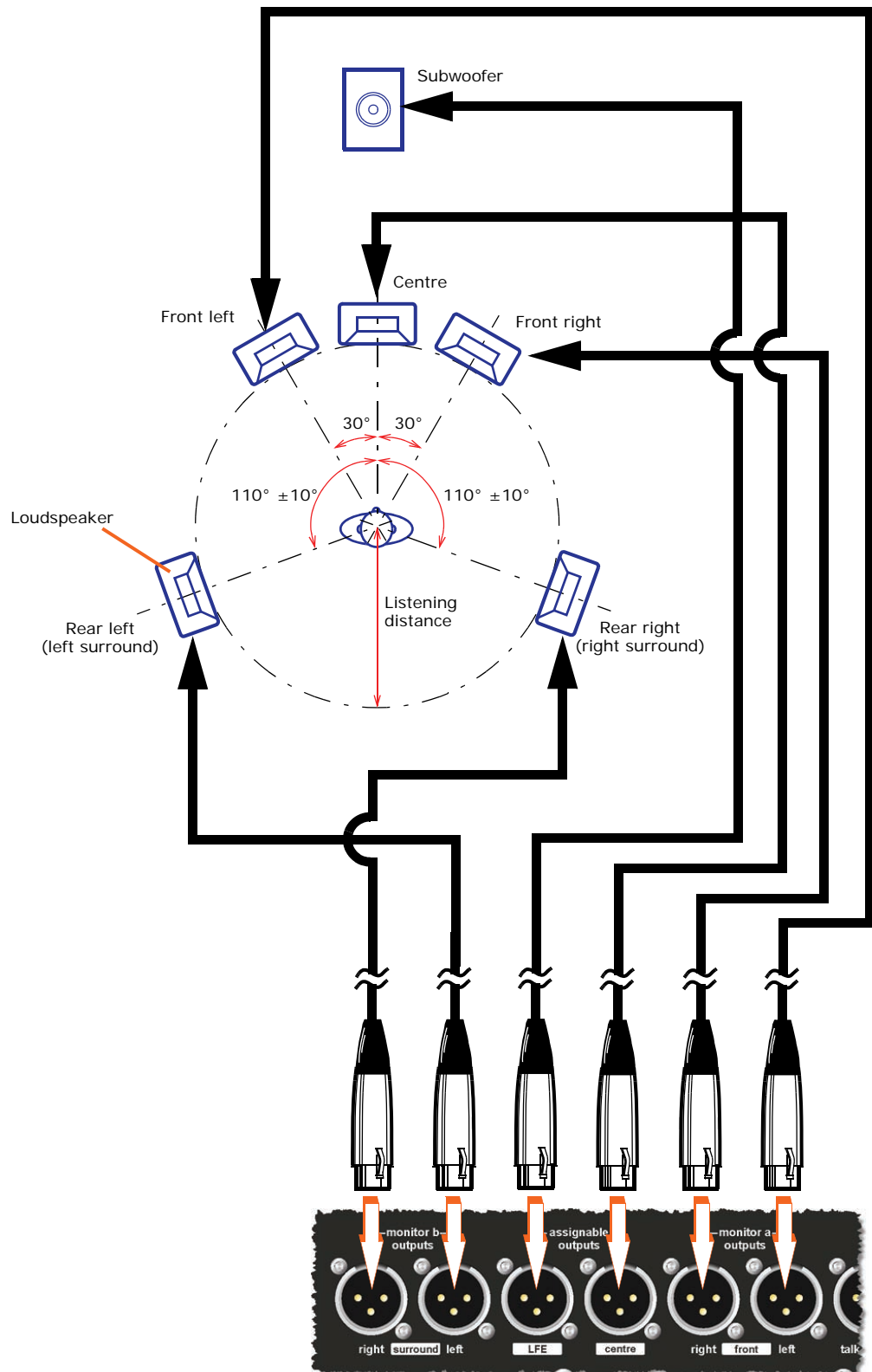
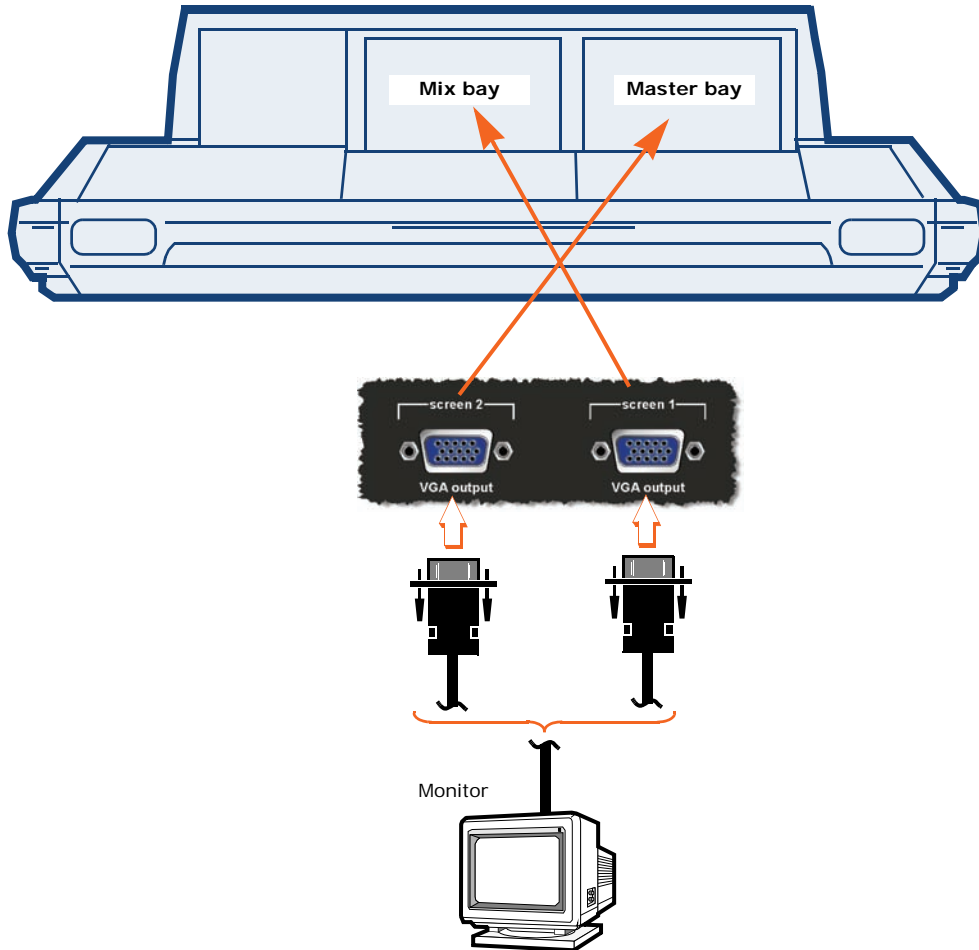

Figure 33: Connections for a 5.1 surround system (with recommended speaker set-up)

External monitor section

You can view exactly what is shown on the GUI's mix and master bay screens on external monitors. Each screen has a 15-way D-type connector into which you can plug an external monitor.



GUI screen associations of the external monitor VGA connectors on the rear panel of a PRO Series Control Centre

Audio, networking and synchronisation section

The centre connector panel houses the following.



Typical audio, networking and synchronisation connections on the rear panel of a PRO Series Control Centre

Item	Description
1	word clock 75R section (see “Word clock” on page 273).
2	AES3 sync section (see “AES3 sync” on page 274).
3	Ethernet tunnel section (see “Ethernet tunnel section” on page 274).
4	Ethernet control section (see “Ethernet control section” on page 274).
5	AES50 audio section (see “AES50 audio” on page 274).
6	snake X and snake Y sections (see “snake X and snake Y sections” on page 275).

Word clock

The **word clock 75R** section comprises **input** and **output** BNC cable sockets for synchronisation with external devices that can transmit/receive a 96kHz word clock signal.

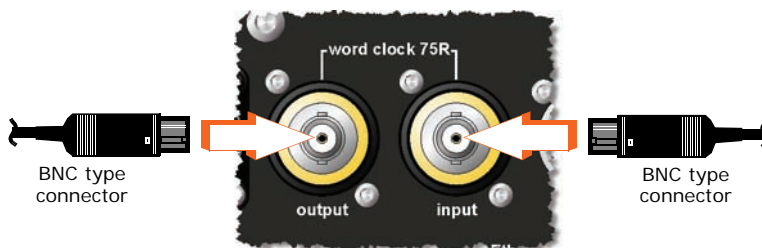

AES3 sync

input and **output** connectors for synchronisation with external devices that can transmit/receive a 96kHz AES3 signal.

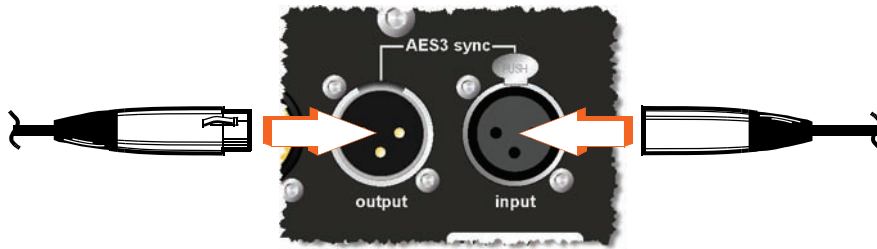

Ethernet tunnel section

An **external** 10Mb/s port (on EtherCon®) allows connection to external non-Midas equipment, such as hubs and switches.

Note: We recommend that you connect this port after the PRO Series Control Centre has powered up, see "Powering the system" on page 42.

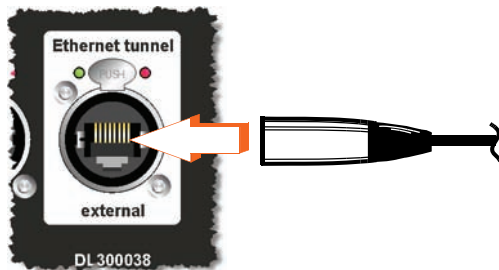

Ethernet control section

Two 100Mb/s **Ethernet control** ports (on EtherCon®) let you connect equipment, such as the Klark Teknik DN9331 RapidE.

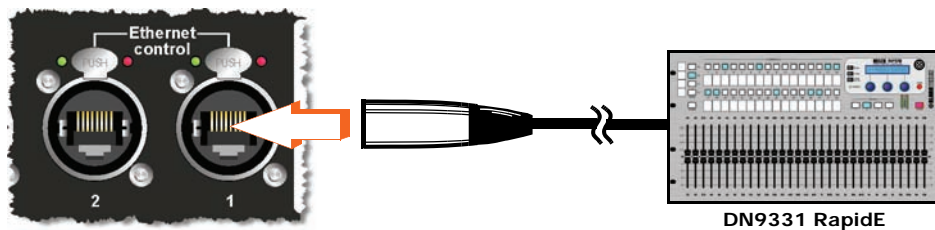

AES50 audio

Three AES50, 24-wide, bi-directional digital audio EtherCon® ports.



snake X and snake Y sections

This section houses the 'snake' ports that connect the PRO Series Control Centre to the stage. (The snakes supplied are dependent on PRO Series type.)

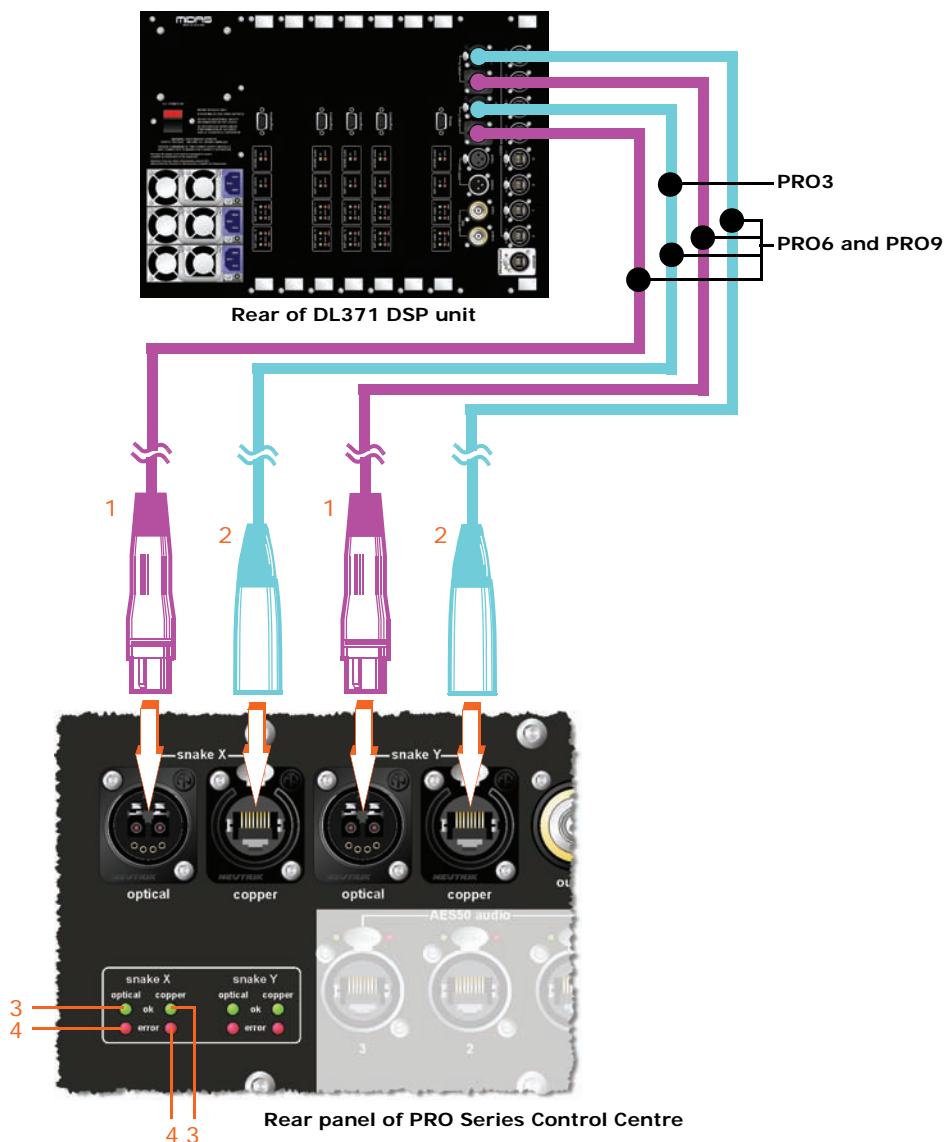

Snake interconnections for the PRO Series Control Centres

Item	Description
1	Fibre optic 'snake' (cable) connectors, with OpticalCon® sockets. These are HyperMac, 192-wide, bi-directional digital audio ports.
2	Copper 'snake' (cable), with EtherCon® connectors. These are Gigabit, HyperMac, 192-wide, bi-directional digital audio ports.
3	ok LED (green) for both the optical/copper X and Y snakes. Pulsates when the link is synchronised between the router and end point.
4	error LED (red) for both the optical/copper X and Y snakes. Illuminates when either no communications or a fault are detected.

I/O section (far right)

The primary system I/O panel has three slots (shown below) for fitting standard 8-way cards as used on the DL451 Modular I/O and DL351 Modular I/O units. This gives a maximum of 24 inputs and 24 outputs, provided the appropriate cards are fitted.



Typical modular I/O section on the rear panel of a PRO Series Control Centre

For information on the I/O modules, see Appendix E "I/O Modules" on page 379.

Chapter 30: Inputs

By default, all of the input channels are mono, although any two adjacent channels can be linked to form a stereo pair. The order of processing in the signal path of both channel types is basically the same.

The order of the descriptive sections in this chapter loosely follow the physical layout of the input fast strips (top to bottom), which is also approximately the signal path taken by the input channels. However, this varies according to signal processing order and the operation of certain controls.

Although the input fast strips in the 12- and 4-channel inputs bays are identical in appearance, their function may vary, depending on the operating mode. Therefore, this chapter will concentrate on the fast strips in the 12-channel input bay and its associated channel strip in the mix bay, although any differences between the two input bays will be highlighted and explained.

Input channel routing

The diagram right shows the default signal path, on which the structure of this chapter is based. This chapter will explain each of these groups of controls, showing the pertinent controls on both the control surface and GUI.

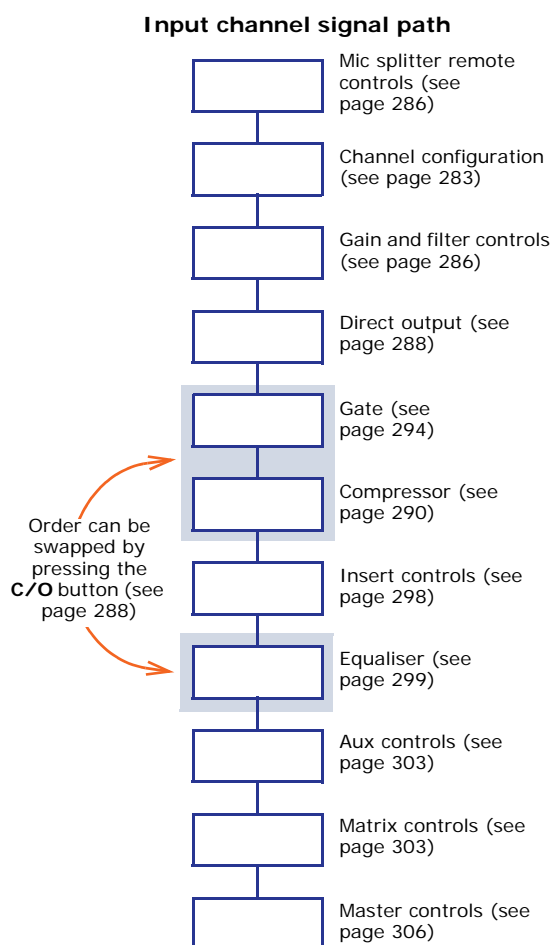

Input channel areas of the control surface

The control surface has a total of 16 input fast strips, so that 16 input channels can be at the control surface at any one time. The input fast strips are divided between the 12-channel input bay (left) and the 4-channel input bay (right).

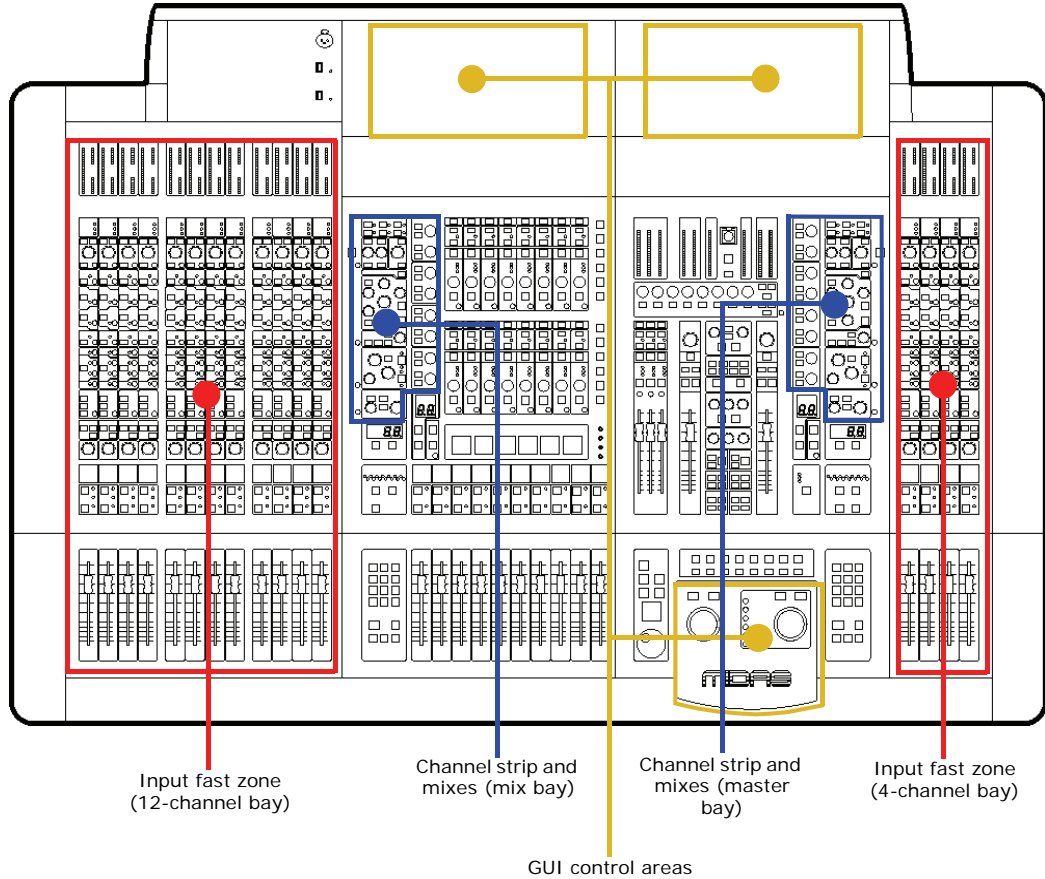

Areas on the control surface concerned with the input channels

Input fast strips, channel strips and mix buses

This section shows the layout of an input fast strip, a channel strip and the mix buses on the control surface. (Only the fast and channel strips of the 12-channel and mix bays are shown here, as the ones in the 4-channel input bay and master bay are similar.)

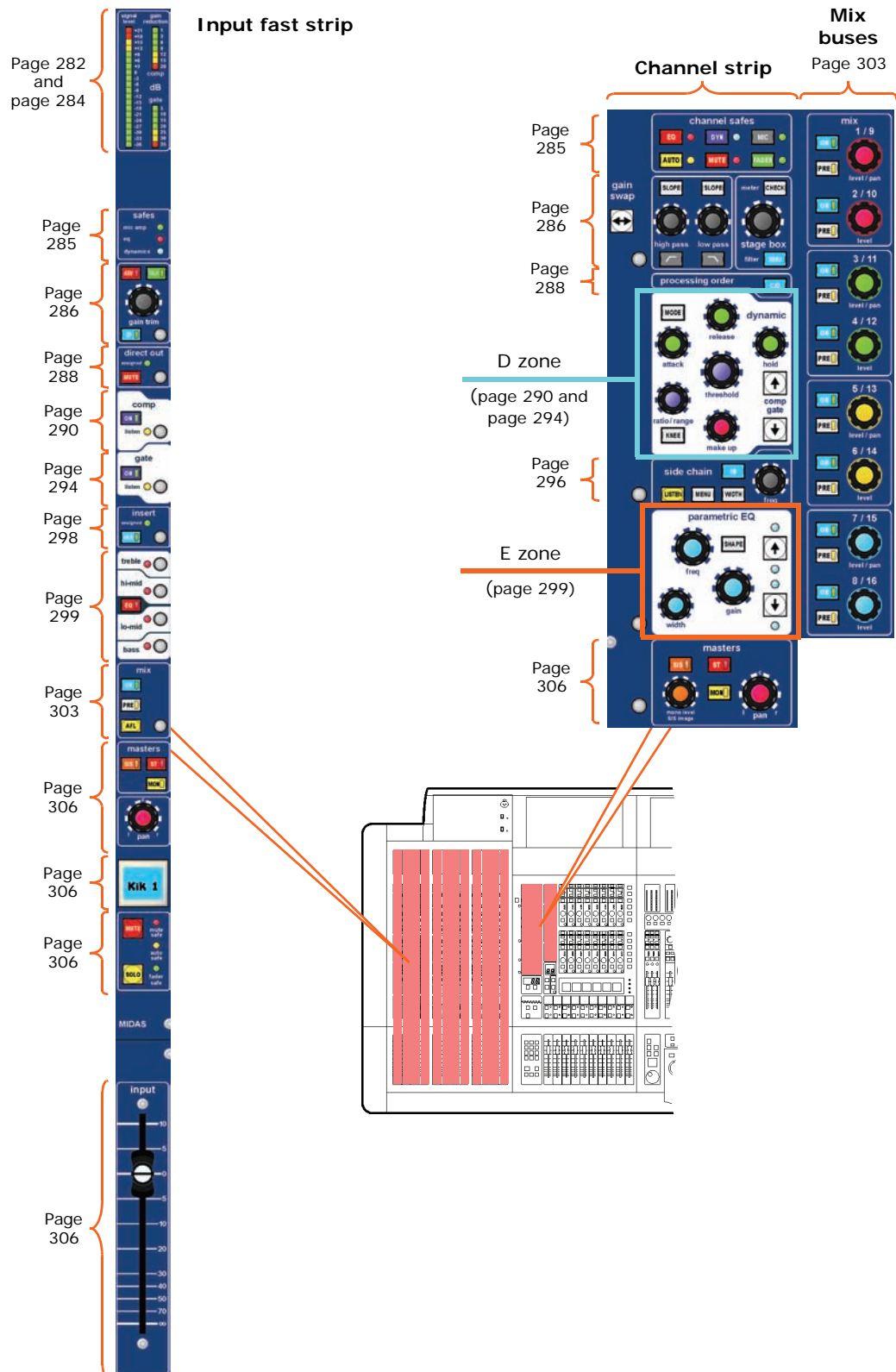

Inputs on the GUI

On the two GUI default screens — **Overview** and **Meters** — the GUI displays 12 and four input fast strips, respectively. These correspond to the input bays on the control surface.

When an input fast strip is selected, the GUI's channel strip displays the channel's **input channel overview**. From this display, you can access processing areas by clicking within specific sections, while avoiding any controls.

For information on how the GUI displays the input channels, see “GUI” on page 30. For details of how to operate the GUI, see Chapter 6 “Working With The Control Centre”.

GUI input fast strips

The input fast strips on the GUI (a typical example is shown right) give an overview of their equivalent versions on the control surface. These show the gain, bus controls, pan control knob and fader.

The **gain trim** section changes its appearance to suit the type of control that has been ‘swapped’ to it (see “Using gain swap” on page 288).



GUI channel strips (inputs)

When an input channel is selected, its overview appears in the channel strip. This is called the “input channel overview” (shown right), and provides limited controls and status information. Clicking a non-control area within a specific section will open that section's processing area, which contains a comprehensive set of controls. The following processing areas are available, which are shown in Figure 34 “Processing areas available from the input channel overview display” on page 281:

- Configuration (direct out, safes and gain trim - channel ID, channel source, filters, linking, swap, delay and processing order)
- Compressor
- Gate
- EQ
- Inserts
- Mix buses
- Masters (faders, solo, panning etc.)

For details of how to navigate the GUI channel strip, see “Navigation via the GUI” on page 68.



Compressor

Configuration

Gate

EQ

Insert

Matrix buses

Aux buses

Masters

input channel overview

Although aux sends 9-16 are not shown, their display is similar to above

This section is not available on the PRO3, as it only has matrices 1 to 8

Although mtx sends 9-16 are not shown (PRO6 and PRO9 only), their display is similar to above

Figure 34: Processing areas available from the **input channel overview** display

Input metering

The **Meters** screen (default view on the master bay GUI screen) shows all of the meters all of the time.

Meters can be switched globally to monitor the raw A/D input point, and are also individually switchable using the **CHECK** button in the **gain trim** section (see “Mic amp input gain (preliminary input processing)” on page 286).

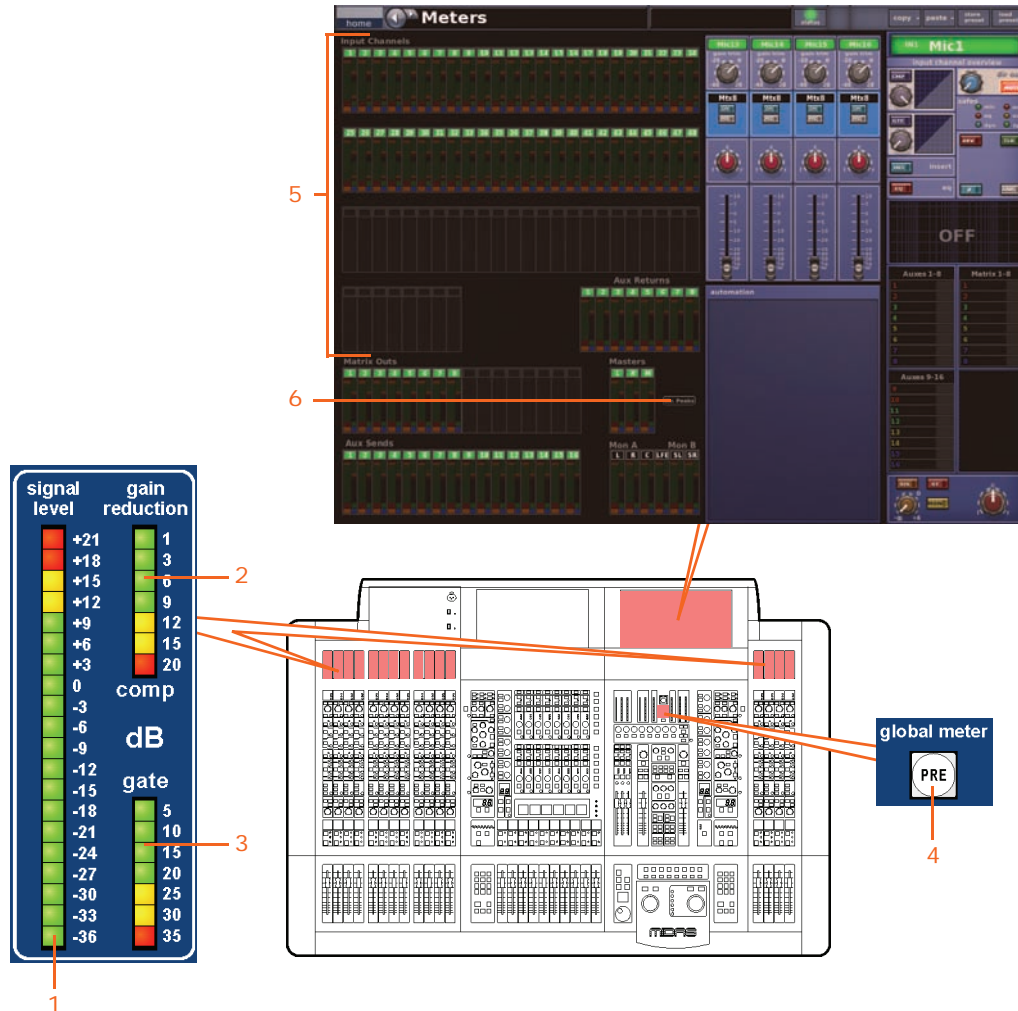

Input metering on the control surface and master bay GUI screen

Item	Element	Description
1	signal level meter	20-segment LED meter 'cluster'. Defaults to monitor pre-fader signal level. Meter range is +21dB to -36dB, in 3dB increments.
2	gain reduction meter	Seven-segment LED meter monitors the amount of gain reduction when using a compressor. Meter range is 1dB to 20dB, in varying increments.
3	gate meter	Seven-segment LED meter, monitors the amount of gain reduction when using a gate. Meter range is 5dB to 35dB, in 5dB increments.
4	PRE switch	Global meter switch that switches all inputs to monitor the raw A/D input point

<i>Item</i>	<i>Element</i>	<i>Description</i>
5	Input channel area	Shows the meters for all of the input channels. Population is PRO Series-type dependent.
6	Clr. Peaks button	This button momentarily clears the meter peaks.

Channel configuration controls

There are a number of input channel controls that are loosely termed 'channel configuration' controls. These comprise:

- **Input channel ID (GUI only):** name and identification. Both the name and colour of the name field are user-configurable. For details, see "Input channel ID (GUI only)" on page 284.
- **Input channel source (GUI only):** shows where the input is routed (patched) from, that is, the physical location the input channel is notionally getting its audio from, and provides direct access to the **Patching** screen. For details, see "Input channel source select (GUI only)" on page 284.
- **Gain swap:** swaps from remote (stage box) gain to digital trim (console gain), and vice versa. For details, see "Mic amp input gain (preliminary input processing)" on page 286.
- **Stereo linking:** links adjacent channel for stereo operation. For details, see "Stereo linking (GUI only)" on page 284.
- **Input channel direct output:** routes signal path from a selected point to an I/O. For details, see "Direct output" on page 288.
- **Input channel safes:** has safe switches that protect specific controls from being changed by the automation system. For details, see "Safes" on page 285.
- **Gain and filter:** mic amp input gain.
- **Inserts:** allows configuration of the send and return points when an insert is used.
- **Input channel delay (GUI only):** user-defined delay to be added to the input signal processing. For details, see "Input channel delay (GUI only)" on page 284.
- **Processing order:** selects whether the EQ or the dynamics comes first in an input channel's signal path.

Their control is divided between control centre and GUI, although some are GUI only. All of them are in the configuration processing area, with the exception of the inserts, which have their own processing area (see Figure 34 "Processing areas available from the input channel overview display" on page 281).

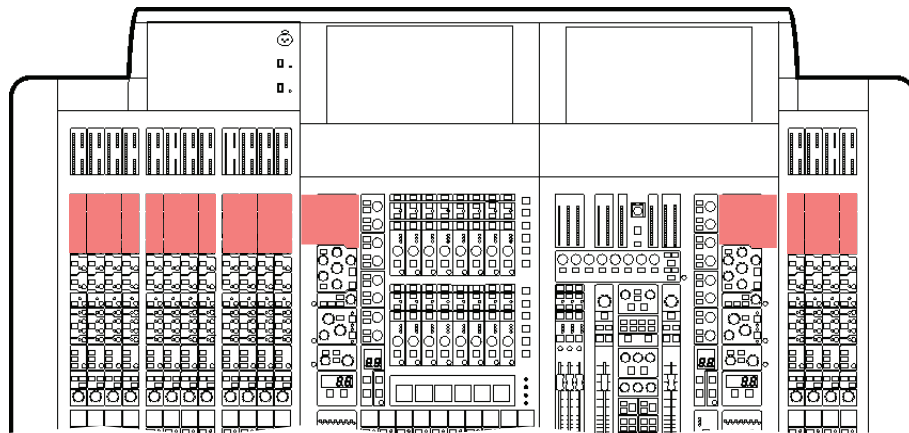

Areas on the control surface concerned with input channel configuration

Input channel ID (GUI only)

You can change the channel name in the GUI strip. This can be done in the input channel overview or in any of the processing areas.



To change the background colour of the input channel name field (green in the example shown), open the **Input Channels Sheet** screen of the GUI menu.

On the control surface, channel ID is displayed on the LCD select button (see "LCD select button" on page 308).

>> To change the channel name in the GUI channel strip

Click within the channel name field and type in the new channel name (see "Text editing" on page 57).

Input channel source select (GUI only)

The channel's source is shown in the text field; if none has been selected, it will contain the text "Unassigned" (as shown right). You can select the source for this channel by clicking **source**, which opens the **Patching** screen (see Chapter 8 "Patching" on page 71).

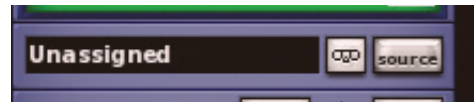

Also, by clicking the recorder button  you can set the input source to tape returns, (for example, for a virtual soundcheck).

Input channel delay (GUI only)

The input channel delay can only be changed via the **delay** section of the configuration processing area (GUI channel strip). This section has a control knob for adjusting the delay in the range 0ms to 50ms; this value is displayed in both milliseconds (ms) and metres (m). You can fine tune the delay value using the spin buttons to the left of the control knob.



The **delay** section lets you incorporate a time delay on an input channel, which is used mainly for mic placements and time aligning to reduce comb filtering. For example, on a drum kit mic set up, you may have a mic close to a snare drum and a couple of overhead mics. In this case, setting an input channel delay on the snare drum — to bring it more in line with the overheads — will probably produce a better sound.

Stereo linking (GUI only)

The linking/gain swap section of the configuration processing has a **LINK** switch for linking the selected input channel to the adjacent input channel on the right. The **LINK OPT.** button opens a **Stereo Linking Options** window from where you can choose which parameters you want to link.

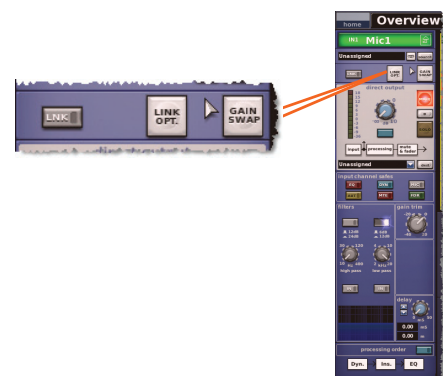

For more information, see Chapter 10 "Stereo Linking" on page 127.

Safes

Each input channel has six different safes that protect specific controls/areas from the automation system.

You can switch the safes on/off by using the buttons in the **channel safes** section of the channel strips or via those in the **input channel safes** section on the GUI, which also illuminate when they are on. The input fast strips on the control surface only provide on/off status information via the LEDs in the **safes** section and the ones just above the faders.

For more information on what areas are protected by each safe, see Appendix M "Parameters Protected By Safes" on page 469.

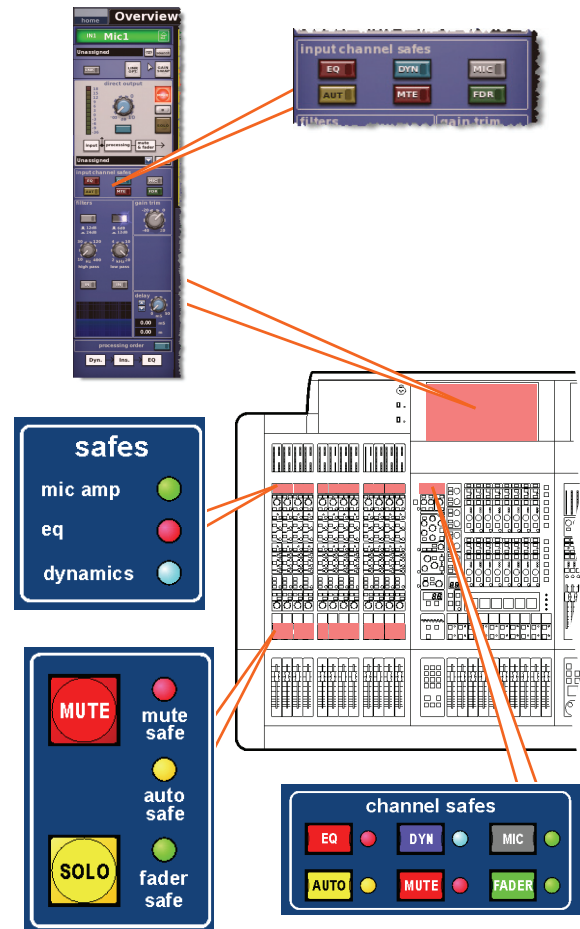

Mic amp input gain (preliminary input processing)



There are two types of mic input channel controls: digital and remote. Most of the controls are digital, which directly affect the parameters stored within the DSP. However, a few controls can also be thought of as remote controls, which control the physical components of the mic splitters and even components that are in the signal path before it enters the digital domain.

The remote controls are dependent on the types of cards fitted in the I/O box. For example, the analogue input module (DL441) has a 48V phantom voltage button and a gain control. The controls are adjusted via the device's configuration window (see "Configuring the devices" on page 89).

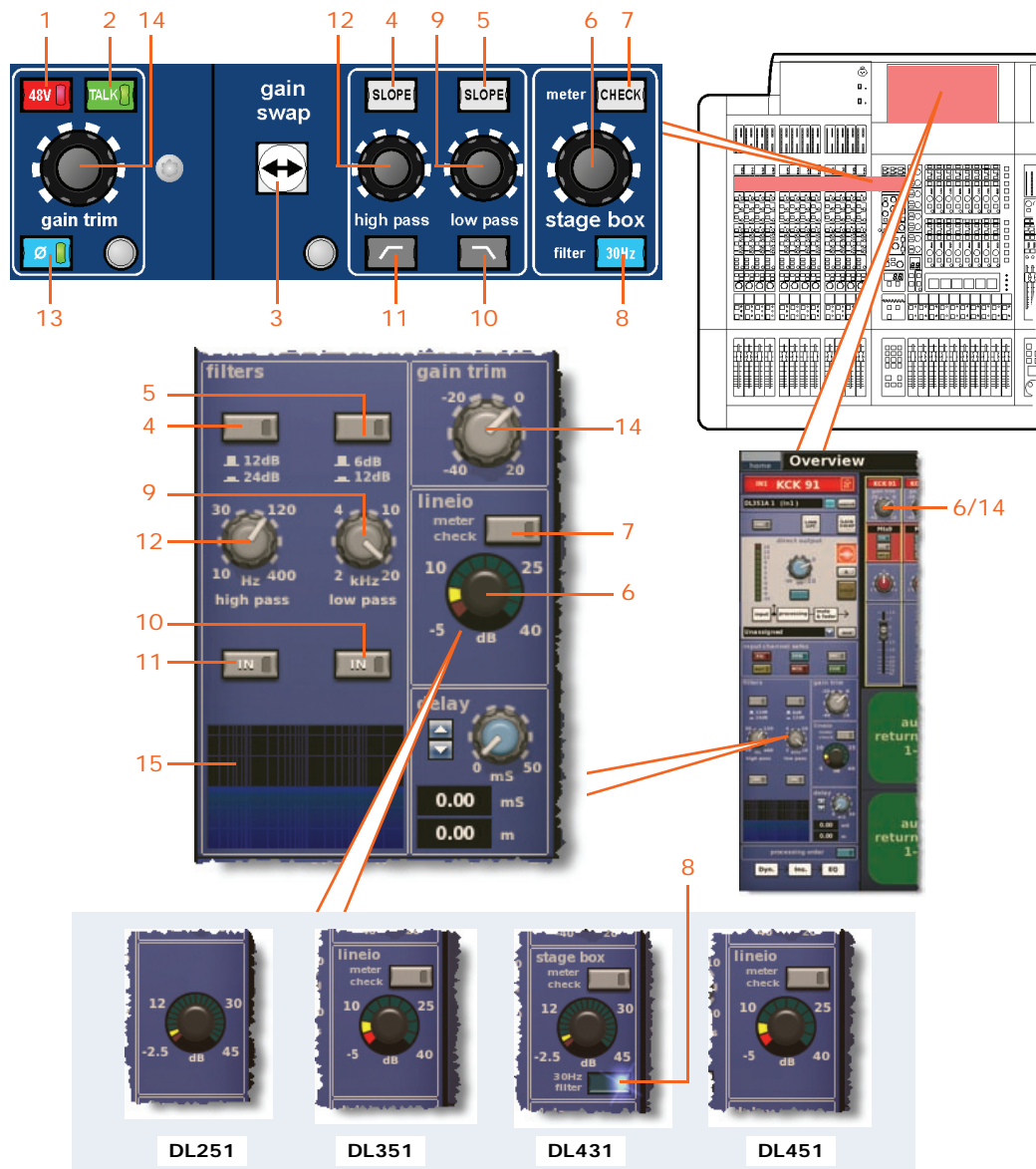
By default, console digital trim is adjusted by the gain trim control knob in each input fast strip and the remote gain control is adjusted by the stage box control knob in the input channel strip. However, by pressing the gain swap button these functions are swapped over, so that the gain trim control knob now controls the remote gain, and the stage box control knob controls the digital trim. Pressing gain swap again reverts them to default. As the legends of these two control knobs on the control surface are permanently fixed, their current 'swap' status can only be determined via the GUI.



Mic amp input gain on the control surface and GUI

<i>Item</i>	<i>Control</i>	<i>Function</i>
1	48V switch (stage box only)	Connects 48 volts of phantom power to the XLR mic input channel connector. Suitable for a condenser microphone or DI box.
2	TALK switch	Connects talk mic and/or tone and noise generators to the input channel.
3	Gain swap button	See "Using gain swap" on page 288.
4	SLOPE switch (digital trim only)	Selects the value of the high pass filter. Where, switch on (illuminated) = 24dB slope and switch off (extinguished) = 12dB slope.
5	SLOPE switch (digital trim only)	Selects the low pass filter. Where, switch on (illuminated) = 12dB slope and switch off = 6dB slope.
6	stage box control knob	Adjusts the input gain of the remote amplifier in 5dB steps, ranging from -5dB to +40dB. Note that the stage box control knob on the control surface will only adjust the gain currently selected to the GUI input channel strip, that is, stage box or digital trim.
7	CHECK switch (stage box only)	Monitors the mic amp input after the 30Hz filter, but before any further processing. (The 30Hz subsonic filter switch accesses the high pass filter on DL431 Mic Splitter if the PRO Series is connected to an XL8. In this case, gain steps would be 2.5dB to +45dB.)
8	30Hz subsonic filter switch	Acts on remote amplifier (mic splitter) to remove very low frequencies in the audio signal — usually caused by noise on stage. This avoids wasting valuable headroom trying to digitise it. This button changes the meter to monitor mic amp output directly.
9	low pass control knob (digital trim only)	Adjusts frequency of low pass filter in the range 2kHz to 20kHz.
10	Low pass filter switch  /[IN] (digital trim only)	Activates low pass filter in the input channel signal path before the insert points and EQ.
11	High pass filter switch  /[IN] (digital trim only)	Activates high pass filter in the input channel signal path before the insert points and EQ.
12	high pass control knob (digital trim only)	Adjusts frequency of high pass filter in the range 10Hz to 400Hz.
13	Phase switch \emptyset	Applies a 180° inversion of the input signal polarity within the input amplifier, such that channel signal will have opposite polarity to the input signal. This is used to correct input signal phase problems when trying to sum signals that are 180° out of phase. For example, where two mics are facing each other when using a mic on both the top and bottom of a snare drum. Ordinarily, the two mics would be out of phase - causing cancellation when the control centre sums the two signals into the output. Reversing the phase of one signal causes the mics to have the same phase, thus avoiding cancellation.

Item	Control	Function
14	Gain trim (digital trim) control knob	Applies continuous trim adjustment (small digital steps) of the input signal level in the range -40dB to $+20\text{dB}$. Gives a further 40dB of fine adjustment (DSP) on top of the remote amplifier gain setting. Note that this control knob (control surface only) will only adjust the gain currently selected to its GUI input fast strip, that is, stage box or digital trim.
15	Graph	Shows the effects of currently applied filter.

Using gain swap

Operating the gain swap button, swaps the function of the **gain trim** (digital trim) section (top of input fast strips) to that of the **stage box** section (GUI channel strip). The effects of this action are only shown on the GUI, as illustrated in the diagram right.

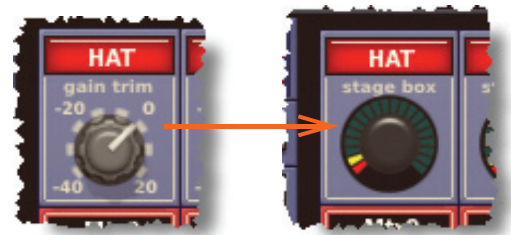

Always check the GUI for 'swap' status.

Processing order

The **processing order** section (control surface and GUI) has a button that changes whether the EQ or the dynamics comes first in an input channel's signal path. The current order of processing is only shown on the GUI, just under the **processing order** section.

Gate always precedes compression, no matter what the processing order is set to.

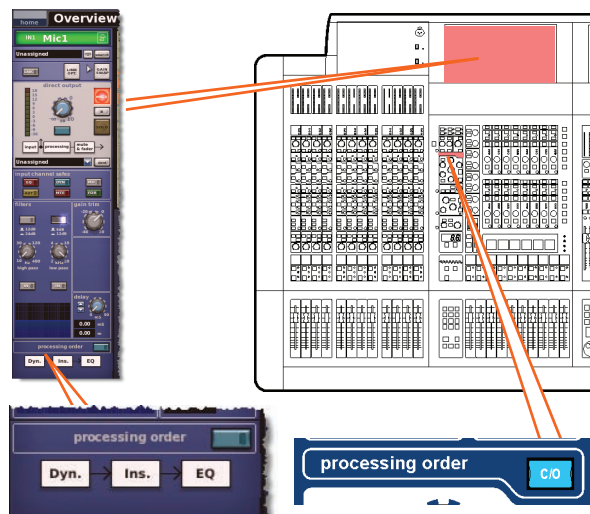

Direct output

The direct output section provides an internal connection to effects etc. or a way of leaving the control centre via an I/O box. It lets you take a signal directly out of a defined point in the input channel's signal path and route it to either an internal assignable effect or a physical output (a physical connection at one of the line I/O boxes). This function is optional and assigned on a channel-by-channel basis.

This section is deliberately distanced from the main channel panel controls because it is a limited resource and unused on many channels.

Selection of signal path position (item 4) and destination (item 5) can only be carried out via the GUI.

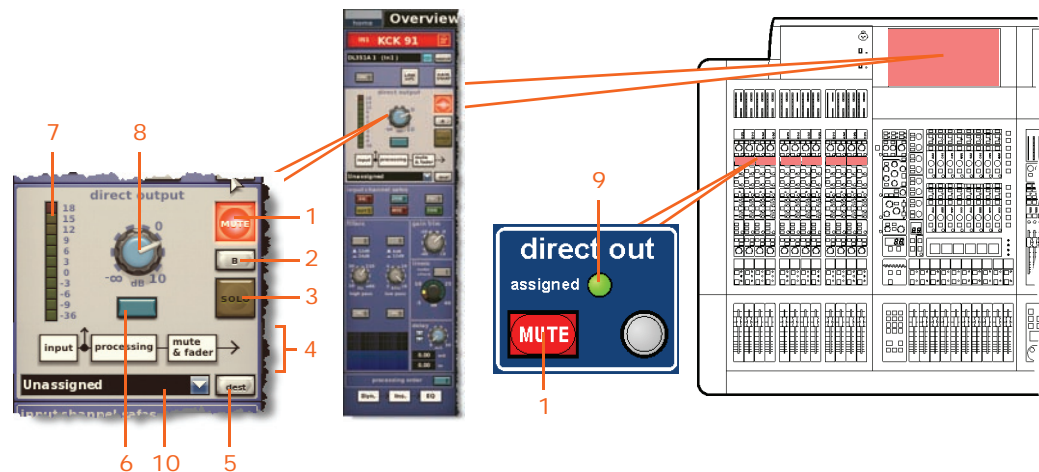

Direct output controls for the input channels on the control surface and GUI

Item	Control	Function
1	MUTE switch	Mutes any assigned direct output by removing signal from the output. However, it will not operate (will remain illuminated) if nothing is assigned. It is included in the scene recall system but is not affected by the channel mute safe or the auto-mute masters (unless the source tap-off point is after the main channel mute).
2	Solo B switch	Changes the operation of the SOLO switch so that it routes signals to the monitor B section of the control centre.
3	SOLO switch	Activates signal routing to the Monitor A section of the control centre.
4	Tap-off point graphic	Shows where the direct output is sourced from in the signal path, as selected by the mode button (see item 6).
5	dest button	Opens the Patching screen so that you can select the destination of the direct output.
6	Mode button	Changes the source tap-off point for the signal. There are three options: post-fader and mute; pre-mute and post-processing; or pre-mute and pre-processing. This function is not used if the direct output is not assigned to channel.
7	Meter (10-LED)	Monitors the direct output level in the range +18dB to -36dB.
8	Control knob	Adjusts direct output level. Range is infinity (∞) to 10dB.
9	assigned LED	Illuminates when a direct output is in use.
10	Direct output drop-down list	Displays the destination(s) of the direct output. For example, to an O/B vehicle, while simultaneously going into a DN9696.

Dynamics (D zone)

The **dynamic** section — or D zone — controls two dynamic devices present in the input channel signal path, that is, the compressor and gate. While most D zone controls are shared between the two dynamic devices, some are device-specific. The GUI treats both devices independently, the processing area of the one currently displayed in the channel strip being the one currently selected to the D zone. Swapping between the two dynamic devices can be done via an input fast strip, the D zone or the GUI (see Chapter 7 "Navigation" on page 59). Operating the dynamic device's **ON** button activates the device, but also affects the audio.

You can select the source of both the compressor and gate, and also use the side chain for both. For side chain details, see "Side chain" on page 296.

Compressor

The input channel compressor has four styles — corrective, adaptive, creative and vintage — which are selectable via the **MODE** button. Each has a distinctive appearance in the GUI channel strip. While the dynamic section is addressing the compressor, all of its controls are enabled except the **hold** control knob.

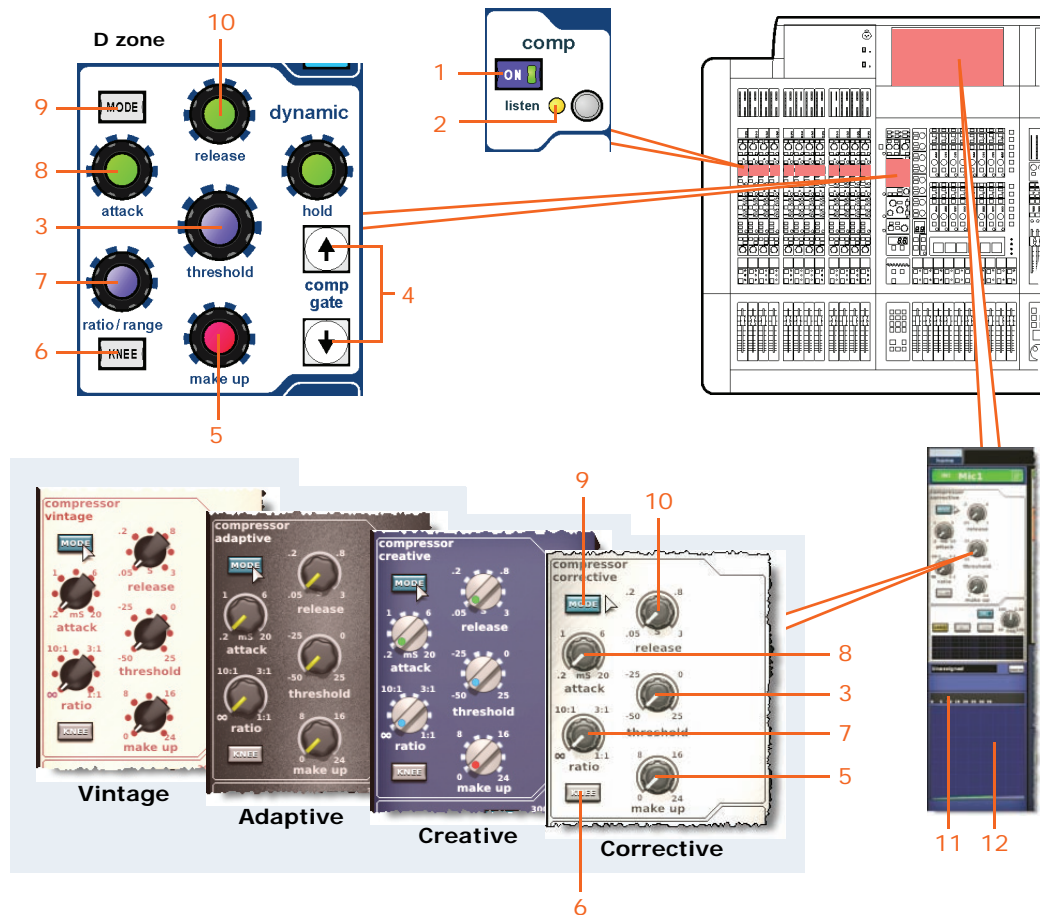

Compressor types and their input channel controls (control surface and GUI)

<i>Item</i>	<i>Control</i>	<i>Function</i>
1	ON switch	Enables the compressor in the signal path. When switched off, compressor is bypassed. (Both the comp and gate switches can be on at the same time.)
2	listen LED	To aid set up, the compressor has a side chain listen that sends the side chain onto a solo bus. The listen LED illuminates to warn you that soloed material is from the side chain, and not the main channel. For information on the side chain, see "Side chain" on page 296.
3	threshold control knob	Sets the signal level above which gain reduction starts to be applied. Range is from -50dB to +25dB.
4	comp/gate up and down select buttons	Swaps dynamic section control from compressor to gate, and the reverse.
5	make up gain control knob	Compensates for the reduced <i>loudness</i> of a compressed signal. Range is from 0dB to 24dB.
6	KNEE switch	Controls how compressor starts to apply gain as the signal goes through the threshold; see "Knee type" on page 293. For a description of the options, see Table below. For more information, see "Knee" on page 342.
7	ratio/range/ [ratio] control knob	Adjusts amount of compression applied to signals above threshold. Range is from infinity (∞) to 1:1. When set to maximum (1:1), sets compressor to limiter mode.
8	attack control knob	Adjusts time for compressor to respond after an over-threshold signal. Range is from 0.2ms to 20ms (milliseconds).
9	MODE switch	Selects compressor mode. There are four compressor types available: corrective , adaptive , creative and vintage . See "PRO Series compressor modes (dynamic)" on page 341 for details.
10	release control knob	Adjusts time for compressor to recover after programme material falls back below threshold. Range is from 0.05s to 3.00s (seconds).
11	Gain reduction meter	Mimics the gain reduction meter at the top of the input channel's fast strip (see "Input metering" on page 282).
12	Graph	See "Compressor graph" on page 292.

Compressor graph

This section uses examples to illustrate the affect on the compressor graph of adjusting the compressor's parameters.

Ratio

The following diagram shows a signal on the compressor graph with ratio applied; it shows the point of threshold and how ratio affects the gradient of the signal following this. The graph on the right shows an uncompressed signal, that is, with no ratio applied.

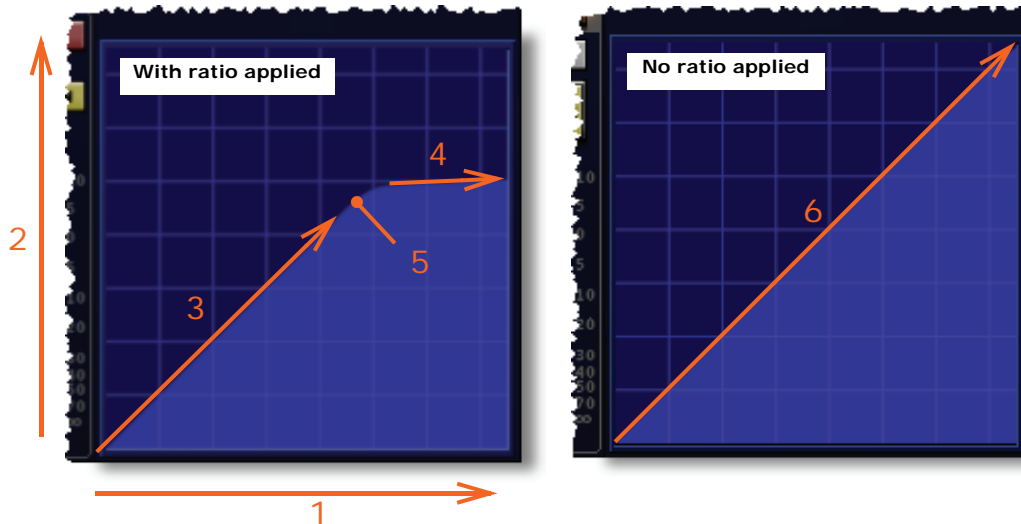

Graphs showing the effect of applying ratio

Item	Description
1	Input level The 'x-axis' of the graph.
2	Output level The 'y-axis' of the graph.
3	This portion of the graph is pre-threshold and is unaffected by compression, that is, with a gradient of 1:1.
4	This portion of the graph is post-threshold and shows the effects of compression. The gradient is the same as the compression ratio.
5	Threshold The point where the gradient changes and where compression starts to be applied.
6	Graph with no ratio applied, that is, 1:1 gradient. (What you put into the compressor, you get out.)

Threshold

The following diagram shows the affect on the compressor graph of adjusting threshold.

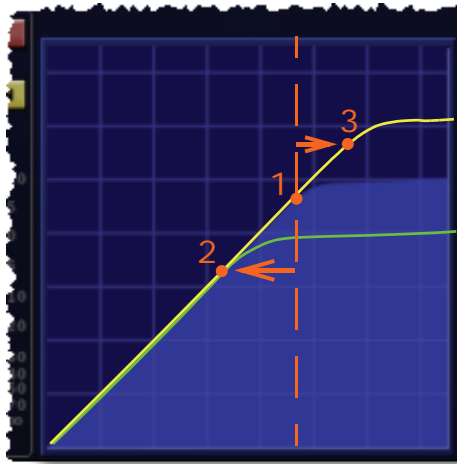

Item	Description
1	Threshold: The point where the gradient changes and where compression starts to be applied.
2	A threshold reduction will move the threshold point left, as shown in the example above (green line). Less signal is passed 1:1.
3	A threshold increase will move the threshold point right, as shown in the example above (yellow line). More signal is passed 1:1.

Knee type

There are three knee types as follows, which are illustrated in the following diagram:

- **Hard knee** Compressor immediately applies gain reduction at selected ratio once attack time has elapsed.
- **Medium knee** Intermediate knee type.
- **Soft knee** Compressor, starting from slightly before threshold, gradually makes the transition to applying gain reduction at selected ratio.

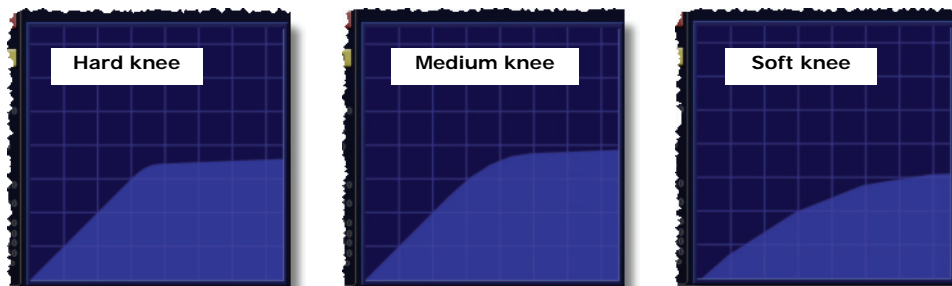

Graphs showing the three knee types. Note that hard knee has hardly any curve at all, while the knee becomes noticeably more rounded in soft knee mode.

Compressive display types

With a signal running through the compressor, a coloured line on the graph follows the contour of the shaded graph area. The line's colour changes according to which of the three signal levels it is at.

- **Uncompressed** If signal doesn't reach threshold (point where gradient changes), the line is green. As the threshold is not exceeded, the signal is uncompressed.
- **Within knee area** If signal goes into knee area to point where gradient changes (more obvious with medium and soft knees), compression starts to be applied and line colour changes to yellow.
- **Full compression** If signal reaches the point where gradient changes (over-threshold), full compression at selected ratio is applied and line colour changes to red.

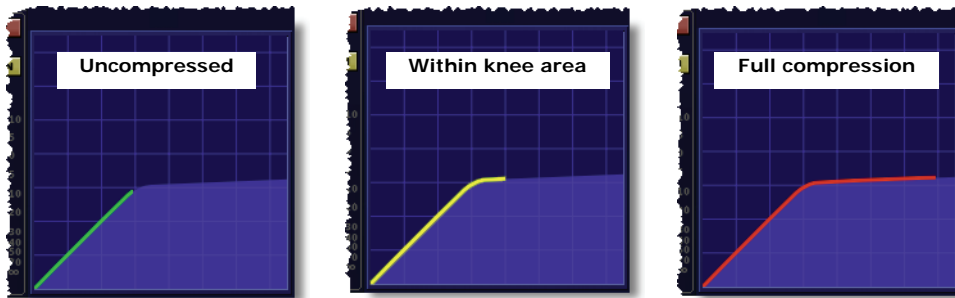

Typical graphs showing the line representing the signal level as it follows the contour of the compressor envelope and changes colour as it passes through the knee

Gate

While the **dynamic** section is addressing the gate, all of its controls are enabled except the **make up** control knob and the **MODE** and **KNEE** buttons.

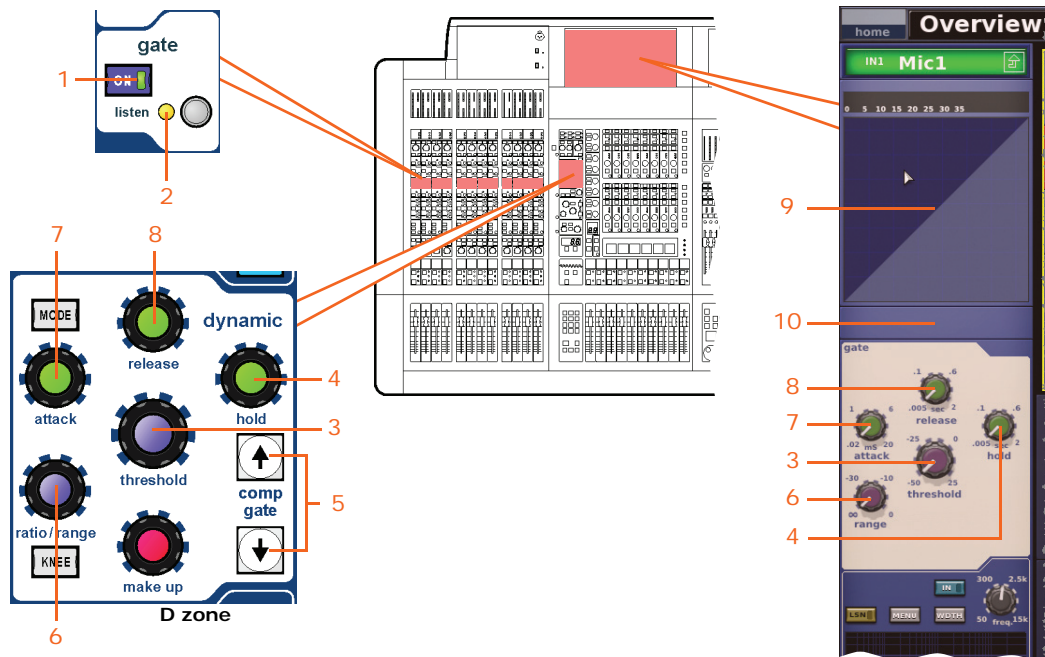

Gate controls for the input channels on the control surface and GUI

<i>Item</i>	<i>Control</i>	<i>Function</i>
1	ON switch	Enables gate in the signal path. When switched off, gate is bypassed. (Both the comp and gate switches can be on at the same time.)
2	listen LED	To aid set up, the gate has a side chain listen that sends the side chain onto a solo bus. The side chain listen LED indicator illuminates to warn you that soloed material is from the side chain, and not the main channel. For information on the side chain, see "Side chain" on page 296.
3	threshold control knob	Sets signal level at which gate opens. Range is from -50dB to +25dB.
4	hold control knob	Minimises chattering in conjunction with internal hysteresis. Once the signal is detected as below threshold, this defines a waiting period before the gate starts to close. Range is from -0.005s to 2.000s (seconds).
5	Up/down select buttons	Swap dynamic section control from compressor to gate, and vice versa.
6	ratio/range/ [range] control knob	On the gate, this control adjusts the amount of gain reduction applied to the signal below threshold. Controls the maximum gain reduction that is possible. Range is from minus infinity ($-\infty$) to zero.
7	attack control knob	Adjusts time taken for gate to open after an over-threshold signal. Range is from 0.02ms to 20ms (milliseconds).
8	release control knob	Adjusts time taken for gate to close after programme material falls back below threshold. Range is from -0.005s to 2.000s (seconds).
9	Graph	Shows the effects of adjusting the gate's parameters.
10	Meter	The gate meter mimics the gate meter at the top of the input channel's fast strip (see "Input metering" on page 282).

Side chain

You can manipulate the side chain filter from the **side chain** section (channel strip and GUI). The side chain filter is a swept band pass type, which acts on the dynamics side chains of the compressor and gate, and covers the full audio spectrum.

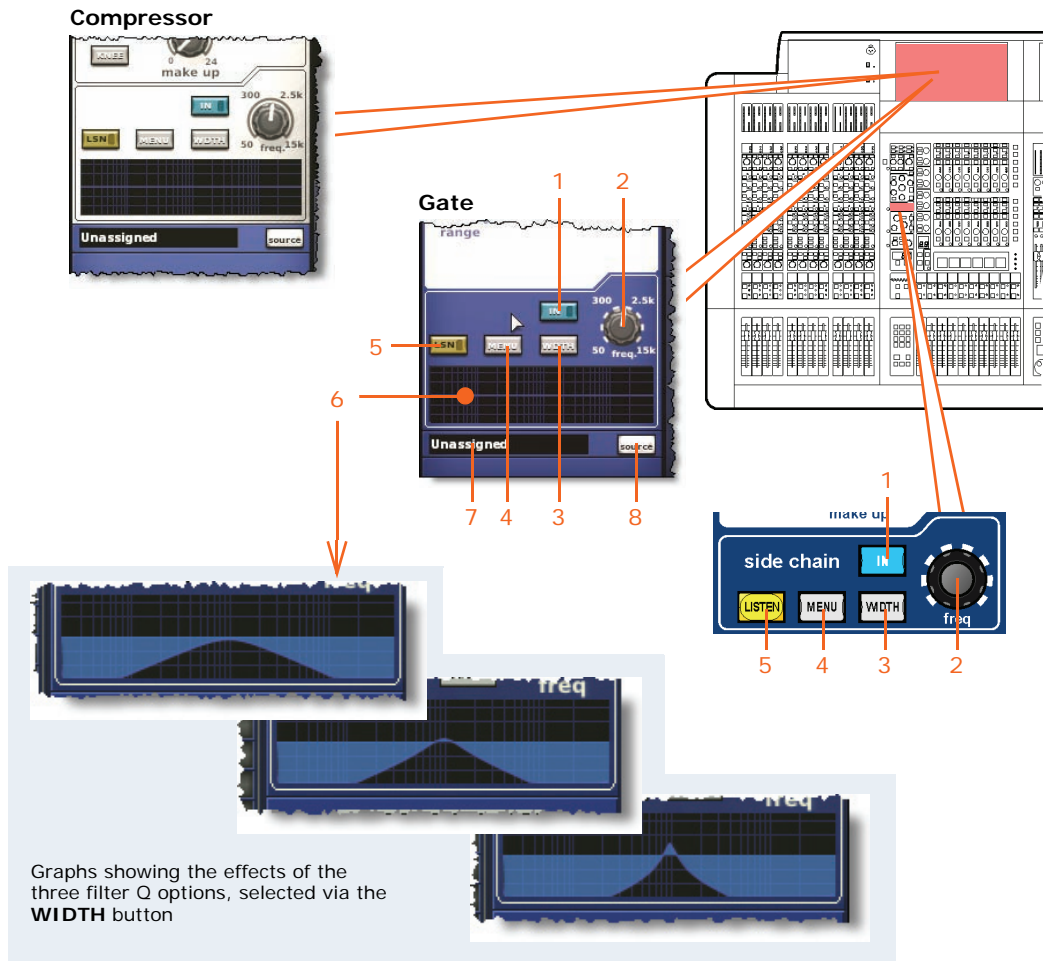

Side chain controls for the input channels on the control surface and GUI

Item	Control	Function
1	IN switch	Switches the side chain filter into the signal path.
2	freq control knob	Adjusts the side chain filter frequency in the range 50Hz to 15kHz. (Visually, this moves the envelope on the graph left or right.)
3	WIDTH button	Changes the filter Q. There are three options, and the effects of each are shown in the side chain graph (see above). This is only enabled when the side chain filter is switched on.
4	MENU button	Opens the Select Side-Chain Source window from which you can select the side chain source for the selected input channel. Pressing this button with the Select Side-Chain Source window open, closes the window.

<i>Item</i>	<i>Control</i>	<i>Function</i>
5	LISTEN/[LSTN] switch	Places the side chain pushbutton onto the channel filter bus, allowing the audio signal to be monitored via headphones. This, effectively, replaces the channel solo audio path with a post-filter (pre-dynamic) signal.
6	Graph	Shows the effects of the side chain filter on the signal.
7	Side chain source field	Shows you where the side chain of the compressor/gate is sourced from. If you see the text "Unassigned" here, it means that a source hasn't been assigned.
8	source button	Opens the Patching screen, so that you can select the sidechain source.

Insert

Input channel insert section provides a send and return out of the signal path, primarily so that an effects device can be added to the signal's processing. The send destination and return source may only be set from the GUI screen, although the **INS** switch can be found on both the GUI and also in each input fast strip. This section is optional and assigned on a channel-by-channel basis.

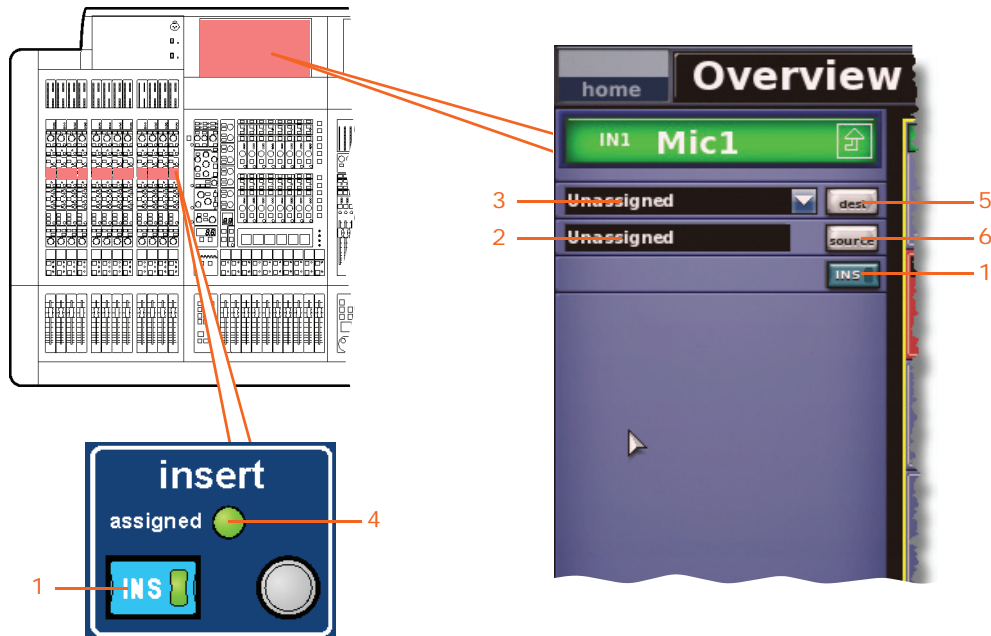

Insert controls for the input channels on the control surface and GUI

Item	Control	Function
1	INS switch	Connects (inserts) returned programme material to the channel signal path, provided both the insert send and insert return points have been assigned.
2	insert return field	Shows you the source of the insert return.
3	insert send field	Has a drop-down list, which shows the destination(s) of the insert send.
4	assign LED	Green LED that illuminates to show that an insert return point is patched.
5	dest button	Opens the Patching screen from where you can select the destination of the insert send.
6	source button	Opens the Patching screen from where you can select the source of the insert return.

EQ (E zone)

The input channel equaliser (EQ) is a four-band sweep parametric EQ (PEQ) that allows tonal control of the input signal via the parametric EQ section, or E zone, in the input channel strip. The four bands are treble, hi-mid, lo-mid and bass, with an additional three shelving modes available for treble and bass. Any combination of the four bands can be used to control the signal, although only one band can be adjusted in the E zone at any time.

Each input fast strip contains the EQ on/off switch and quick access buttons for channel and band selection.

The E zone contains all of the PEQ controls, along with a shelving mode selection button and another set of band selection buttons.

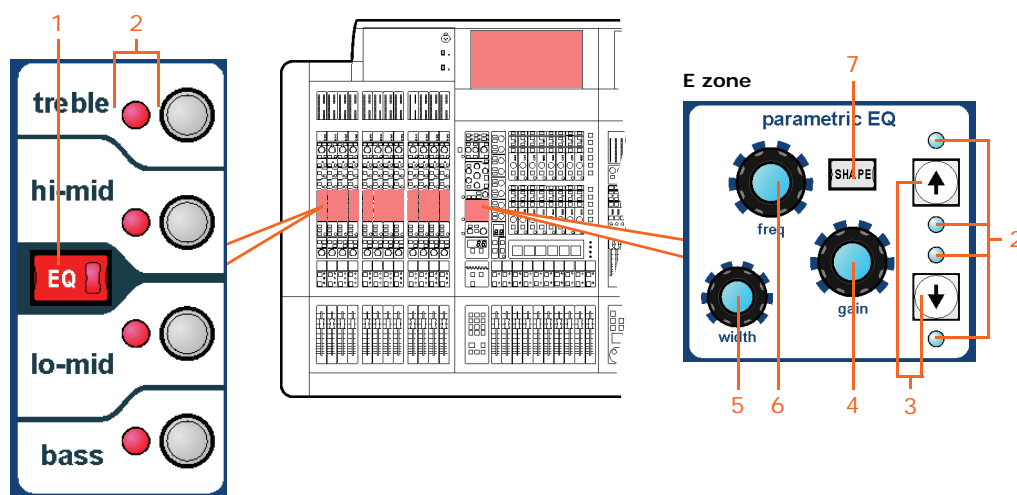

EQ controls for the input channels on the control surface and GUI

Item	Element	Description
1	EQ switch	Switches EQ on/off.
2	LEDs	Red/blue EQ on/off status indicators, illuminate when their associated band is contributing to the EQ'd sound.
3	Up/down arrow buttons	Band selection buttons, cycle through the bands, changing selection in the E zone accordingly.
4	gain control knob	Adjusts signal gain in the range -16dB to +16dB. On the graph in the EQ processing area (GUI channel strip), causes the envelope to move up/down.
5	width control knob	Adjusts the signal bandwidth in the range 0.1 Oct to 3.0 Oct. On the graph in the EQ processing area (GUI channel strip), causes the base of the envelope to widen. (Not available for treble and bass shelving modes.)

Item	Element	Description
6	freq control knob	Adjusts signal frequency. The range is band-dependent (see “Main input channel functions” on page 364). On the graph in the EQ processing area (GUI channel strip), this control causes the envelope to move left/right.
7	SHAPE button	Changes shelving mode on treble and bass bands. For recommended usage, see Table 18 “Recommended band mode usage” on page 301. For a description of each mode, see “Description of the input channel EQ modes” on page 345.

In the GUI channel strip, the EQ processing area (shown below) displays all four bands simultaneously and has a graph that shows a colour-coded EQ envelope for each selected band. Here, you can view the settings of the four bands simultaneously. The GUI also shows the ranges available for each control knob and indicates the active band, which is distinguished by its cream-coloured background.

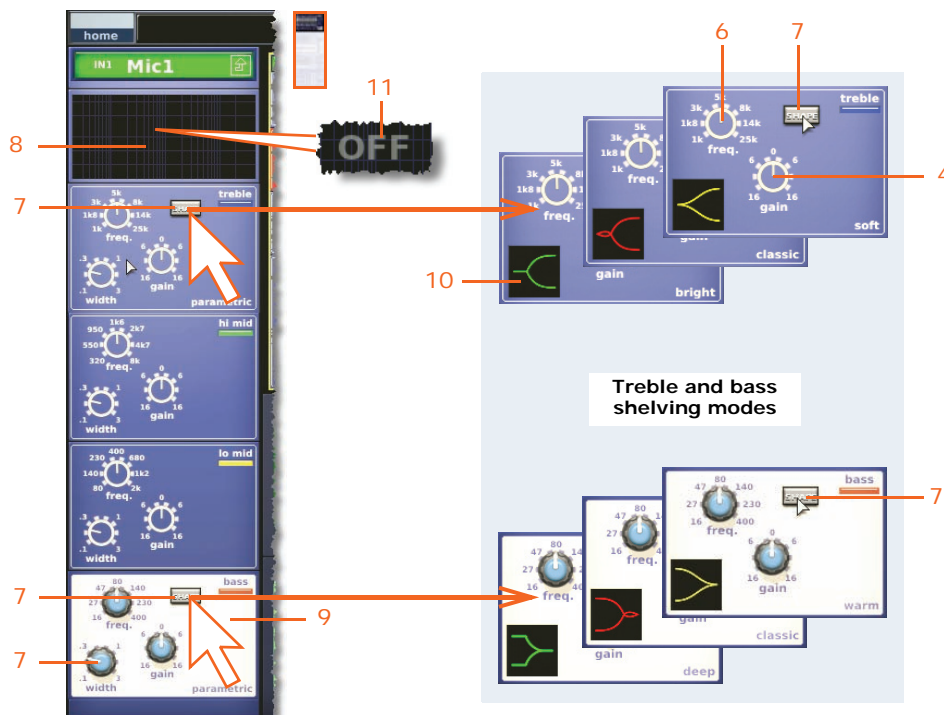

EQ controls for the input channels in the GUI channel strip. Shows the treble and bass modes, selected via the **SHAPE** buttons.

Item	Element	Description
8	Graph	Shows the EQ envelope (see “EQ graph” on page 301).
9	Bright background	Highlighted section indicates active band.
10	Icon	Represents the shape of the signal’s envelope. Note how the treble modes point to the left and the bass ones to the right.
11	Text	“OFF” is displayed when the EQ is switched off.

The following table illustrates the recommended uses of the treble and bass shelving modes.

Table 18: Recommended band mode usage

<i>Band</i>	<i>Mode</i>	<i>Best</i>
Treble	Bright	On single source material
Treble	Classic	All-round EQ
Treble	Soft	For gentle shaping of pre-mixed material
Bass	Deep	On single source material
Bass	Classic	All-round EQ
Bass	Warm	For gentle shaping of pre-mixed material

EQ graph

This section illustrates the use of the EQ **gain**, **freq** and **width** control knobs.

Gain

Adjusting the gain (**gain** control knob) changes the height of the envelope. The diagram right shows the graphs at minimum (left) and maximum gain. Note how the envelope 'flips' about the origin, which is at 0dB.

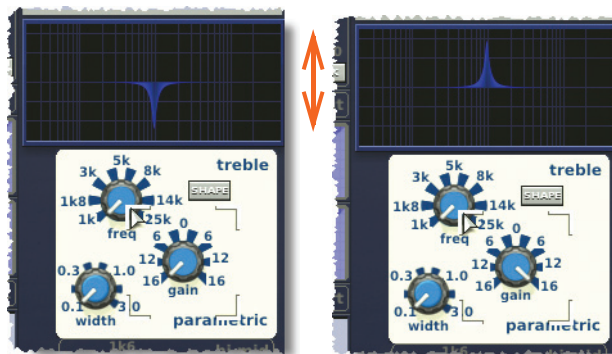

Frequency

Adjusting the frequency (**freq** control knob) changes the horizontal position of the envelope.

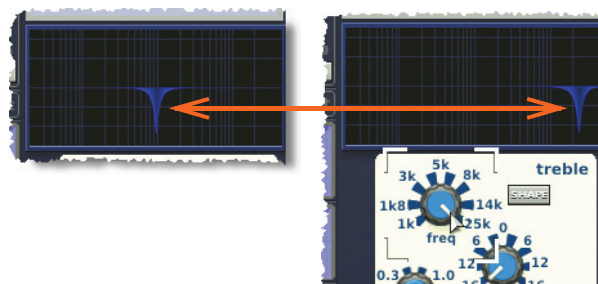

Width

Adjusting the bandwidth (**width** control knob) changes the width of the envelope.

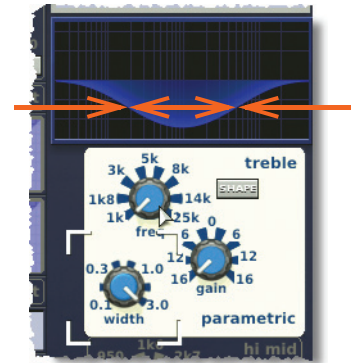
**What the graph colours represent**

Any combination of EQ envelopes for the four bands can be displayed, and each one is represented by a different colour.

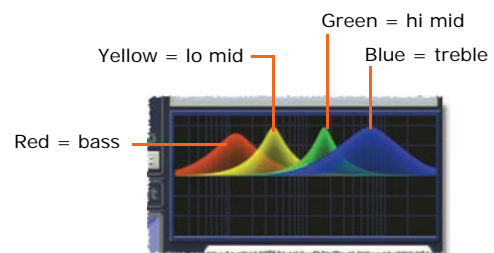

Mixes

Each input channel can send a variable contribution to each of the 16 aux buses (**aux sends**) and up to 16 matrix buses (**mtx sends**). The buses are controlled in pairs via mix controls that give continuous adjustment (in the range +6dB to off) of sub group levels sent to matrix mixes. The controls in the **mix** section (mix and master bays) include **level/pan** and **level** control knobs, whose function depends on the current bus mode in operation. When a bus pair is stereo linked, the **AFL** button (input fast strip only) is activated; although it is only enabled when you switch it on.

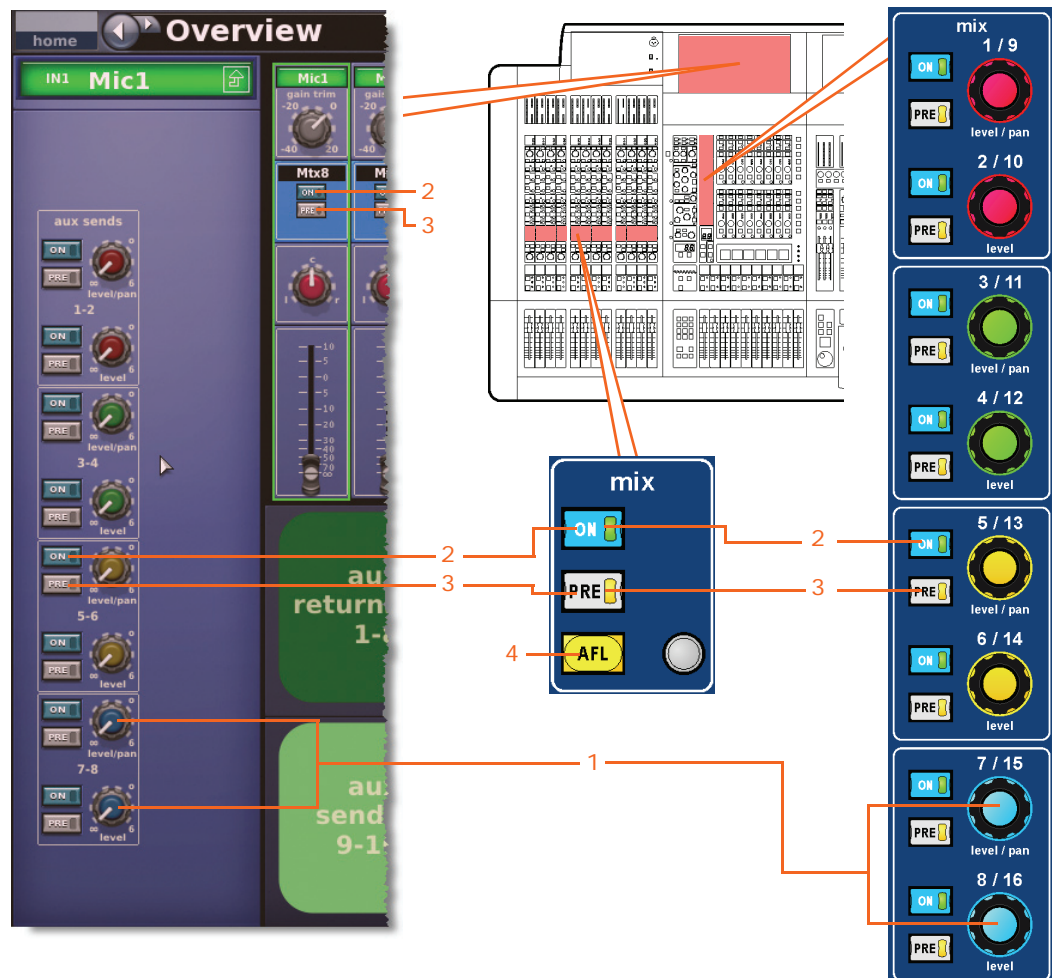

Aux and matrix mix buses for the input channels on the control surface and GUI

Item	Control	Function
1	level/pan and level control knobs	After the bus mix controls have been assigned to a mix pair, these controls offer control of relative contribution levels onto the active buses. level/pan operates odd numbered controls, while level operates the even ones. For more information, see Table 19 “Function of mix control knobs” shows their combined operation.
2	ON switches	Switch bus assignment on/off.

<i>Item</i>	<i>Control</i>	<i>Function</i>
3	PRE buttons	Change signals sent to group buses from post-fader to pre-fader. When button is on, signal is pre-fader.
4	AFL switch	This after-fade listen stereo switch, only operates on the stereo pan and level style buses and lets the user accurately place the stereo image on individual output channels.

The **mix** section — in both the mix and master bays — controls a bank of eight buses per selected input channel. While, the one in the input fast strips controls the currently selected channel bus.

In the GUI channel strip, the mix bus (sends) processing area has a similar layout to the mix section (mix and master bays).

However, the **input channel overview** gives a simultaneous display of the status of all buses. It displays the levels sent to the buses, shows which are on/off and whether they are pre- or post-fader. For details, see diagram right.

Note: Although the ramps in the diagram appear to be pixelated, this is not the case when these are viewed on the actual GUI. This is because the PRO Series GUI incorporates anti-aliasing to ensure its displays are crisp and clear.

Operators sometimes need to access main faders and multiple auxes at the same time. The 'flip' option places aux level controls onto the pan control knobs/faders (see Figure 11 "Mix bus navigational controls" on page 64).

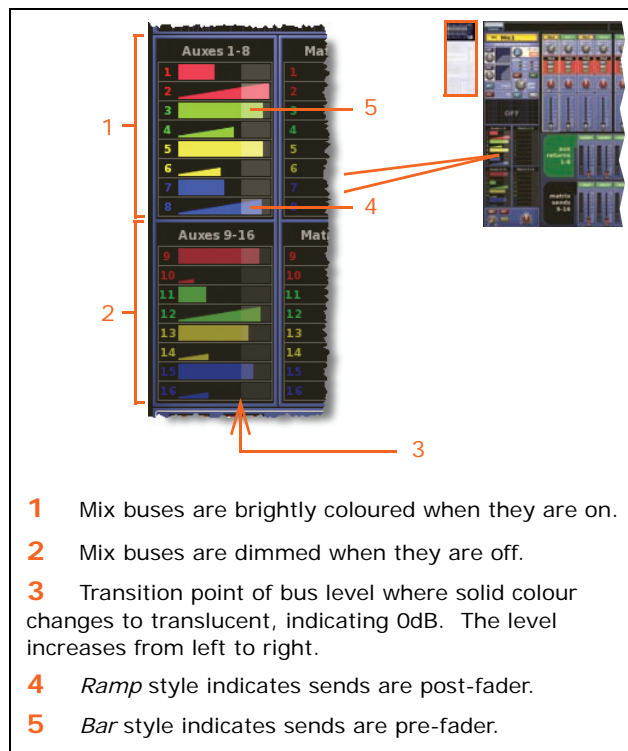

- 1** Mix buses are brightly coloured when they are on.
- 2** Mix buses are dimmed when they are off.
- 3** Transition point of bus level where solid colour changes to translucent, indicating 0dB. The level increases from left to right.
- 4** Ramp style indicates sends are post-fader.
- 5** Bar style indicates sends are pre-fader.

Desired buses are flipped using quick access buttons and the **FLIP** button. When input faders are flipped the LCD switches all change colour to match bus colour (red/yellow/blue/green) or become inverted text to indicate faders no longer function in the normal way on the main channel path.



You can edit the levels on the GUI using drag.

After selecting a bus, control is via one of the following methods:

<i>Bus type</i>	<i>Control</i>
Mono aux/matrix	Level from fader; ON and PRE active
Stereo aux/matrix	Level from fader; pan from main pan; ON and PRE active
Stereo aux/matrix	Level from fader; pan from main pan; ON and PRE active
Mono group	Post-main fader; ON active
Stereo group	Post-main fader and pan; ON active
Mono mix minus	Post-main fader; ON means 'minussed' from the bus
Stereo mix minus	Post-main fader and pan; ON means 'minussed' from the bus

Once the bus mix controls have been selected, they offer rotary control of relative contribution levels onto the buses operating as shown in the following table.

Table 19: Function of mix control knobs

<i>Bus type</i>	<i>level/pan control knob function</i>	<i>level control knob function</i>	<i>Description</i>
Mono	Level	Level	Independent left and right level adjustments (both +6dB to OFF). With ON and PRE switching (plus LED indication).
Stereo	Pan	Level	Pan adjustment is constant power law at -3dB. Level adjustment is continuous (+6dB to OFF). With ON and PRE switching (plus LED indication).
Subgroup	N/A	N/A	Both levels are disabled. 0dB only for group buses, mix and main buses. With ON switching (plus LED indication).

Master controls, solo/mute and fader

Towards the bottom of each input fast strip are the **masters** section and pan control, LCD select button, mute and solo, and the input fader.

Masters sections and pan control

The masters controls have extensive support on both the control surface and the GUI. In general, there are three routing switches to the master buses and also pan control. Pan provides master panning as three-way or two-way (depending on SIS™ setting) and also provides two-way panning for any stereo mix groups, subgroups etc. (When used for monitor applications, aux, mix and main buses are controlled from the channel master pan and fader. AFL solos also operate as a default from the main solo switch.)

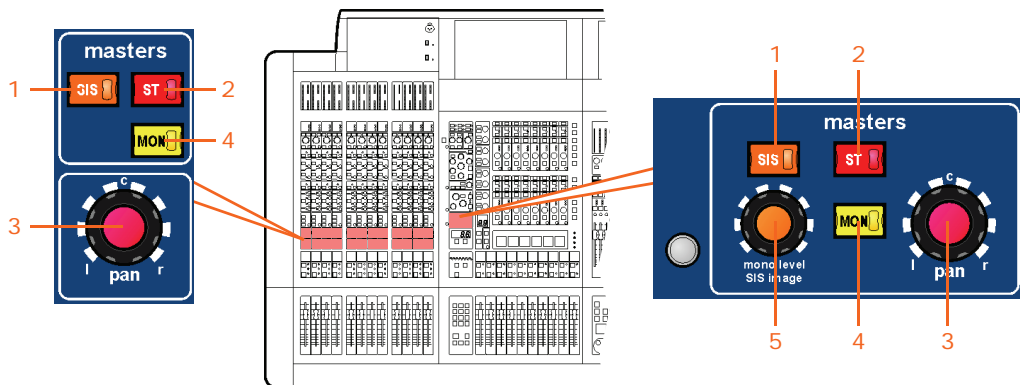

Masters and pan controls for the input channels on the control surface

Item	Control	Function
1	SIS switch	This spatial imaging system (SIS) switch, enables SIS™ mode. This mode operates with the pan and mono level/SIS image control knobs, and acts as an LCR master bus enable, overriding stereo and mono master bus assignments. However, their status remains in memory, so that when SIS is disengaged, the mono and stereo settings can return. Pressing SIS alters the gradations of the mono level/SIS image control knob on the GUI.
2	ST switch	This stereo switch connects post-fader channel signal to master stereo bus via pan control.
3	pan control knob	Adjusts the relative levels sent to a left-right bus pair or the master left-centre-right (LCR) buses. In SIS™ mode, it can also control the 'image' to give a constant power crossfade from LCR to stereo.
4	MON switch	This mono switch connects post-fader channel signal to mono master bus.
5	mono level/SIS image control knob	In mono mode, this dual-function control knob acts as a mono level control knob to adjust the mono signal level. In SIS™ mode, it becomes a SIS image control knob that modifies pan control knob operation to place the channel within a three-speaker system (see "Stereo panning" on page 131).

On the GUI, a masters section — similar to the **masters** section in the channel strips — is at the bottom of the **input channel overview** (GUI channel strip). From here, you can open the masters processing area, which also has a masters section with the same functionality, and in addition has mute and solo buttons, and a fader.

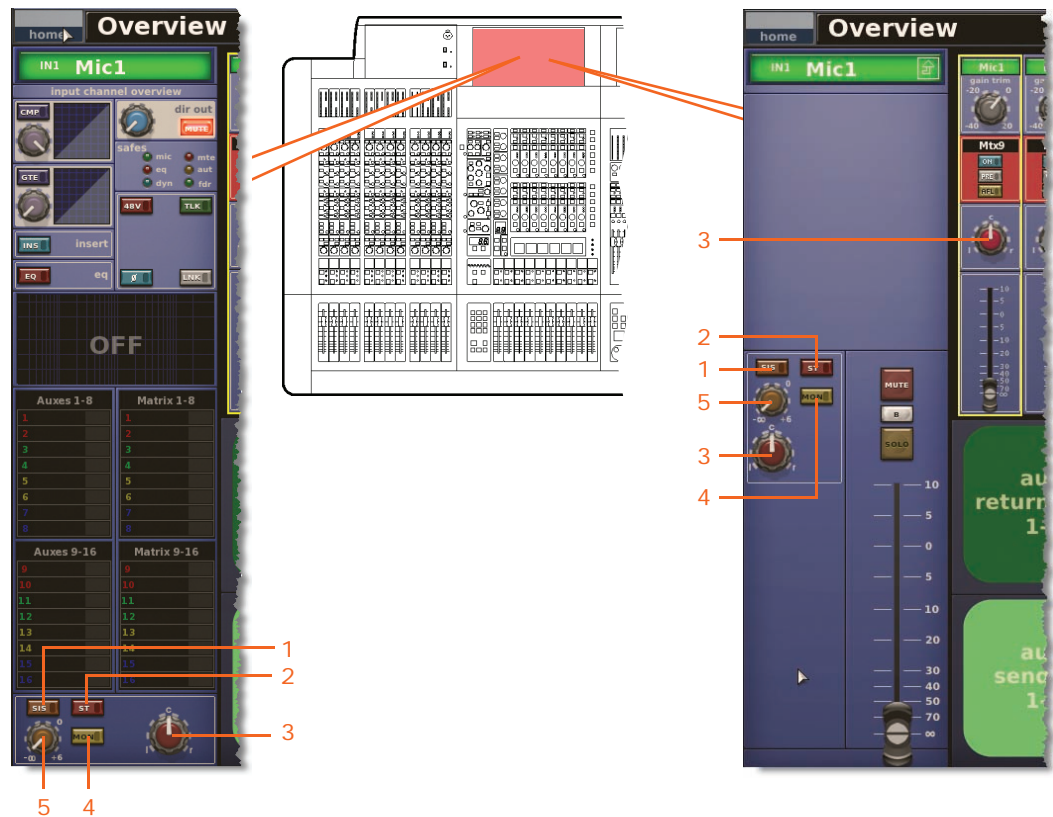

Input channel masters controls on the GUI

For more details, refer to “Stereo panning” on page 86 and “Spatial imaging system (SIS™)” on page 313.

LCD select button

The LCD select buttons in the input fast strips are used for input channel navigation and group selection. They also provide useful feedback for the user.

For more information on navigation, see “Navigating the input channels” on page 59.

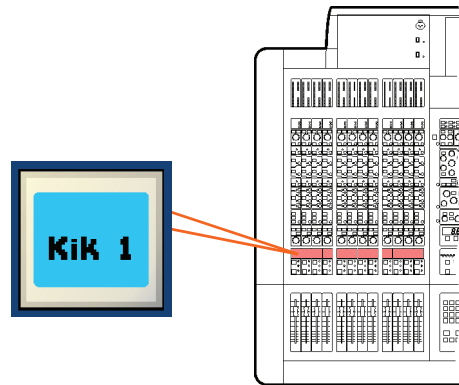

Mute, solo and safes

This section contains the **MUTE** and **SOLO** buttons, and three safe LEDs (**mute safe**, **auto safe** and **fader safe**).

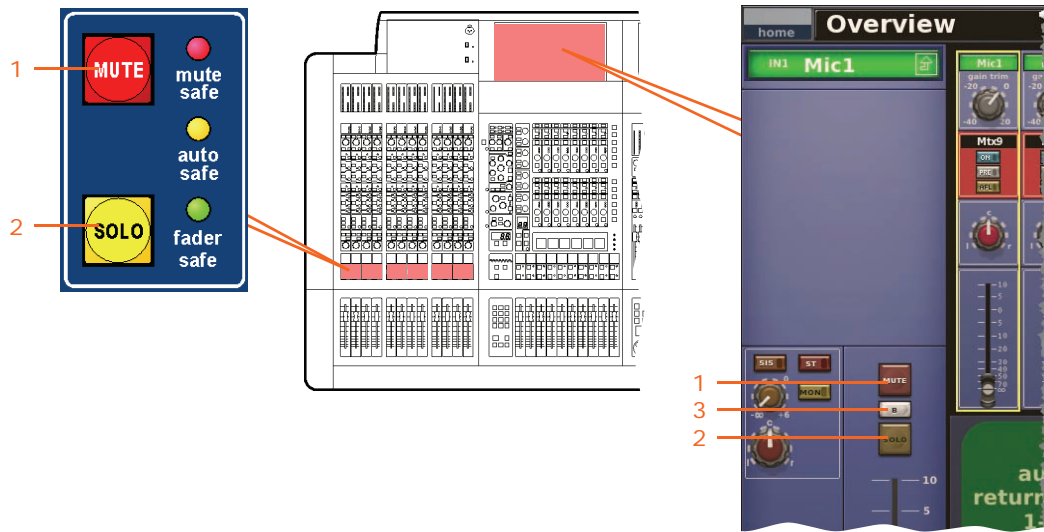

Mute, solo and safes for the input channels on the control surface and GUI

Item	Control	Function
1	MUTE button	Mutes all post-processing signals exiting the channel. In addition to scene recall, it can also be remotely muted from the auto-mute masters.
2	SOLO button	Activates signal routing to the monitor A section of the control centre by sending the input channel signal to PFL mono and AFL stereo buses. The solo system is auto-cancelling, so that each new solo cancels the last one. Input solos override any active VCA solos. This button is a latching type. Give a short press to latch it and a long press to self-connect when it is released.
3	B button	This solo button (GUI only) changes the operation of the SOLO switch so that it routes signals to the monitor B section of the control centre.

Fader

Each input fast strip has a motorised fader, which is replicated in each input fast strip on the GUI and also in the masters processing area (GUI channel strip). The fader controls the channel signal level and provides instant feedback of level settings.

The fader in the input fast strips of the 12-channel input bay can also provide level control and feedback for aux and matrix bus contributions in flip mode.

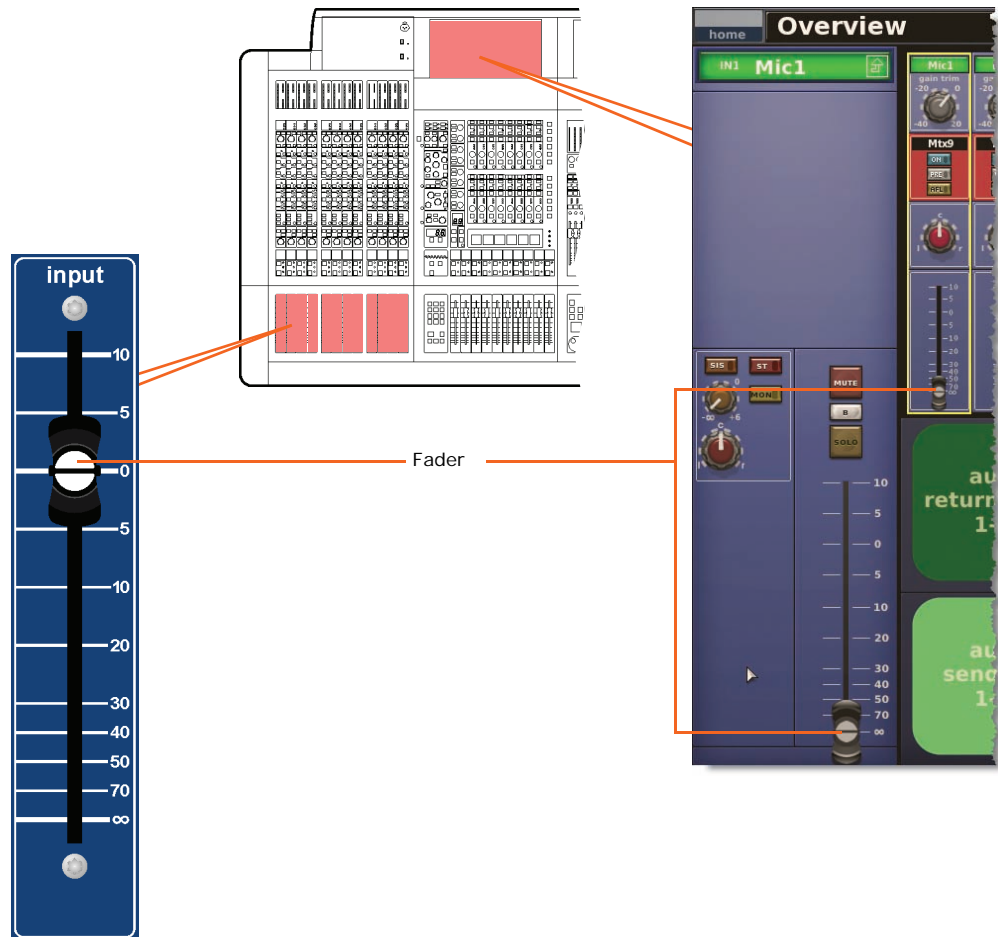

Input channel faders on the control surface and GUI

Chapter 31: Outputs

This chapter shows you the areas on the control surface that are used to manage the outputs and also describes their function. There are four type of output: auxes, returns, matrices and masters.

The structure of this chapter is loosely based on the signal path of the output channels and also the processing areas, which are opened via the output channel overview displays in the GUI channel strip.

Output channel routing

The following table shows the approximate signal path of each output type.

<i>Channel controls</i>	<i>Aux</i>	<i>Return</i>	<i>Matrix</i>	<i>Master</i>
Configuration	See page 327	See page 327	See page 327	See page 327
Direct input	See page 328	N/A	See page 328	See page 328
*#Dynamics (dual compressor)	See page 320	N/A	See page 320	See page 320
Insert	See page 329	N/A	See page 329	See page 329
*EQ	See page 321	N/A	See page 321	See page 321
Mixes	Matrix sends only (see page 329)	Matrix sends only (see page 329)	N/A	N/A
Master controls, solo select and fader	See page 330	N/A	See page 330	See page 330

* Order can be swapped (see "Processing order" on page 329).

Includes side chain section.

Output channel areas on the control surface

The mix and master bays house the areas on the control surface pertaining to the outputs (see diagram below).

The mix bay houses the output fast zone, which contains two banks of output fast strips. This bay also contains a channel strip, mix (sends) section and navigation area, which are replicated on the master bay.

The GUI has a similar configuration to the control surface, whereby the GUI screen in the mix bay has an output fast zone, and both GUI screens have a channel strip.

In general, operation of the outputs is via the mix bay, although this is configuration dependent.

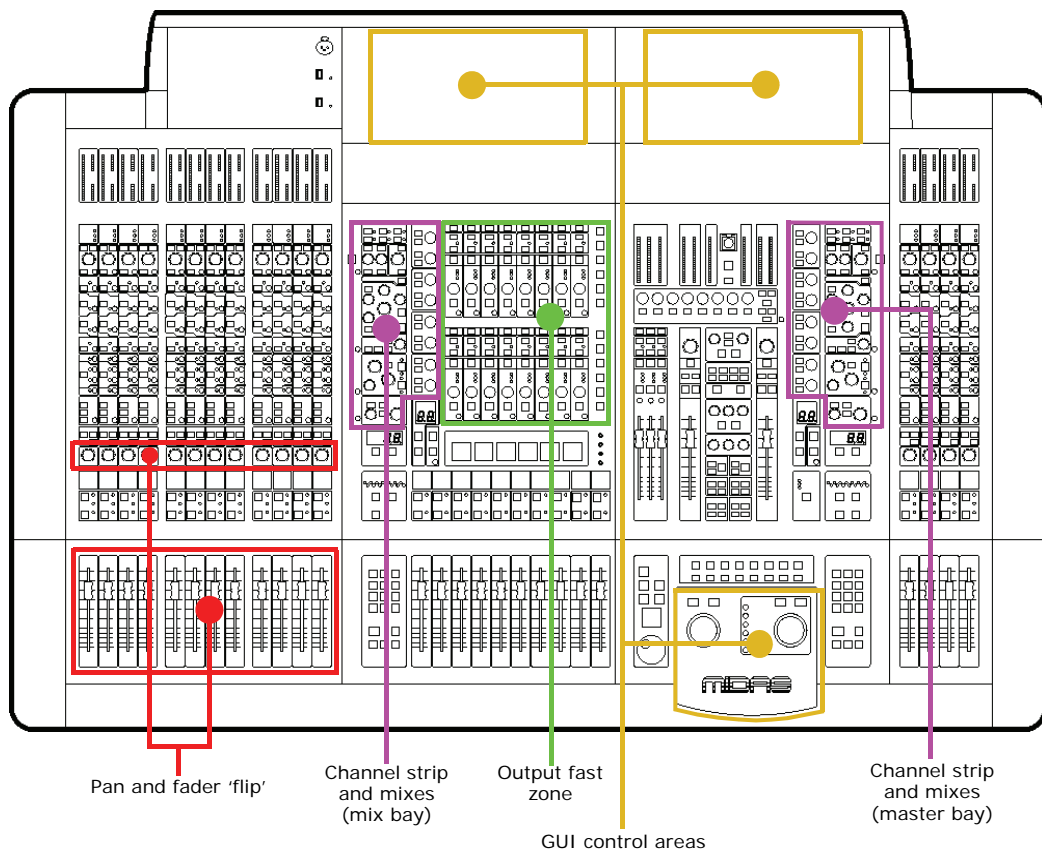

Areas on the control surface concerned with the output channels

Output fast strips, channel strips and mix buses

While the output fast strips on the control surface provide only limited control, this is greatly enhanced by the channel strip.

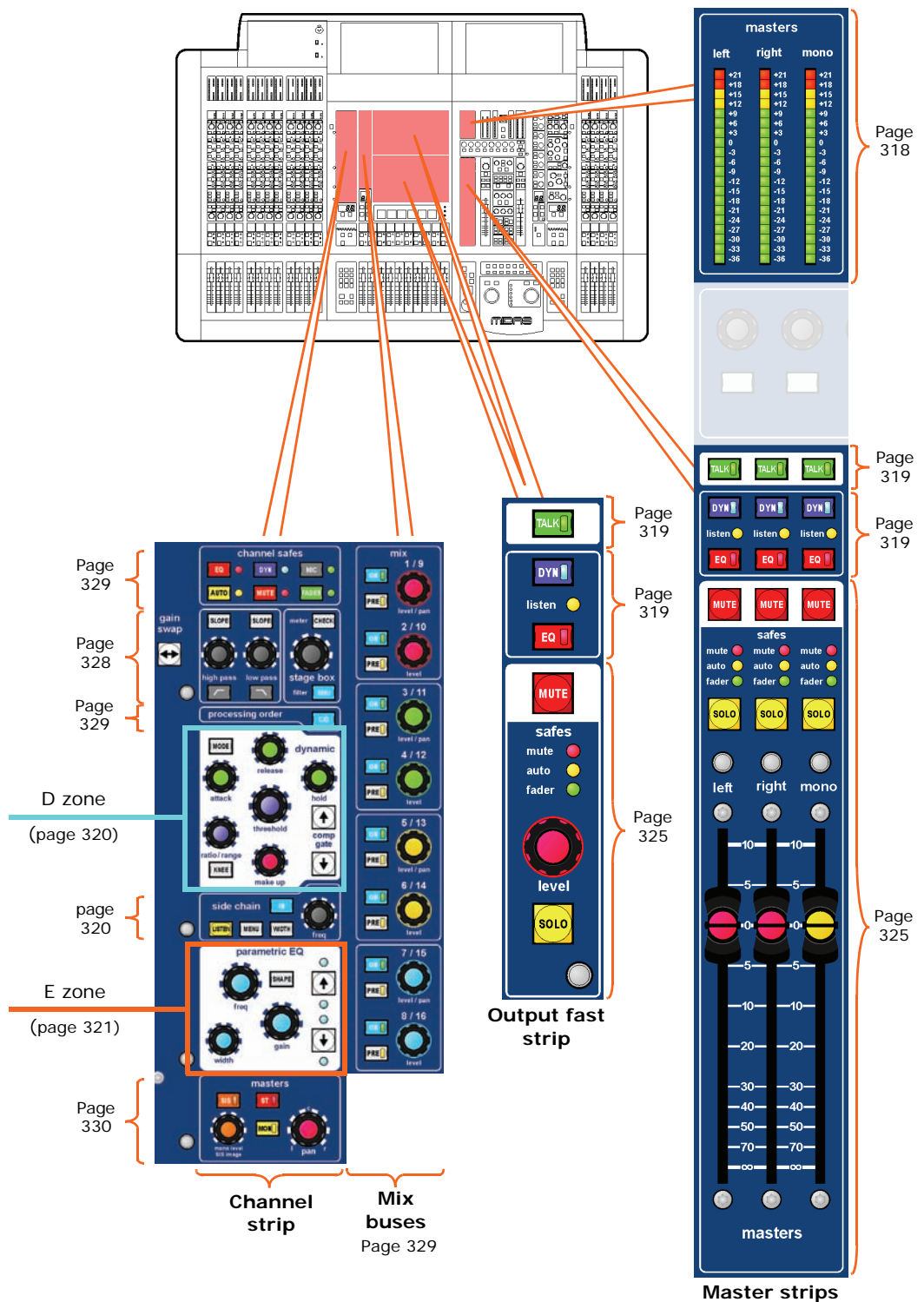

Outputs on the GUI

On the GUI, the output fast zone (mix bay only) merely provides feedback, such as signal level, solo on/off status etc., whereas the output 'overview' displays (for each output) in the channel strips provide limited control. Detailed control is provided by the processing areas.

Only the **Overview** GUI screen (default) contains output fast strips (see "GUI" on page 30).

Output fast zone (Overview screen)

The lower-right corner of the **Overview** screen has two rows of output fast strips. Each row displays a bank of eight outputs, of which there are three types (aux, return and matrix).

On the GUI, output bank selection is via a column of buttons to the right of both banks, which replicate the ones on the control surface's mix bay (to right of outputs).

As the two rows are independent of each other, you can assign the same bank to both of them.

For details of the contents of each output fast strip, see "Mute, safes, level and solo" on page 325.



PRO6 and PRO9



PRO3

GUI channel strips

Similarly to the inputs, when an output channel is selected, its 'overview' appears in the GUI channel strip, as illustrated in the figures on the following pages. These overview displays provide limited controls and status information, and give access to processing areas.

The following processing areas are available from 'overview' displays in the GUI channel strip.

<i>Channel controls</i>	<i>Aux</i>	<i>Return</i>	<i>Matrix</i>	<i>Master</i>
Insert only	N/A	Yes	N/A	N/A
Configuration only	N/A	Yes	N/A	N/A
Insert and configuration	Yes	N/A	Yes	Yes
Compressor	Yes	N/A	Yes	Yes
EQ	Yes	Yes	Yes	Yes
Buses	Yes (matrix only)	Yes (matrix only)	N/A	Yes (matrix only)
Solo, mute, safes and fader only	N/A	N/A	Yes	N/A
Masters and solo, mute, safes and fader	Yes	Yes	N/A	Yes

For details of how to navigate the GUI channel strips, see "Navigation via the GUI" on page 68.

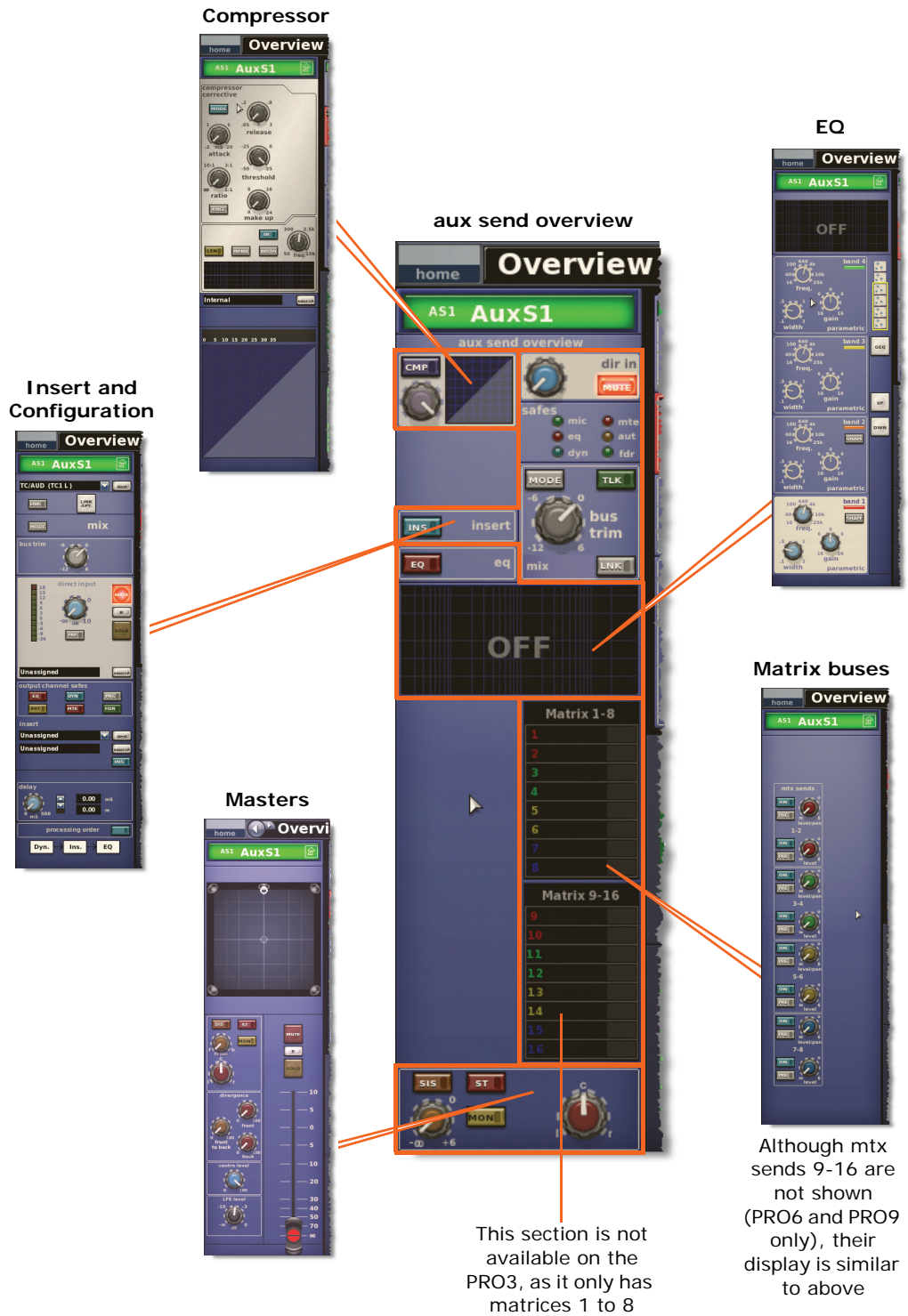

Figure 35: Processing areas available from the *aux send overview* display



Figure 36: Processing areas available from the **aux return overview** display



Figure 37: Processing areas available from the **matrix overview** display



Figure 38: Processing areas available from the **master overview** display

Output metering

Signal level monitoring of the outputs is only available on the GUI via both default screens, **Overview** and **Meters**. These screens have meters, which look similar to the ones in the input fast strips on the control surface. For more details, see "Input metering" on page 282 and "GUI" on page 30.

Talk

There is a talk switch in each output fast strip and also on the output 'overview' displays in the GUI channel strip.

If the **TALK/[TLK]** switch in the **talk mic** section is active, the talk buttons will illuminate to prompt the operator to select a bus that the talk signals should be routed to. These are also used to set up a talk group after pressing one of the **talk/osc routing** panel buttons.

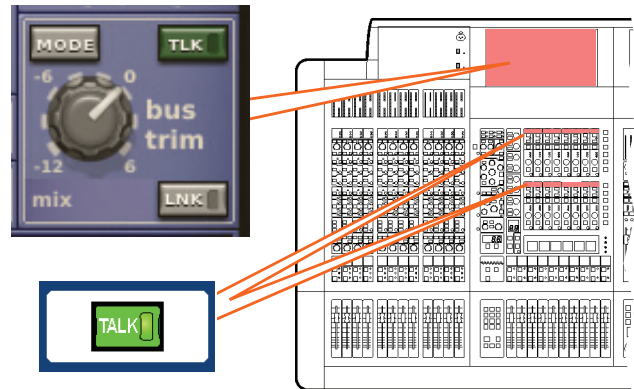

Dynamics and EQ

The control surface has a combined dynamics and EQ section that contains **DYN** and **EQ** on/off buttons, and a **listen** LED (yellow) that illuminates when listen is active in the output processing area to show when a channel has its dynamic side chain soloed.

In the GUI channel strip overview display the aux, matrix and master outputs each have a compressor section and an EQ section (both are highlighted in the diagram below). Return outputs only have an EQ section. Clicking within either of these sections will open their respective processing areas, which are described in the following subsections.

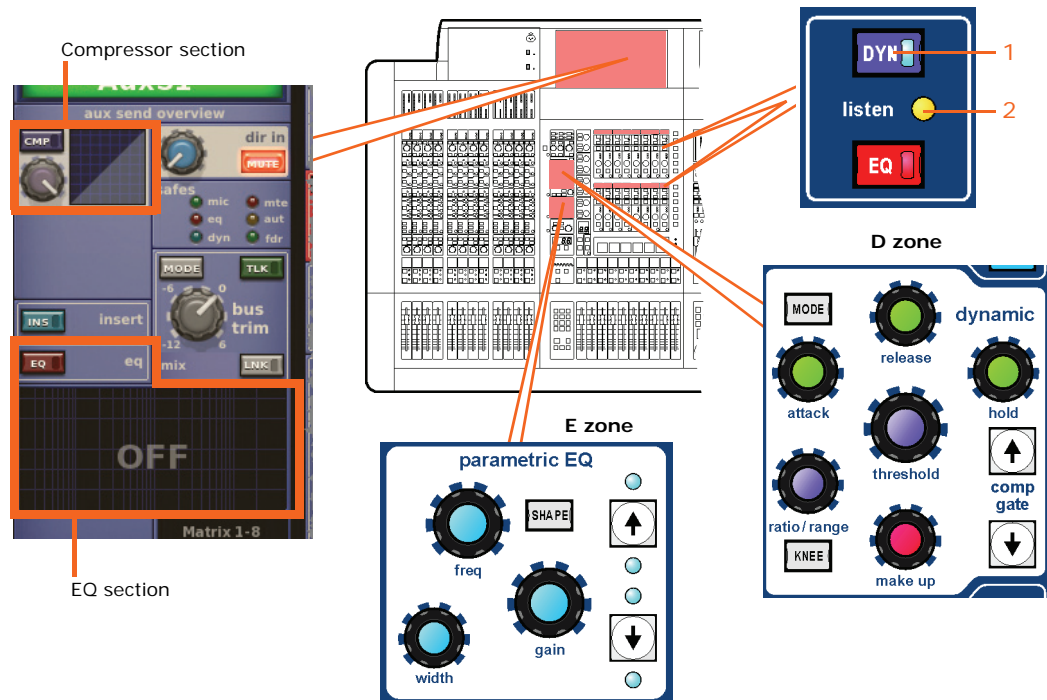

Figure 39: Dynamics and EQ areas for the output channels on the control surface and GUI

Compressor (D zone)

For the outputs, the **dynamic** section (D zone) only has a compressor in the output channel signal path. As the D zone is also used for the gate on the input channels, some controls may be redundant.

The output channel compressor has five styles — corrective, adaptive, creative, vintage and shimmer — which are selectable via the **MODE** button. Each has a distinctive appearance in the GUI channel strip. While the dynamic section is addressing the compressor, all of its controls are enabled except the **hold** control knob.

For details of the compressor graph, see “Compressor graph” on page 292.

The side chain is similar to the one used for the input channels, see “Side chain” on page 296.

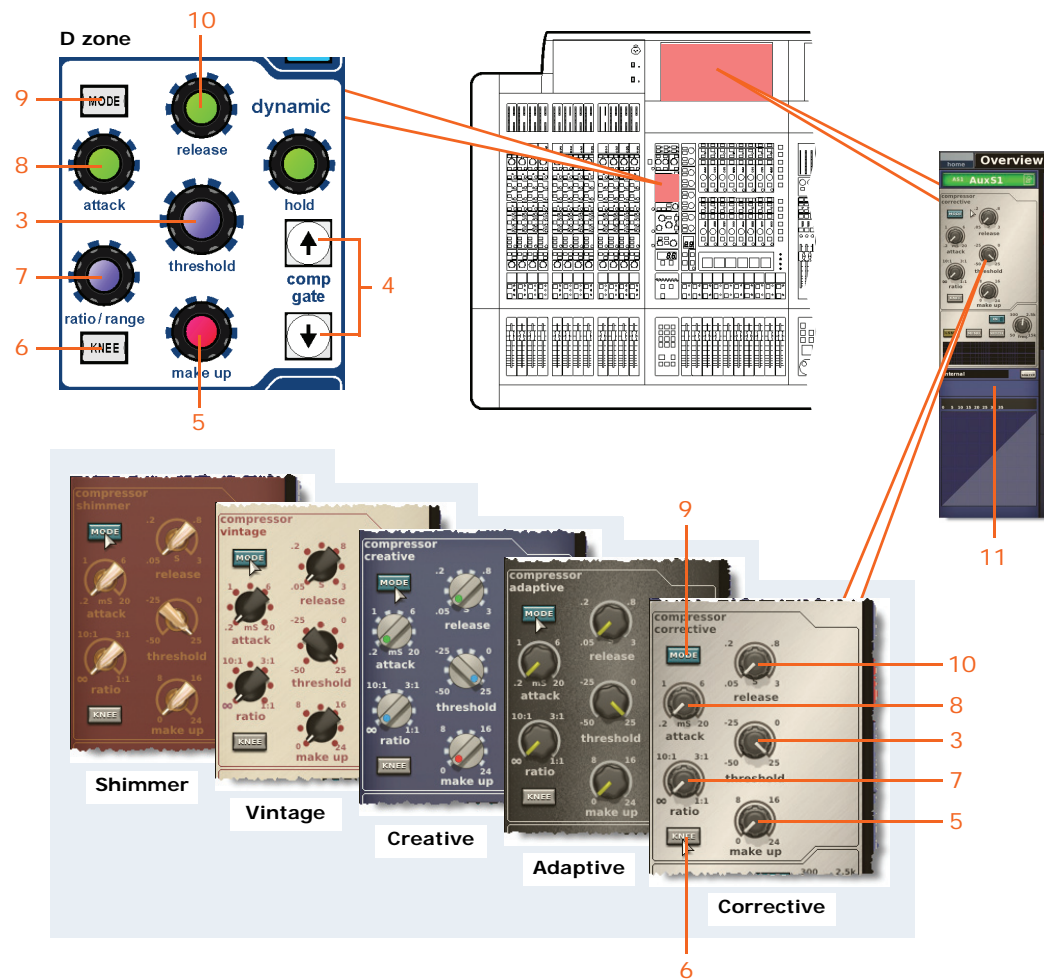

Compressor sections for the output channels on the control surface and GUI

Item	Control	Function
1	DYN switch	Enables the compressor in the signal path. When switched off, compressor is bypassed. See Figure 39 on page 319.
2	listen LED	To aid set up, the compressor has a side chain listen that sends the side chain onto a solo bus. This side chain listen LED indicator illuminates to warn you that soloed material is from the side chain, and not the main channel. See Figure 39 on page 319.

<i>Item</i>	<i>Control</i>	<i>Function</i>
3	threshold control knob	Sets the signal level above which gain reduction starts to be applied. Range is from -50dBu to +25dBu.
4	comp/gate up/down select buttons	These select buttons swap dynamic section control from compressor to gate, and the reverse.
5	make up control knob	This compressor gain control compensates for the reduced <i>loudness</i> of a compressed signal. Range is from 0dB to 24dB.
6	KNEE switch	This compressor control controls how compressor starts to apply gain as the signal goes through the threshold (see “Compressor graph” on page 292). For more information, see Table “Compressor graph” on page 292 and “Knee” on page 342.
7	ratio/range/ [ratio] control knob	This compressor control adjusts the amount of compression applied to signals above threshold. Range is from infinity (∞) to 1:1. When set to maximum (1:1), sets compressor to limiter mode.
8	attack control knob	This compressor control adjusts the time it takes the compressor to respond after an over-threshold signal. Range is from 0.2ms to 20ms (milliseconds).
9	MODE switch	Selects compressor mode from the five compressor types available (see “PRO Series compressor modes (dynamic)” on page 341).
10	release control knob	This compressor control adjusts the time it takes the compressor to recover after programme material falls back below threshold. Range is from 0.05s to 3.00s (seconds).
11	Meter	Compressor ‘gain reduction’ meter.

EQ (E zone)

For tonal control of the aux, matrix and master output signals, the output channel EQ has the option of a six-band sweep parametric EQ (PEQ) or an assignable graphic EQ (GEQ).

PEQ

The parametric EQ section (E zone) of the channel strip (mix and master bays) allows tonal control of the input signal. The E zone contains all of the PEQ controls, along with a shelving mode selection button and another set of band selection buttons.

All of the outputs, except returns, have six-band PEQs. Two of the six bands have three shelving modes each, while another has just one. Any combination of the six bands can be used to control the signal, although only one band can be adjusted in the E zone at any time. However, the EQ processing area (GUI channel strip) displays four bands at any time, and also has navigational controls.

The returns have a four-band PEQ, which is similar to that used on the inputs. For information, see “EQ (E zone)” on page 299.

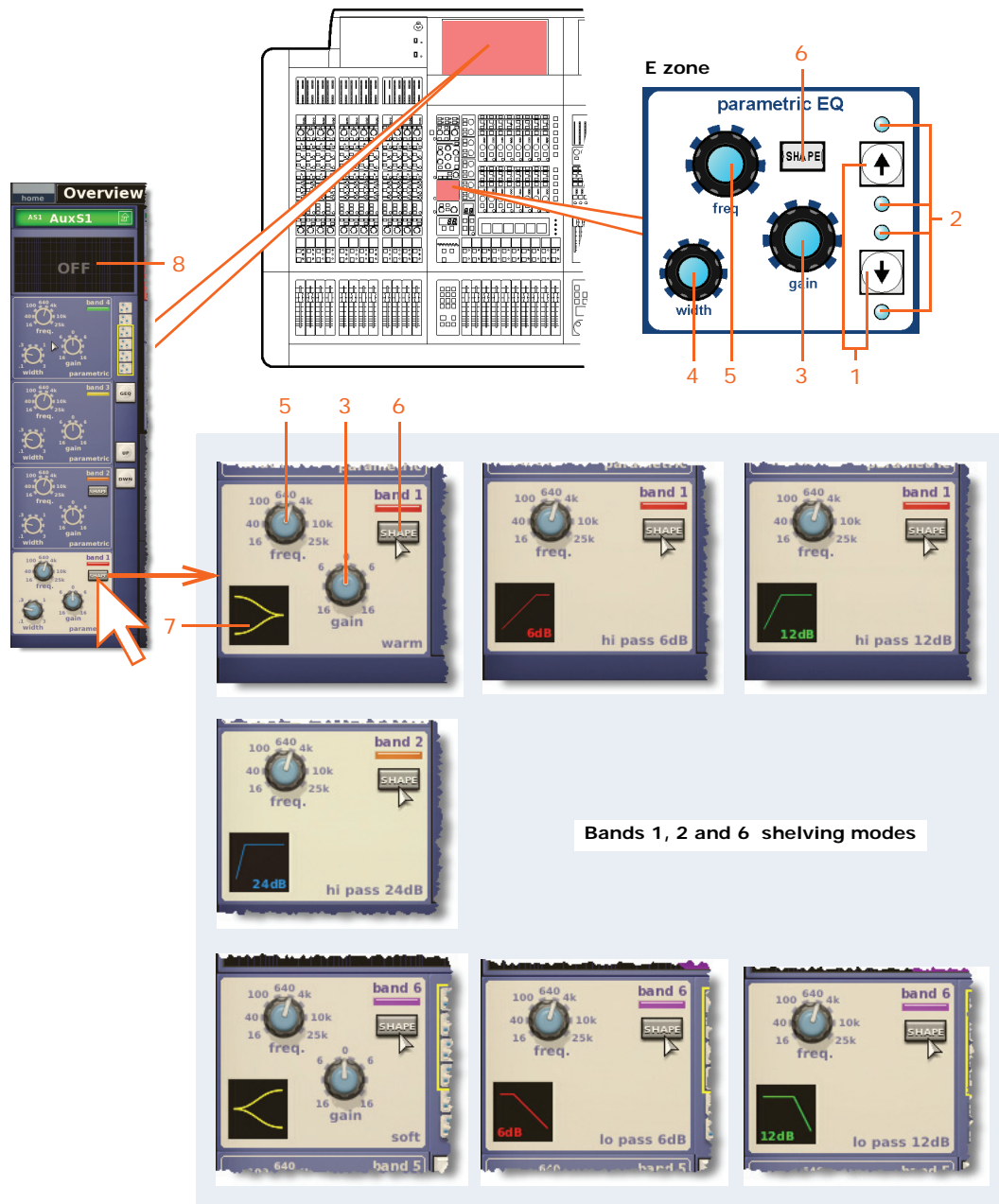

PEQ sections for the output channels on the control surface and GUI

Item	Control	Function
1	Up/down buttons	These are band navigation buttons (see “Navigating the PEQ output bands” on page 324). They are also used in conjunction with the blue adjacent LEDs to show which band is currently selected. Illuminated up arrow means that band 5 is selected, and illuminated down arrow means that band 2 is selected.
2	LEDs	These four blue LEDs illuminate to show the current band selection. Used in conjunction with the up and down buttons, they show — from the bottom LED upwards — when band 1, 3, 4 or 6 is selected.

Item	Control	Function
3	gain control knob	Adjusts signal gain in the range -16dB to +16dB. On the graph in the EQ processing area (GUI channel strip), causes the envelope to move up/down, inverting as it passes the origin.
4	width control knob	Adjusts the signal bandwidth in the range 0.1 Oct to 3.0 Oct. On the graph in the EQ processing area (GUI channel strip), causes the base of the envelope to widen. (Not available for shelving modes.)
5	freq control knob	Adjusts signal frequency. The range is band-dependent (see "Main input channel functions" on page 364). On the graph in the EQ processing area (GUI channel strip), causes the envelope to move left/right.
6	SHAPE button	Changes the shelving mode on treble and bass bands. For a description of each mode, see "Description of the output channel EQ modes" on page 347.
7	Shelving symbol	Diagrammatic representation of the shelving envelope.
8	Graph	EQ envelope graph (see "EQ graph" on page 325). When "OFF" is displayed, EQ is switched off.

GEO

The GEO is similar to the ones found in the **Graphic EQs** screen and can also be operated using the assignable controls. For information, see Chapter 15 "Graphic Equaliser (GEO)" on page 157.



>> To open the GEO window

- 1 Select the output. Its 'overview' display will appear in the channel strip.
- 2 In the GUI channel strip, open the EQ processing area (see "To select a processing area" on page 63).

- 3 Click **GEQ.** in the processing area.

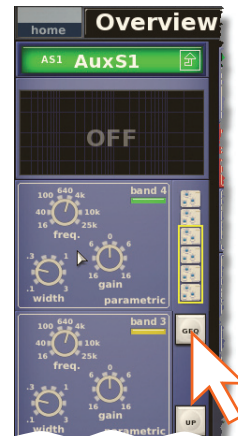

- 4 Click a non-control area of the GEQ image (shown right) to open the GEQ window.

>> **To close the GEQ window**

In the GEQ window, click **CLOSE.**

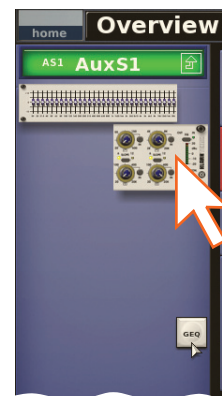

Navigating the PEQ output bands

You can change band selection by clicking the **UP/DOWN** buttons in the EQ processing area. This will change selection by one band at a time.

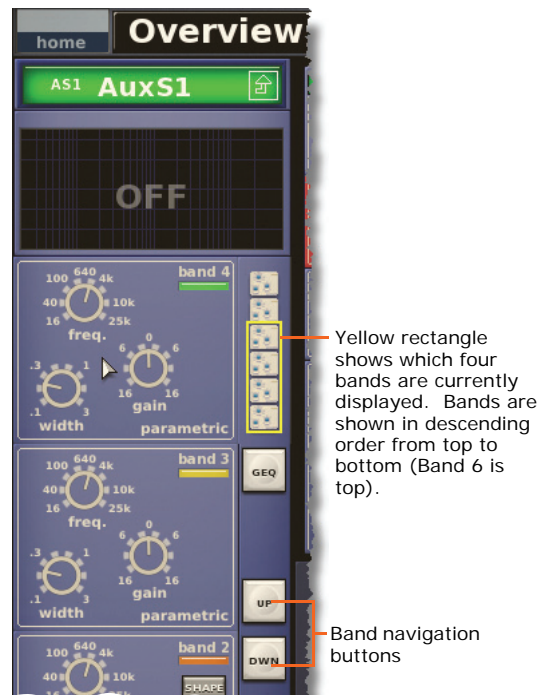

EQ graph

The controls in the output EQ sections, that is, the EQ **gain**, **freq** and **width** control knobs, have a similar functionality to the ones in the input EQ sections. For details, see "EQ graph" on page 301.

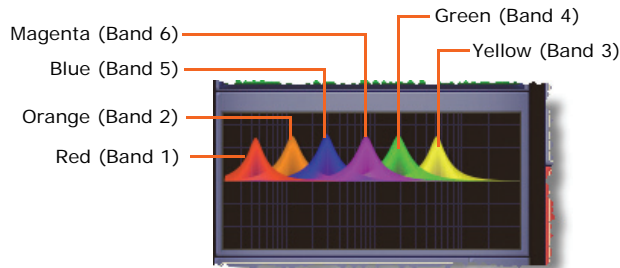

EQ graph containing all six bands

Mute, safes, level and solo

Each output fast strip (control surface and GUI) has controls for muting, soloing, safes and output signal level control. This is supported on the GUI in the appropriate processing area. In addition, the channel strips (control surface and GUI) have the full complement of safes.

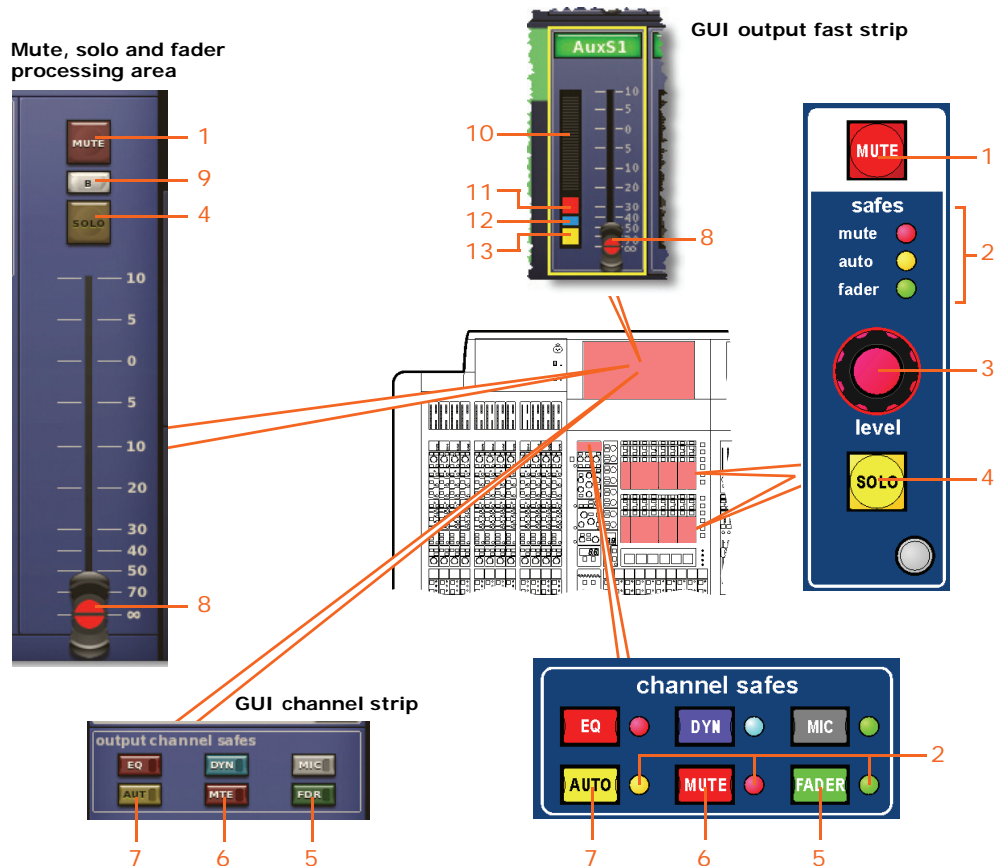

Mute, safes, level and solo areas for the output channels on the control surface and GUI

<i>Item</i>	<i>Control</i>	<i>Function</i>
1	MUTE switch	Mutes all post-processing signals leaving the channel. (In addition to scene recall, muting can be remote from the auto-mute masters.)
2	LEDs	These safe LEDs illuminate when their associated safe is on.
3	level control knob	Adjusts the output signal level. In the masters section (master bay), this is a fader.
4	SOLO switch	Activates signal routing to the monitor A section of the control centre.
5	FADER/[FDR] switch	Switches fader safe on, so that the fader is removed from scene recall.
6	MUTE/[MTE] switch	Switches mute safe on, so that mute is removed from the scene recall and auto-mute action.
7	AUTO/[AUT] switch	Switches auto safe on, so that the channel is removed from scene recall (this does not affect the action of the auto-mutes and VCA control groups) and control is removed from VCA control group faders.
8	Fader	Adjusts output signal level. Has the same function as the level control knob (see item 3).
9	B switch (GUI only)	This solo B switch changes the operation of the SOLO switch so that it routes signals to the Monitor B section of the control centre.
10	Meter	Output signal level meter.
11	Red on/off indicator	Illuminates when mute is on.
12	Blue on/off indicator	Illuminates when solo B is on.
13	Yellow on/off indicator	Illuminates when solo on.

Output channel configuration controls

There are a number of output channel controls that are loosely termed 'channel configuration' controls. The following table shows the configuration controls available on each output and references the pertinent section within this chapter.

Table 20: Output channel configuration controls

<i>Channel controls</i>	<i>Aux</i>	<i>Return</i>	<i>Matrix</i>	<i>Master</i>	<i>Refer to</i>
Output channel ID	Yes	Yes	Yes	Yes	Page 327
Output channel source/destination	Destination	Source	Destination	Destination	Page 327
Stereo linking	Yes	Yes	Yes	Yes	Page 328
Gain swap	N/A	Yes	N/A	N/A	Page 328
Mix	Yes	N/A	N/A	N/A	Page 328
Input mode	N/A	Yes	N/A	N/A	Page 328
Link fader	N/A	N/A	Yes	N/A	Page 328
Bus trim	Yes	N/A	Yes	Yes	Page 328
Direct input	Yes	N/A	Yes	Yes	Page 328
Safes (EQ, dynamics, mic, auto, mute and fader)	All six	Five only (excluding dynamics)	All six	All six	Page 329
Insert	Yes	N/A (on separate processing area)	Yes	Yes	Page 329
Delay	Yes	N/A	Yes	Yes	Page 329
Processing order	Yes	N/A	Yes	Yes	Page 329

Output channel ID (GUI only)

You can change the channel name in the GUI channel strip. This can be done in the output channel overview or in any of the processing areas.



To change the background colour of the output channel name field (green in the example shown) and/or the channel name, open the **Output Channels Sheet** screen of the GUI menu.

>> To change the channel name in the GUI channel strip

Click within the channel name field and type in the new channel name (see "Text editing" on page 57).

Output channel source/destination (GUI only)

The channel's destination is shown in the text field of the configuration processing area. If no destination has been selected, it will contain the text "Unassigned" (as shown right).

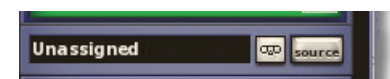

You can select the destination for this channel by clicking **dest**, which opens the **Patching** screen (see Chapter 8 "Patching" on page 71). For routing information, see Table 25 "Navigating to the Patching screen" on page 418.

By clicking the recorder button  (returns only) you can set the input source to tape returns.

Stereo linking (GUI only)

The linking section of the configuration processing area has a **LNK** switch for linking the selected output channel to the adjacent (higher numbered) output channel. The **LINK OPT.** button opens a **Stereo Linking Options** window from where you can select the linked parameters. For more information, see Chapter 10 "Stereo Linking" on page 127.

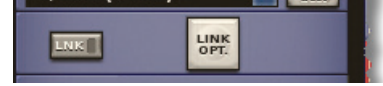

Gain swap (GUI only)

Only return has the gain swap facility. Clicking **GAIN SWAP** swaps from remote (stage box) gain to digital trim (console gain), and vice versa. For more information, see "Mic amp input gain (preliminary input processing)" on page 286.



Mix mode (GUI only)

The **mix** section (aux only) has a **MODE** button for scrolling through the three mix modes, that is, mix, mix minus and group.

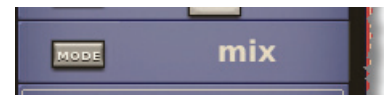

Input mode (GUI only)

The button in the **input mode** section (return only) time aligns the return channel with the input channels.

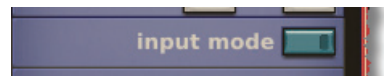

Fader linking (GUI only)

The **link fader** section (matrix only) has **ST** and **MON** buttons for linking the matrix channel fader to the stereo or to the mono master faders, respectively. Control of the stereo master faders reverts to the highest fader.

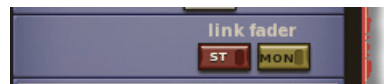

Bus trim (GUI only)

The **bus trim** section (all output channels except return) has a control for fine adjustment of the gain. Range is from -12 dB to +6 dB.

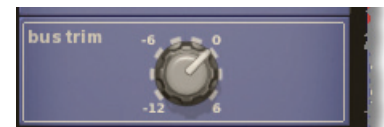

Direct input (GUI only)

The **direct input** section (all output channels except return) provides an internal connection to effects etc. or an external input into the output from an effect or line I/O unit. It lets you take a signal directly out of a defined point in the input channel's signal path and route it to either an internal assignable effect or to one of the physical outputs (a physical connection at one of the line I/O boxes). This function is optional and assigned on a channel-by-channel basis.



This section is deliberately distanced from main channel panel controls because it is a limited resource and unused on many channels.

Selection of signal path source can only be carried out via the GUI.

This section has similar functionality to the **direct output** section on each input channel, see "Direct input (GUI only)" on page 328.

For routing information, see Table 25 "Navigating to the Patching screen" on page 418.

Safes

Each output channel (except return) has six types of output channel safes that each protects a specific control/area from the automation system.

The safes on the return channel are input channel types, of which there are only five available (there is no dynamics).

You can only operate the safe switches via the channel strips (control surface and GUI), which also provide on/off status information. The status of some of the safes is displayed via LEDs in the output fast strips and master strips on the control surface.

For more information on what areas are protected by each safe, see Appendix M "Parameters Protected By Safes" on page 469.

Insert (GUI only)

You can configure the send and return points of the aux, matrix and master outputs in the **insert** section of the configuration processing area. The returns have a separate insert processing area, which has the same function.

For routing information, see Table 25 "Navigating to the Patching screen" on page 418.

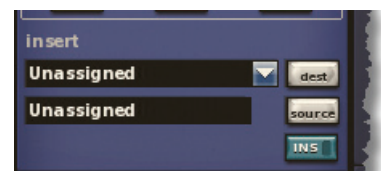

Output channel delay (GUI only)

Similarly to the input channels, all of the output channels (except returns) have a delay that can be incorporated into the signal path. However, this can be a much larger delay, being in the range 0ms to 500ms (milliseconds). For details, see "Input channel delay (GUI only)" on page 284.

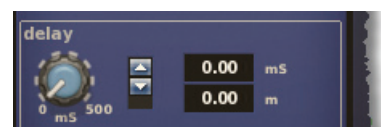

Processing order

Similarly to the input channels, you can change the processing order on all of the output channels (except returns). For details, see "Processing order" on page 288.

Mixes

Each of the aux, return and master output channels can send a variable contribution to the mixes on each of the matrix buses. The buses are controlled in pairs via mix controls that give continuous adjustment (in the range +6dB to off) of sub group levels sent to matrix mixes. The controls in the **mix** section (mix and master bays) include **level/pan** and **level** control knobs for each bus pair, whose function (auxes only) depends on the current bus mode in operation.

The mixes on the outputs are similar in functionality to inputs, except there is no after fader listen. For details, see "Mixes" on page 303.

Masters

For each output, the **masters** section (channel strip of the mix and master bays) functions in the same way as for the inputs (see “Master controls, solo/mute and fader” on page 306). The same also applies to fader (see “Fader” on page 309).

Chapter 32: GUI Menu

The GUI is a very powerful multi-functional tool that forms the core of the PRO Series Control Centre. It gives you total control and monitoring of the operating environment, enhances control surface operation (you can even operate the PRO Series by GUI-only) and allows the use of internal and external devices. To facilitate this the GUI incorporates a simple-to-use GUI menu.

The GUI menu presents you with a list of options from which to choose, depending on your requirement. The following lists some of the functions that the GUI menu provides:

- **Configuration** Configure the routing, associations and the names and colours of channels, groups, graphic EQs and internal effects, set up for multi-console operation, set up the connected devices etc.
- **Navigation** Select the channels, buses and groups you want, go quickly to a GUI screen display, go to recently opened screens, move through the scenes in a show and go to the patching screens you want.
- **Management** Manage show files (internal and external), automation and the monitoring system.
- **User and operating preferences** Adjust GUI screen brightness and contrast, select delay compensation, select fader flip etc.
- **Information** View current software information.
- **Overcoming a faulty GUI screen** Should a GUI screen fail, you can re-map it to a different bay.
- **Diagnostics** Check at-a-glance how your system is performing.
- **Security** Lock the screens to prevent unauthorised access.
- **Shutdown sequence** Shut down the control centre properly.
- **Upgrading the software** Install the very latest version (or any previous version) of PRO Series software.

For details of how to use the GUI menu, see “Using the GUI menu” on page 56.

Elements of the GUI menu

This section explains the elements that comprise the GUI menu.

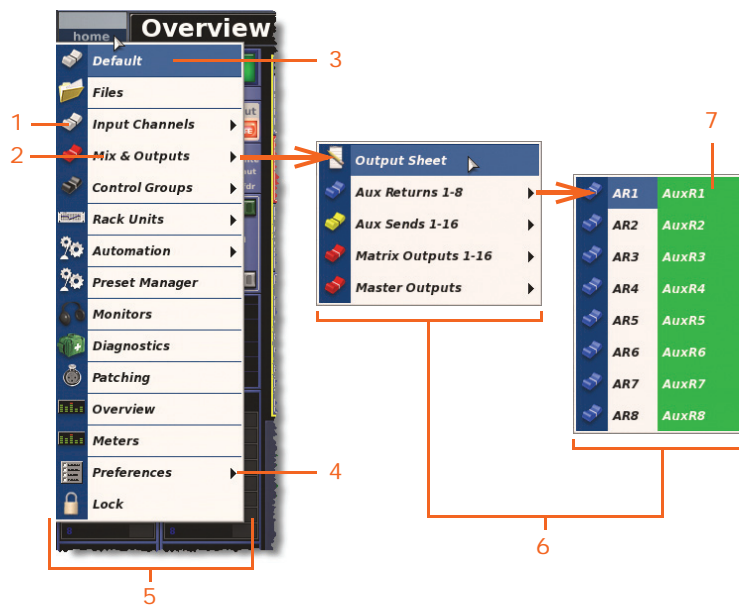

Item	Element
------	---------

- | | |
|---|--|
| 1 | A graphic that represents the function of its associated option. |
| 2 | Option name. |
| 3 | When you move the screen cursor over an option its background will change to blue to let you know that it will be selected if you click on it. |
| 4 | A right-pointing arrow at the right of an option name shows that the option has a submenu. |
| 5 | GUI main menu. |
| 6 | Submenus. |
| 7 | The background colour of each input and output channel, mix, group etc., will match its user-configured colour. (The ones in the diagram show the default colour, which is green.) |

GUI menu flowchart

The GUI menu for each type of PRO Series Control Centre (and available submenus) are shown in the following figures. Icons to the left of the options help to identify the option type and aid navigation.

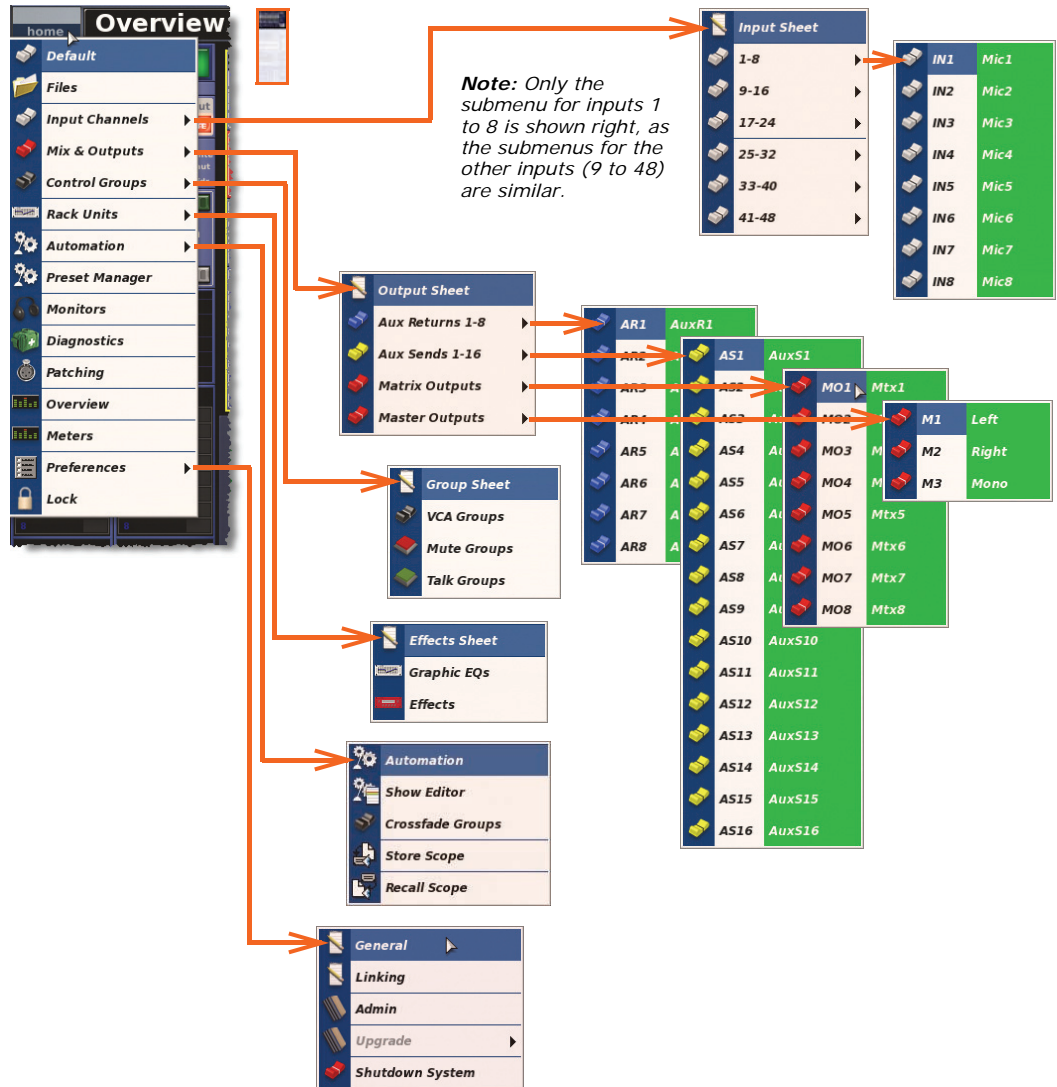

Figure 40: PRO3 GUI menu flowchart

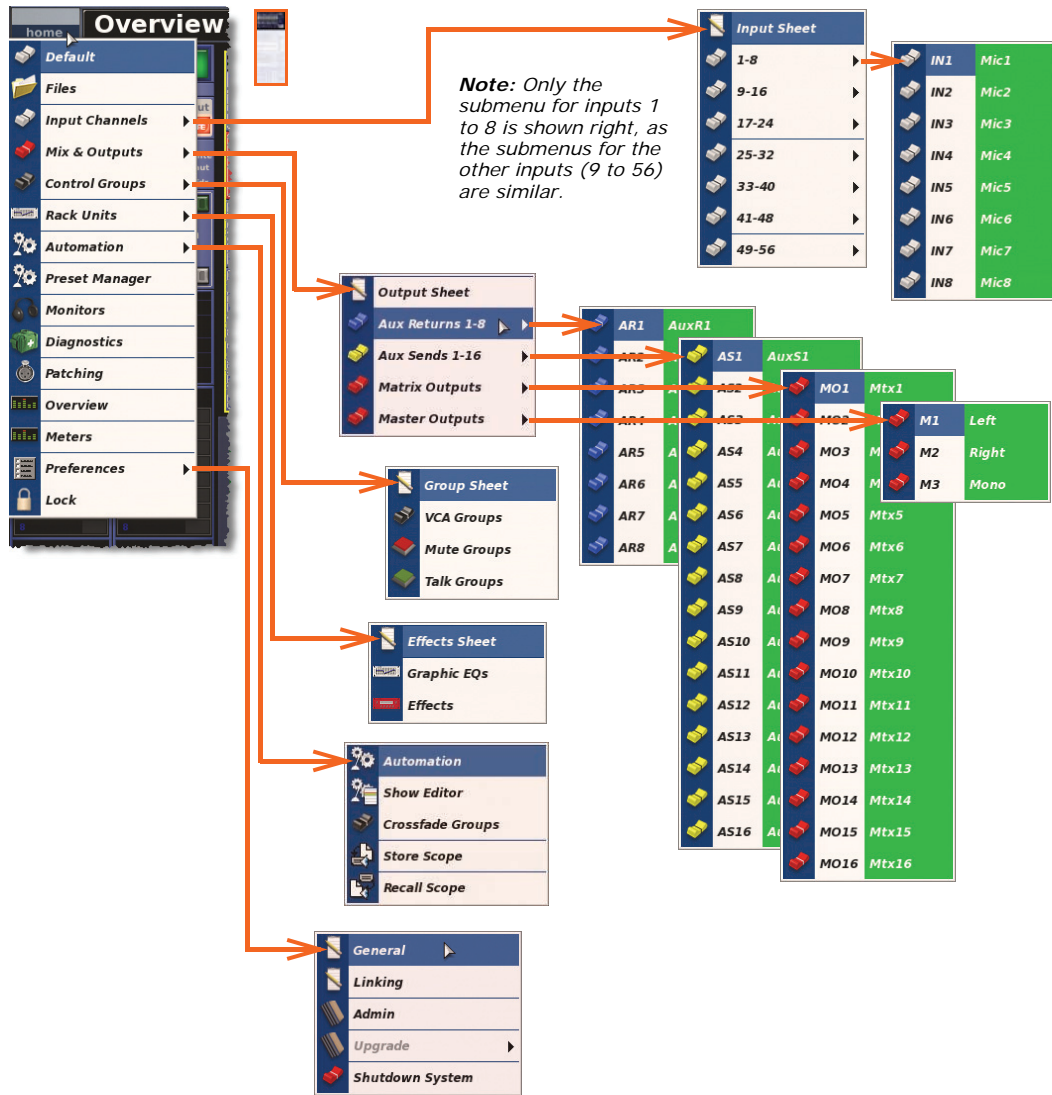

Figure 41: PRO6 GUI menu flowchart

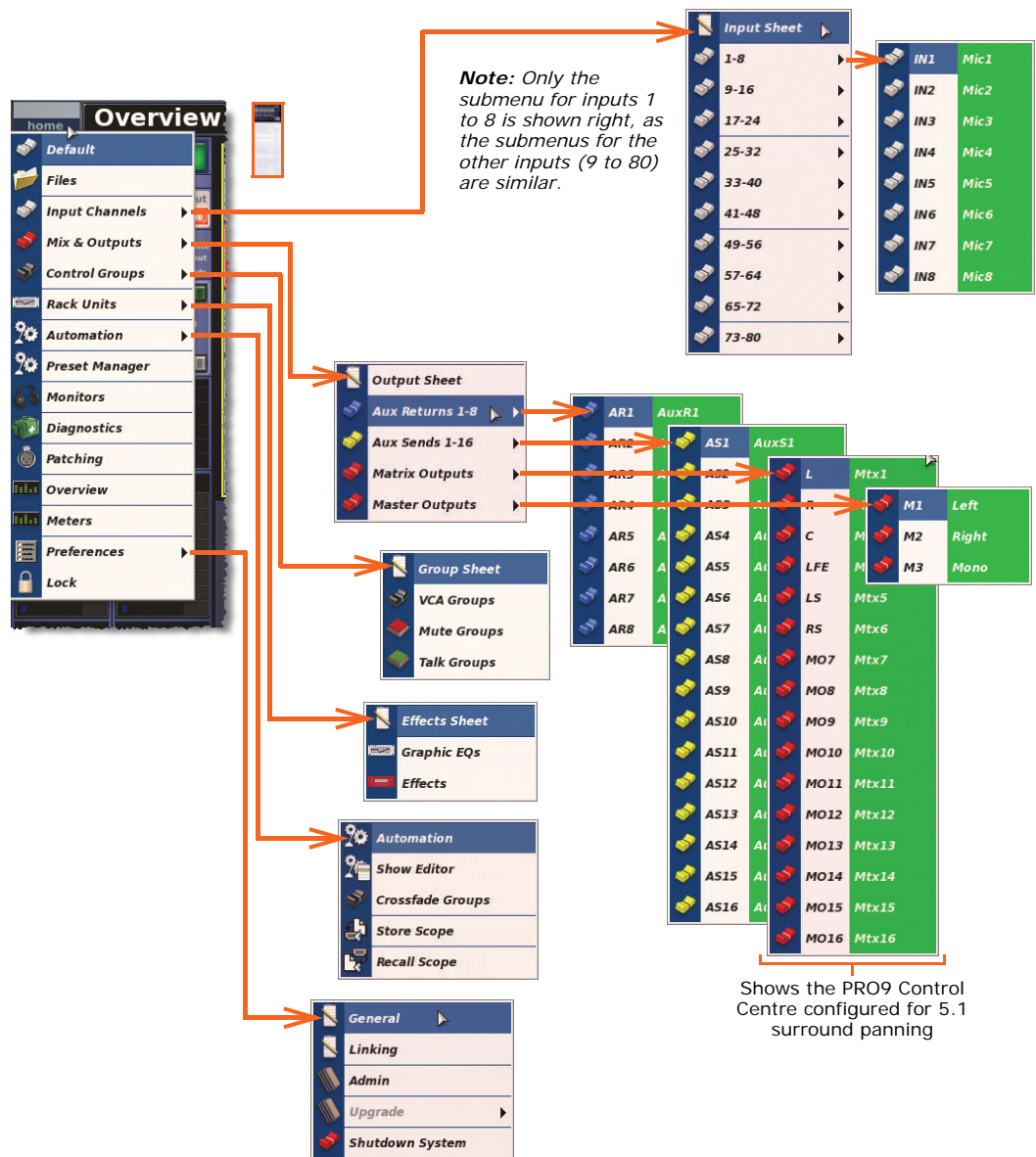

Figure 42: PRO9 GUI menu flowchart

GUI menu options

The GUI menu, which can be opened from either GUI screen, presents you with a main list of options that open specific screens or submenus, as shown in the following table.

<i>Option</i>	<i>Description/function</i>
Default	Opens the default display applicable to the GUI screen you are operating (see “GUI” on page 30). If the GUI screen has been mapped to the other bay, its default screen will match that bay (see “Mapping a GUI screen to another bay” on page 398).
Files	Opens the Files screen (see “Managing show files on the Files screen” on page 210).
Input Channels	Input channel option, which opens a submenu with the following options: <ul style="list-style-type: none"> • Input Sheet — lets you configure all of the input channels (see “Configuring the channels, groups and internal units” on page 251). • 1-8 through to nn-nn (depending on PRO Series Control Centre) — click one to open its associated bank of inputs, or its submenu. Each submenu contains the eight inputs belonging to its bank; click on one to select its channel.
Mix & Outputs	Output channel option, which opens a submenu with the following options: <ul style="list-style-type: none"> • Output Sheet — lets you configure the output channels (see “Configuring the channels, groups and internal units” on page 251). • Output channel options — click one to open the associated bank of outputs (returns, auxes, matrices or masters), or open the submenu. Each submenu contains the outputs belonging to its bank; click on one to select its channel.
Control Groups	Control groups (VCA/POP, auto-mute and talk) option, which opens a submenu with the following options: <ul style="list-style-type: none"> • Group Sheet — lets you configure each group (see “Configuring the channels, groups and internal units” on page 251). • VCA Groups — click to open the VCA Groups screen, or open the submenu, which contains an option each for the 12 VCA groups and eight POP groups; click on one to select its group. See “VCA and POP groups” on page 177. • Mute Groups — click to open the Mute Groups screen (see “Auto-mute (mute) groups” on page 180). • Talk Groups — click to open the Talk Groups screen (see “Talk groups” on page 181).
Rack Units	Internal units option, which opens a submenu with the following options: <ul style="list-style-type: none"> • Effects Sheet — lets you configure each ‘virtual’ GEO and internal effect rack unit (see “Configuring the channels, groups and internal units” on page 251). • Graphic EQs — opens the Graphic EQs screen (see “About the Graphic EQs screen” on page 158). • Effects — opens the Effects screen (see “Overview of the internal effects” on page 163).

<i>Option</i>	<i>Description/function</i>
Automation	Automation option, which opens a submenu with the following options: <ul style="list-style-type: none"> • Automation — opens the Automation screen (see Chapter 20 "Scenes And Shows (Automation)" on page 197). • Show Editor — opens the Show Editor screen (see "Show editor" on page 117). • Store Scope — opens the Store Scope screen (see "About the Recall Scope screen" on page 213). • Recall Scope — opens the Recall Scope screen (see "About the Recall Scope screen" on page 213).
Preset Manager	Opens the Preset Manager screen (see Chapter 24 "User Libraries (Presets)" on page 235).
Monitors	Opens the Monitors screen (see Chapter 14 "Monitors And Communications" on page 143).
Diagnostics	Opens the Diagnostics screen (see "Diagnostics" on page 393).
Patching	Opens the Patching screen (see Chapter 8 "Patching" on page 71).
Preferences	Preferences option, which opens a submenu with the following options: <ul style="list-style-type: none"> • General — opens the Preferences screen (see Chapter 27 "Changing The User Settings" on page 247). • Linking — opens the Stereo Linking Default Settings window (see "To set the global default stereo linking options" on page 128). • Admin — opens the administrator's window. This is a supervisor-only function, which is accessed by typing in a password. • Upgrade — opens a list of TAR files from which to choose when updating the PRO Series Live Audio System's software (see "Updating your system" on page 410). • Shutdown System — opens the shutdown message window, which initiates an expedient shutdown of the PRO Series Control Centre (see "To switch off the control centre" on page 43).
Lock	Locks the GUI (see "Security (locking mode)" on page 124).

You can access some of the screens directly from the primary navigation zone (see "To open a GUI menu screen using a screen access button" on page 57).

Appendices

Appendix A: Application Notes

This chapter provides more in-depth information on certain areas and functions of the PRO Series.

Spatial imaging system (SIS™)

Although conventional consoles can be used for three-channel mixing, the methods for doing so are complicated and unorthodox. This forces the engineer to work in unaccustomed ways, limiting creative flexibility, and making use by visiting operators impractical. The spatial imaging system (SIS™) has been developed to overcome this.

The following are just some of the advantages provided by SIS™:

- Backing vocalists can be panned slightly towards the centre cluster to improve intelligibility, while keeping the featured vocal 'front and centre'.
- Musical instruments can be placed in a conventional mix and then easily switched to the centre for solos.
- In theatrical productions, SIS™ lets you pan an actor's voice across three channels, following their on stage movements. In stereo-only productions the centre output can be used to provide a mono-to-mix-base feed activating a single 'left + right to centre' switch.
- The ability of SIS™ to feed centre-panned signals equally to both left and right outputs, as well as the centre, is particularly useful for distributing the load of high energy, centre-panned sounds across all FOH loudspeaker arrays.

PRO Series compressor modes (dynamic)

This section aims to provide an understanding of the compressor modes contained within the PRO Series Control Centre.

Description

The PRO Series compressors have five primary operating modes (only four on the inputs). These change the signature (or shape) of the attack and release envelope curves, interactions and timings. Before dealing with this in detail, some of the generic terms are defined and explained:

Threshold

The threshold adjusts the operating point of the compressor. Signals that go over this point, or *over-threshold*, will be affected by compressor action. Signals that stay below threshold will not trigger any compression, although they may still be affected by compression releases from previous over-threshold signals.

Ratio

The compression ratio control provides control of the amount of compression that is applied to over-threshold signals. This is expressed as a ratio of signal level changes from input to output. For example, when the compressor is set to 2:1, every 2dB input level change will only generate a 1dB output level change (assuming the signal levels are over-threshold).

Attack

The attack control adjusts the time taken for the compressor to respond to an over-threshold signal. The shape of the attack can be selected from one of the five mode combinations mentioned above, making the compressor easily adaptable for a wide number of creative and corrective applications.

Release

The release control adjusts the time the compressor takes to recover after the programme material falls back below threshold. Both attack and release also respond to changes in programme level that remain over-threshold. For example, a signal that reduces in level, but remains above threshold will still trigger a release, but in this case it will only be a partial release. This is because the compressor will still be required to generate gain reduction, but now, as appropriate for the new lower signal level.

Knee

Most compression sounds more natural in soft knee mode. Soft knee compression blurs the distinction between over-threshold and under-threshold signals, such that signals that are a long way below threshold remain unaffected by compression, and signals that near the threshold get compressed, but at greatly reduced ratios. When signals are just over-threshold the compressor ratios are still somewhat reduced; it is only when signals go well over threshold that the full ratio compression is applied. When using a harder knee setting the compressors operate in a more clinical way with a more defined transition between under-threshold and over-threshold; this is better suited to limiting style compression.

Gain

The gain control provides adjustment of the *make up* gain so that the level of the outgoing compressed signal can be matched to the incoming uncompressed signal. It can also be used to drive the *clipper* hard (see "Soft clip level" on page 342) to produce more pronounced effects.

Side chain filter

A band pass filter is provided that acts on the side chain signals. This can be used to make the compression frequency selective. The controls for this are frequency, adjustable from 50Hz to 15kHz, and bandwidth selectable as wide medium or narrow. Additionally, there is a listen function that places the filtered side chain onto the solo bus and a side chain filter in to activate or eliminate the filter action.

Soft clip level

When compression is used creatively with slower attack times, it is possible to generate very large peak signals that can eat up headroom. When *soft clip* is activated the compressor output (post-make up gain) is fed through a final fast acting soft clipper circuit. This adds progressive gain reduction to any signals that exceed a threshold set by the *clip level* control. When set sparingly, this can recover 3dB to 6dB of headroom without introducing any undesirable audio artefacts. (In the past, limiters have been employed for this function but their time constants are invariably intrusive on the programme.) The high-speed nature of the soft clipping introduces no time related artefacts. This is because it only acts during the transient peaks, when it produces predominantly third harmonic distortion, which is very musical in nature.

Compressor envelope modes

The five envelope *modes*, or *signatures*, are the key to the sonic character of the PRO Series compressors, and they allow adjustment far beyond the normal capabilities of simple attack and release settings. They largely fall into two application types:

- 1 Compressors that are good at capturing and controlling dynamic transients: corrective mode and vintage mode.
- 2 Compressors that emphasise dynamic transients and provide creative control of levels within a mix: adaptive, creative and shimmer modes.

The Vintage and Adaptive compressors tend to morph a little between these two categories depending on threshold control settings. This makes them easy to use intuitively with minimal fine-tuning of the envelope control settings.

Further refinement and enhancement of the envelope modes is provided by the three-position **KNEE** switch. It is best to understand the operation of this function in more depth before looking at the detail of the compressor signature switching.

Knee

The soft knee curves behave in a traditional way to blend the compression ratio around the threshold setting (as described above), but more importantly they also have a significant effect on the attack envelope shapes. The soft knee typically slows down attack speed on signals in the knee area, which is desirable for natural sounding compression because it compliments the reduced ratio effect of the soft knee. This produces very gentle compression in the knee region.

The **KNEE** switch has three settings: hard (4dB); medium (12dB); and soft (40dB). In hard setting the compressor still retains some soft knee characteristics. This is because the implementation of an extremely hard knee produces undesirable sounding distortion on low frequency programme material.

Corrective mode (exponential peak - fast)

This is a peak sensing compressor (like many older designs) with exponential attack and release. It produces aggressive compression that gives good fast control/limiting of dynamic material. It can be used to add colour to low frequency signals, thus making it ideal for controlling extremely dynamic instruments like the bass guitar. The compressor tends to sound best with fast attack time settings that capture transients and with release adjusted to taste to either emphasise or minimise distortion and pumping effects.

Adaptive mode (exponential RMS - accurate)

This is a root-mean-square (RMS) sensing compressor with exponential attack and release. The RMS averaging process interacts with the attack and release to produce a very adaptive envelope character. This allows faster attacks on large (over-threshold) signal changes and produces slower attacks on small signal changes, regardless of attack time setting. The attack control is still active, allowing some user intervention although the adaptive nature makes envelope control setting fairly non-critical. The compressor is therefore very fast and simple to set up on most programme material. It is also sonically accurate and works well for both compression and limiting of vocals and many other sources. The most natural sounding compression is normally achieved with *soft knee* settings.

Creative mode (linear peak - slow)

This is a peak sensing compressor with linear (dB rate) attack and second order release. The compressor is very transparent, providing some dynamic control but without unduly affecting the intentional dynamic content of the source material. The linear attack provides a constant rate of attack, such that large changes in programme signal level take longer to become compressed than smaller changes. Adding *soft knee*

noticeably delays these attacks, which can be particularly useful on drums where compression can be applied to emphasise transients giving more punch while retaining a good deal of artistic dynamic from the drummer.

The compressor normally sounds best with slower attack time settings, when it can be used on difficult instruments, such as the acoustic guitar, with relatively fast release to keep equal perceived loudness within a mix without producing excessive flutter or distortion.

Vintage mode (adaptive peak - bright)

This is a peak sensing compressor with a partially adaptive nature. It produces extremely subtle attack and release curves during the onset of compression that are largely independent of the envelope control settings. However, as it is driven harder, that is, signals are further over-threshold, the attack and release times become more aggressive and gradually return to manual control so that the operator can optimise the capture (or otherwise) of larger transients etc. The peak sensing algorithm intentionally increases harmonic overtones during compression, which adds a *valve-like* brightness and sparkle to the programme, producing extremely natural and lively sounding compression of acoustic instruments.

Shimmer mode (overshoot peak - slow) - output only

This is a peak sensing compressor with an exponential release and unusual second order attack character that tends to *overshoot*.

If used sparingly, the compressor sounds very soft and natural, and can provide additional control of material that already has a fairly low dynamic content. It can sound very transparent on vocals where it retains a good degree of life in the performance.

If used at higher ratios with slow attack and fast release times, the compressor can produce a very soft, bouncy sound character.

PRO Series input channel EQ modes

This section aims to provide an understanding of the input channel EQ modes contained within the PRO Series Control Centre.

Basic specification

The PRO Series input EQ comprises four bands: treble; hi mid; lo mid; and bass. The default operation for all four sections is full parametric sweep (peak), with the following controls:

- **Gain:** continuous adjustment of boost and cut from + 16dB to - 16dB with a 0dB centre detent.
- **Width:** continuous adjustment of bandwidth from 0.1 to 3.0 octaves (this only operates in bell mode for Bass and Treble).
- **Treble:** continuous adjustment of the frequency range that the treble equaliser acts on from 1kHz to 25kHz.
- **Hi mid and lo mid:** hi mid frequency control gives continuous adjustment of the frequency range that the hi mid equaliser acts on from 320Hz to 8kHz. Lo mid frequency control gives continuous adjustment of the frequency range that the lo mid equaliser acts on from 80Hz to 2kHz.
- **Bass:** continuous adjustment of the frequency range that the bass equaliser acts on from 16Hz to 400Hz.

The treble EQ band can be switched from bell to any of three other shelving modes:

- Soft
- Classic
- Bright

The bass EQ band can be switched from bell to any of three other shelving modes:

- Warm
- Classic
- Deep

Description of the input channel EQ modes

The difference between the shelf filters is subtle and, if you do not have time to experiment, it is probably best to use classic because this is the best all round filter. However, when you do have time to experiment you may find the other types each have their uses. The minimum harmonic types, and in particular the bass, can sound very natural, even with very aggressive EQ, but the psycho-acoustic principles that they operate on do not always work so well on multiple source or pre-mixed material.

Soft treble

The soft treble response provides a very gentle gradient between EQ'd and non-EQ'd frequency areas. This produces the absolute minimum of phase shift, but does not provide much differentiation, thus frequencies outside the area of interest are often unintentionally EQ'd. This is best used to provide gentle shaping of pre-mixed material.

Classic treble

The classic treble response provides a much steeper gradient between EQ'd and non-EQ'd frequency areas, as made famous by previous Midas consoles like the XL4. This provides better differentiation and minimal phase shift, but there is some undershoot error, that is, when boosting the treble, the mids are slightly cut and vice

versa. This is the best all round EQ and especially effective when microphones are covering multiple sources.

Bright treble

The bright treble response provides a slightly steeper gradient than the classic and it is uniquely shaped to provide minimum harmonic disruption to the EQ'd material. As for the classic EQ, this provides better differentiation and minimal phase shift, but now there is no undershoot error corrupting the mids. This is best used on single source material and especially good for acoustic performances.

Warm bass

The warm bass response provides a very gentle gradient between EQ'd and non-EQ'd frequency areas. This produces the absolute minimum of phase shift, but does not provide much differentiation, thus frequencies outside the area of interest are often unintentionally EQ'd. This is best used to provide gentle shaping of pre mixed material.

Classic bass

The classic bass response provides a much steeper gradient between EQ'd and non-EQ'd frequency areas and is modelled on the XL4. This provides better differentiation and minimal phase shift, but there is some undershoot error, that is, when boosting the bass, the mids are slightly cut and vice versa. This is often desirable on bass EQ and it is the best all round, general purpose EQ curvature.

Deep bass

The deep bass response provides a slightly steeper gradient than the classic and it is uniquely shaped to provide minimum harmonic disruption to the EQ'd material. As for the classic EQ, this provides better differentiation and minimal phase shift, but there is no undershoot error. Powerful boost/cut can be used that still sounds very natural and does not corrupt the mids. This is best used on single source material.

PRO Series output channel EQ modes

This section aims to provide an understanding of the output channel EQ modes contained within the PRO Series Control Centre.

Basic specification

The PRO Series output EQ comprises six bands strategically positioned at certain frequencies ranging from the low end (bass) to the high (treble) of the frequency band. The default operation for all six sections is full parametric sweep (peak), with the following controls:

- **Gain:** continuous adjustment of boost and cut from + 16dB to -16dB, with a 0dB centre detent.
- **Width:** continuous adjustment of bandwidth from 0.1 to 3.0 octaves.
- **Frequency:** continuous adjustment of the frequency range that the band EQ acts on from 16Hz to 25kHz.

Band 1 can be switched from bell to any of three shelving modes:

- Warm
- High pass filter 6dB
- High pass filter 12dB

Band 2 can be switched from bell to high pass filter 24dB shelving mode.

Band 6 can be switched from bell to any of three shelving modes:

- Soft
- Lo pass filter 6dB
- Lo pass filter 12dB

Description of the output channel EQ modes

Soft (treble)

The soft treble response provides a very gentle gradient between EQ'd and non-EQ'd frequency areas. This produces the absolute minimum of phase shift, but does not provide much differentiation, thus frequencies outside the area of interest are often unintentionally EQ'd. This is best used to provide gentle shaping of pre-mixed material.

Warm (bass)

The warm bass response provides a very gentle gradient between EQ'd and non-EQ'd frequency areas. This produces the absolute minimum of phase shift, but does not provide much differentiation, thus frequencies outside the area of interest are often unintentionally EQ'd. This is best used to provide gentle shaping of pre-mixed material.

High pass filter (HPF)

The HPF attenuates (not boosts) all frequencies below a certain level (cut-off frequency) while allowing all those above it to pass through. The harshness or smoothness with which the sound is removed beyond this point is determined by the dB/octave, with 6dB being the most common. The HPF is generally used to take rumble or hum out of any sound source, but may also produce a sound effect by manipulation of the controls.

The high pass filters of the PRO Series have gain roll off before the corner frequency, which is variable.

Lo pass filter (LPF)

The LPF attenuates (not boosts) all frequencies above a certain level (cut-off frequency), while allowing all those below it to pass through. The harshness or smoothness with which the sound is removed beyond this point is determined by the dB/octave, with 6dB being the most common. The LPF is generally used to reduce noise in quiet passages or to take the *fizz* off any source with excessively high frequencies, but may also produce a sound effect by manipulation of the controls.

The low pass filters of the PRO Series have gain roll off after the corner frequency, which is variable.

Appendix B: Technical Specification

This appendix provides the full technical specification for the PRO Series Live Audio Systems, which include the DL251 Audio System I/O, DL351 Modular I/O, DL371 Audio System Engine and DL451 Modular I/O, and the optional DL431 Mic Splitter.

Due to a policy of continual improvement, Midas reserves the right to alter the function or specification at any time without notice.

PRO Series general statistics

<i>Item</i>	<i>Item</i>	PRO3	PRO6	PRO9
Configurable XLR connections	1 x Control Surface I/O box houses 24 x I/O slots in 3 x 8 wide blocks of: 8 x (XLR) mic/line inputs or 8 x (XLR) line outputs or 8 x (Jack) line in and 8 x line out or 4 x (stereo) AES3 in and 4 x (stereo) AES3 out	✓	✓	✓
	1 x 7U rack DL351 Modular I/O box houses 64 x I/O slots in 8 x 8 wide blocks of: 8 x (XLR) mic/line inputs or 8 x (XLR) line outputs or 8 x (Jack) line in and 8 x line out or 4 x (stereo) AES3 in and 4 x (stereo) AES3 out	✗	✓	✓
	1 x 3U rack configurable DL451 Modular I/O box houses 24 x I/O slots in 3 x 8 wide blocks of: 8 x (XLR) mic/line inputs or 8 x (XLR) line outputs or 8 x (Jack) line in and 8 x line out or 4 x (stereo) AES3 in and 4 x (stereo) AES3 out	✗	✗	✓
Fixed XLR connections	1 x 5U rack fixed configuration DL251 Audio System I/O box houses 48 (XLR) mic/line inputs	✓	✗	✗

<i>Item</i>	<i>Item</i>	PRO3	PRO6	PRO9
Typical configuration (assuming all analogue I/O)	I/O Box mic/line inputs (XLR)	48	56	80
	Surface mic/line auxiliary inputs	8	8	8
	Total mic input count	56	64	88
	8 x (XLR) I/O box master/matrix outputs			
	8 x (Jack) Surface aux/group outputs			
	8 x (Jack) Surface assignable inputs			
	8 x (Jack) Surface assignable outputs			
	1 x (XLR) Surface stereo master output			
	2 x (XLR) Surface stereo monitor outputs			
	System expansion (optional rack boxes)	Multiple 3U rack configurable I/O boxes can be connected that house 24 x I/O slots in 8 x 8 wide blocks of: 8 x (XLR) mic/line inputs or 8 x (XLR) line outputs or 8 x (Jack) line in and 8 x line out 4 x (stereo) AES3 in and 4 x (stereo) AES3 out	✓	✓
Multiple 5U rack fixed configuration I/O boxes that house: 48 x (XLR) mic/line inputs 16 x (XLR) outputs		✓	✓	✓
Multiple 6U rack Splitters house 96 x Splitter mic/line inputs 2 x 96 Splitter outputs 1 x 96 transformer isolated Splitter outputs		✓	✓	✓
Input audio processing	Dual slope high and low pass filters	48	56	80
	4-band parametric EQs (includes 8 returns) with 3 shelf modes	56	64	88
	4-mode creative input compressors	48	56	80
	Input gates	48	56	80
Mix/output audio processing	Output 5-band parametric EQ with shelf and multiple high and low pass modes	27	35	35
	5-mode creative output dynamics	27	35	35
	Assignable Klark Teknik output GEQs	8	8	8
Assignable audio processing	8 x assignable stereo effects (each can be reconfigured to generate 4 additional GEQs, making a total of 36 available on the control centre)	✓	✓	✓
Mixing control assistance	8 x auto-mutes 6 x surface population groups 10 x VCA faders 10 x VCA associated population groups 1000-scene snapshot automation	✓	✓	✓
Resilience	N+1 and fault tolerant modular system with dual redundant system interconnections	✓	✓	✓

PRO Series general specifications

Sampling frequency	96kHz
Latency delay	<2ms input to master (no compensation)
Dynamic range	110dB, 22Hz to 22kHz (no pre-emphasis)
Maximum voltage gain	80dB inputs to subgroups and masters 86dB inputs to aux and matrix
Crosstalk at 1kHz	-100dB physically adjacent input channels
Crosstalk at 10kHz	-100dB physically adjacent input channels
Fader/pan cut off at 1kHz	-100dB
Fader/pan cut off at 10kHz	-100dB
Display screens	2 x 15" daylight-viewable colour screens
LCD switch	33 x RGB colour
Motorised faders	29 x touch-sensitive
Fader resolution	1024 steps
Encoders	102 x touch-sensitive
Encoder resolution	512 steps
Dimensions	PRO Series Control Centre: 1300 x 1000 x 400 mm DL251 I/O Box: 5U x 410 mm deep DL351 I/O Box: 7U x 410 mm deep DL371 DSP: 7U x 410 mm deep DL451 I/O Box: 3U x 410 mm deep
Net weight (standard install)	<p>PRO3: Control centre: 120 kg 1 x DL251: 10 kg 1 x DL371: 30 kg Total: 160 kg</p> <p>PRO6: Control centre: 120 kg 1 x DL351: 50 kg 1 x DL371: 30 kg Total: 200 kg</p> <p>PRO9: Control centre: 120 kg 1 x DL351: 50 kg 1 x DL371: 30 kg 1 x DL451: 13 kg Total: 213 kg</p>
Power requirements	100V to 240V, 50 to 60Hz
Operating temperature range	+5°C to +40°C
Storage temperature range	-20°C to +60°C

PRO Series audio performance specifications

Frequency response

<i>Input</i>	<i>Output</i>	<i>Gain</i>	<i>20Hz</i>	<i>20kHz</i>
DL251 I/O Box	DL251 I/O Box	0dB	0dB to -1.0dB	0dB to -1.0dB
DL251 I/O Box	DL251 I/O Box	40dB	0dB to -1.0dB	0dB to -1.0dB
DL351 I/O Box	DL351 I/O Box	0dB	0dB to -1.0dB	0dB to -1.0dB
DL351 I/O Box	DL351 I/O Box	40dB	0dB to -1.0dB	0dB to -1.0dB
Surface I/O	Surface I/O	0dB	0dB to -1.0dB	0dB to -1.0dB
Surface I/O	Surface I/O	40dB	0dB to -1.0dB	0dB to -1.0dB
DL451 I/O Box	DL451 I/O Box	0dB	0dB to -1.0dB	0dB to -1.0dB
DL451 I/O Box	DL451 I/O Box	40dB	0dB to -1.0dB	0dB to -1.0dB
DL431 Splitter	DL351 I/O Box	0dB	0dB to -1.0dB	0dB to -1.0dB
DL431 Splitter	DL351 I/O Box	40dB	0dB to -1.0dB	0dB to -1.0dB
DL431 Splitter	DL431 A Out	0dB	0dB to -0.5dB	0dB to -0.5dB
DL431 Splitter	DL431 A Out	40dB	0dB to -0.5dB	0dB to -0.5dB
DL431 Splitter	DL431 B Out	0dB	0dB to -0.5dB	0dB to -0.5dB
DL431 Splitter	DL431 B Out	40dB	0dB to -0.5dB	0dB to -0.5dB
DL431 Splitter	DL431 C Out	-6dB	0dB to -1.0dB	0dB to -1.0dB

Gain error at 1kHz

<i>Input</i>	<i>Output</i>	<i>Gain</i>	<i>Maximum</i>	<i>Minimum</i>
DL251 I/O Box	DL251 I/O Box	0dB	+1.0dB	-1.0dB
DL251 I/O Box	DL251 I/O Box	40dB	+1.0dB	-1.0dB
DL351 I/O Box	DL351 I/O Box	0dB	+1.0dB	-1.0dB
DL351 I/O Box	DL351 I/O Box	40dB	+1.0dB	-1.0dB
Surface I/O	Surface I/O	0dB	+1.0dB	-1.0dB
Surface I/O	Surface I/O	40dB	+1.0dB	-1.0dB
DL451 I/O Box	DL451 I/O Box	0dB	+1.0dB	-1.0dB
DL451 I/O Box	DL451 I/O Box	40dB	+1.0dB	-1.0dB
DL431 Splitter	DL451 I/O Box	0dB	+1.0dB	-1.0dB
DL431 Splitter	DL451 I/O Box	40dB	+1.0dB	-1.0dB
DL431 Splitter	DL431 A Out	0dB	+0.5dB	-0.5dB
DL431 Splitter	DL431 A Out	40dB	+0.5dB	-0.5dB
DL431 Splitter	DL431 B Out	0dB	+0.5dB	-0.5dB
DL431 Splitter	DL431 B Out	40dB	+0.5dB	-0.5dB
DL431 Splitter	DL431 C Out	-6dB	+1.0dB	-1.0dB

Input CMRR

<i>Input</i>	<i>Output</i>	<i>Gain</i>	<i>100Hz</i>	<i>1kHz</i>
DL251 I/O Box	DL251 I/O Box	0dB	80dB	80dB
DL251 I/O Box	DL251 I/O Box	40dB	90dB	90dB
DL351 I/O Box	DL351 I/O Box	0dB	80dB	80dB
DL351 I/O Box	DL351 I/O Box	40dB	90dB	90dB
Surface I/O	Surface I/O	0dB	80dB	80dB
Surface I/O	Surface I/O	40dB	90dB	90dB
DL451 I/O Box	DL451 I/O Box	0dB	80dB	80dB
DL451 I/O Box	DL451 I/O Box	40dB	90dB	90dB
DL431 Splitter	DL451 I/O Box	0dB	80dB	80dB
DL431 Splitter	DL451 I/O Box	40dB	90dB	90dB
DL431 Splitter	DL431 A Out	0dB	80dB	80dB
DL431 Splitter	DL431 A Out	40dB	90dB	90dB
DL431 Splitter	DL431 B Out	0dB	80dB	80dB
DL431 Splitter	DL431 B Out	40dB	90dB	90dB
DL431 Splitter	DL431 C Out	-6dB	110dB	90dB

Distortion at 0dBu

<i>Input</i>	<i>Output</i>	<i>Gain</i>	<i>1kHz</i>	<i>10kHz</i>
DL251 I/O Box	DL251 I/O Box	0dB	0.01%	0.01%
DL251 I/O Box	DL251 I/O Box	40dB	0.03%	0.03%
DL351 I/O Box	DL351 I/O Box	0dB	0.01%	0.01%
DL351 I/O Box	DL351 I/O Box	40dB	0.03%	0.03%
Surface I/O	Surface I/O	0dB	0.01%	0.01%
Surface I/O	Surface I/O	40dB	0.03%	0.03%
DL451 I/O Box	DL451 I/O Box	0dB	0.01%	0.01%
DL451 I/O Box	DL451 I/O Box	40dB	0.03%	0.03%
DL431 Splitter	DL431 A Out	0dB	0.01%	0.01%
DL431 Splitter	DL431 A Out	40dB	0.03%	0.03%
DL431 Splitter	DL431 B Out	0dB	0.01%	0.01%
DL431 Splitter	DL431 B Out	40dB	0.03%	0.03%
DL431 Splitter	DL431 C Out	-6dB	0.01%	0.01%
DL431 Splitter	DL451 I/O Box	0dB	0.01%	0.01%
DL431 Splitter	DL451 I/O Box	40dB	0.03%	0.03%

Distortion at +20dBu

<i>Input</i>	<i>Output</i>	<i>Gain</i>	<i>1kHz</i>	<i>10kHz</i>
DL251 I/O Box	DL251 I/O Box	0dB	0.03%	0.03%
DL251 I/O Box	DL251 I/O Box	40dB	0.03%	0.03%
DL351 I/O Box	DL351 I/O Box	0dB	0.03%	0.03%
DL351 I/O Box	DL351 I/O Box	40dB	0.03%	0.03%
Surface I/O	Surface I/O	0dB	0.03%	0.03%
Surface I/O	Surface I/O	40dB	0.03%	0.03%
DL451 I/O Box	DL451 I/O Box	0dB	0.03%	0.03%
DL451 I/O Box	DL451 I/O Box	40dB	0.03%	0.03%
DL431 Splitter	DL431 A Out	0dB	0.03%	0.03%
DL431 Splitter	DL431 A Out	40dB	0.03%	0.03%
DL431 Splitter	DL431 B Out	0dB	0.03%	0.03%
DL431 Splitter	DL431 B Out	40dB	0.03%	0.03%
DL431 Splitter	DL431 C Out	-6dB	0.03%	0.03%
DL431 Splitter	DL451 I/O Box	0dB	0.03%	0.03%
DL431 Splitter	DL451 I/O Box	40dB	0.03%	0.03%

Signal path noise 22Hz to 22kHz unweighted

Inputs 150R terminated.

<i>Input</i>	<i>Output</i>	<i>Gain</i>	<i>Output Noise</i>	<i>EIN</i>
DL251 I/O Box	DL251 I/O Box	0dB	-86dBu	-86dBu
DL251 I/O Box	DL251 I/O Box	40dB	-86dBu	-126dBu
DL351 I/O Box	DL351 I/O Box	0dB	-89dBu	-89dBu
DL351 I/O Box	DL351 I/O Box	40dB	-87dBu	-127dBu
Surface I/O	Surface I/O	0dB	-89dBu	-89dBu
Surface I/O	Surface I/O	40dB	-87dBu	-127dBu
DL451 I/O Box	DL451 I/O Box	0dB	-89dBu	-89dBu
DL451 I/O Box	DL451 I/O Box	40dB	-87dBu	-127dBu
DL431 Splitter	DL431 A Out	0dB	-98dBu	-98dBu
DL431 Splitter	DL431 A Out	40dB	-88dBu	-128dBu
DL431 Splitter	DL431 B Out	0dB	-98dBu	-98dBu
DL431 Splitter	DL431 B Out	40dB	-88dBu	-128dBu
DL431 Splitter	DL431 C Out	-6dB	-123dBu	-117dBu
DL431 Splitter	DL451 I/O Box	0dB	-89dBu	-89dBu
DL431 Splitter	DL451 I/O Box	40dB	-87dBu	-127dBu

Dynamic range 22Hz to 22kHz unweighted

<i>Input</i>	<i>Output</i>	<i>Gain</i>	<i>Maximum Output</i>	<i>Dynamic Range</i>
DL251 I/O Box	DL251 I/O Box	0dB	+21dBu	107dB
DL251 I/O Box	DL251 I/O Box	40dB	+21dBu	107dB
DL351 I/O Box	DL351 I/O Box	0dB	+21dBu	110dB
DL351 I/O Box	DL351 I/O Box	40dB	+21dBu	108dB
Surface I/O	Surface I/O	0dB	+21dBu	110dB
Surface I/O	Surface I/O	40dB	+21dBu	108dB
DL451 I/O Box	DL451 I/O Box	0dB	+21dBu	110dB
DL451 I/O Box	DL451 I/O Box	40dB	+21dBu	108dB
DL431 Splitter	DL431 A Out	0dB	+26dBu	124dB
DL431 Splitter	DL431 A Out	40dB	+26dBu	114dB
DL431 Splitter	DL431 B Out	0dB	+26dBu	124dB
DL431 Splitter	DL431 B Out	40dB	+26dBu	114dB
DL431 Splitter	DL431 C Out	-6dB	+21dBu	144dB
DL431 Splitter	DL451 I/O Box	0dB	+21dBu	110dB
DL431 Splitter	DL451 I/O Box	40dB	+21dBu	108dB

PRO Series system inputs and outputs

DL251 I/O Box

Analogue inputs

Connector	3-pin XLR balanced
A/D converter	24-bit, 96k and 128 times over sampling

Analogue outputs

Connector	3-pin XLR balanced
D/A converter	24-bit, 96k and 128 times over sampling

MIDI

MIDI connector	In, out and through on 5-pin DIN
GPIO IN connector	25-pin D-type (opto isolated)
GPIO OUT connector	25-pin D-type (opto isolated)

Digital system inputs and outputs

System connector	2 x AES50 (24 channels of bi-directional digital audio) on EtherCon® XLR
N+1 connector	1 x AES50 (24 channels of bi-directional digital audio) on EtherCon® XLR providing redundant back up

DL351 I/O Box

Analogue inputs

Connector	3-pin XLR balanced
A/D converter	24-bit, 96k and 128 times over sampling

Analogue outputs

Connector	3-pin XLR balanced
D/A converter	24-bit, 96k and 128 times over sampling

Digital inputs

Connector	AES3 (two channels of digital audio) on 3-pin XLR
Sample rates	Accepts any frequency between 32k to 96k
Bypass	Sample rate converter can be bypassed

Digital outputs

Connector	AES3 (two channels of digital audio) on 3-pin XLR
Sample rates	48k, 96k or auto tracking to inputs
Bypass	Sample rate converter can be bypassed
Word length	16-, 20- or 24-bit

Analogue Jack inputs and outputs

Connector	16 x 1/4" TRS (8 x inputs (returns) and 8 x outputs (sends))
Miscellaneous	Balanced, normalising and low latency

MIDI and GPIO

MIDI connector	In, out and through on 5-pin DIN
GPIO IN connector	25-pin D-type (opto isolated)
GPIO OUT connector	25-pin D-type (opto isolated)

Digital system inputs and outputs

System connector	3 x AES50 (24 channels of bi-directional digital audio) on EtherCon® XLR
N+ 1 connector	1 x AES50 (24 channels of bi-directional digital audio) on EtherCon® XLR providing redundant back up

DL451 I/O Box**Analogue inputs**

Connector	3-pin XLR balanced
A/D converter	24-bit, 96k and 128 times over sampling

Analogue outputs

Connector	3-pin XLR balanced
D/A converter	24-bit, 96k and 128 times over sampling

Digital inputs

Connector	AES3 (two channels of digital audio) on 3-pin XLR
Sample rates	Accepts any frequency between 32k to 96k
Bypass	Sample rate converter can be bypassed

Digital outputs

Connector	AES3 (two channels of digital audio) on 3-pin XLR
Sample rates	48k, 96k or auto tracking to inputs
Bypass	Sample rate converter can be bypassed
Word length	16-, 20- or 24-bit

MIDI and GPIO

MIDI connector	In, out and through on 5-pin DIN
GPIO IN connector	25-pin D-type (opto isolated)
GPIO OUT connector	25-pin D-type (opto isolated)

Digital system inputs and outputs

System connector	AES50 (24 channels of bi-directional digital audio) on Ethercon XLR
Duplicate connector	AES50 (24 channels of bi-directional digital audio) on Ethercon XLR providing dual redundant back up of channels

DL431 Splitter (option)**Analogue inputs**

Connector	3-pin XLR balanced
Phantom power	48-volt with local switch and remote control from PRO Series Control Centre
Gain control A	-2.5dB to +45dB analogue gain in 2.5dB steps with local and remote control; plus a further ± 20 dB of high resolution interpolated DSP trim
Gain control B	Independent second channel identical to Gain control A (above)
Filter A	30Hz high pass with local defeat switch and remote control from PRO Series Control Centre
Filter B	Independent second channel identical to Filter A (above)
Meter (quantity 24)	7-segment -18dBu to +24dBu
Meter A/B	Meters can be switched to monitor A or B pre-amplifiers
A/D converter A	24-bit, 96k and 128 times over sampling
A/D converter B	Independent second channel identical to A/D converter A (above)

Analogue outputs

Connector A	3-pin XLR balanced
Connector B	Independent second channel identical to Connector A (above)
Connector C	Independent third channel on front mounted 3-pin XLR, balanced and transformer isolated (with fixed gain of -6dB)
Headphone connector	¼" Jack
Audio monitor	3-pin XLR balanced

Digital (system) outputs

System connector A	AES50 (24 channels of digital audio) on Ethercon XLR
System connector B	Independent second channel identical to System connector A (above)
Duplicate connector A	AES50 (24 channels of digital audio) on Ethercon XLR providing dual redundant back up of A channels
Duplicate connector B	AES50 (24 channels of digital audio) on Ethercon XLR providing dual redundant back up of B channels

DL371 DSP/Router*System inputs and outputs*

System connector	3 x AES50 (24 channels of bi-directional digital audio) on EtherCon® XLR
N+1 connector	1 x AES50 (24 channels of bi-directional digital audio) on EtherCon® XLR providing dual redundant back up
System expansion connector	4 x AES50 (24 channels of bi-directional digital audio) on EtherCon® XLR
Snake connector (copper)	HyperMac (192 channels of bi-directional digital audio) on EtherCon® XLR
Duplicate snake connector (copper)	HyperMac (192 channels of bi-directional digital audio) on EtherCon® XLR
Snake connector (fibre)	HyperMac (192 channels of bi-directional digital audio) on OpticalCon® XLR
Duplicate snake connector (fibre)	HyperMac (192 channels of bi-directional digital audio) on OpticalCon® XLR

Miscellaneous inputs and outputs

<i>Word clock IN connector</i>	BNC
<i>Word clock OUT connector</i>	BNC
<i>AES3 Sync IN connector</i>	3-pin XLR
<i>AES3 Sync OUT connector</i>	3-pin XLR
<i>External connector</i>	EtherCon® XLR

PRO Series Control Surface*Analogue audio system inputs*

<i>Connector</i>	3-pin XLR balanced
<i>A/D converter</i>	24-bit, 96k and 128 times over sampling
<i>Connector</i>	¼" Jack balanced
<i>A/D converter</i>	24-bit, 96k and 128 times over sampling
<i>Talkback connector</i>	3-pin XLR balanced line
<i>Talk connector</i>	3-pin XLR balanced mic with 48V phantom voltage
<i>Meters (quantity 16)</i>	20-segment -36dBu to +21dBu

Analogue audio system outputs

<i>Connector</i>	3-pin XLR balanced
<i>D/A converter</i>	24-bit, 96k and 128 times over sampling
<i>Connector</i>	¼" Jack balanced
<i>D/A converter</i>	24-bit, 96k and 128 times over sampling
<i>Monitor connector</i>	3-pin XLR balanced line
<i>Talk connector</i>	3-pin XLR balanced line
<i>Headphone connector</i>	¼" Jack (stereo)
<i>Meters (quantity 9)</i>	20-segment -36dBu to +21dBu

Digital audio system inputs and outputs

Input connector	AES3 (two channels of digital audio) on 3-pin XLR
Sample rates	Accepts any frequency 32k to 96k
Bypass	Sample rate converter can be bypassed
Output connector	AES3 (two channels of digital audio) on 3-pin XLR
Sample rate	48k, 96k or auto tracking to inputs
Bypass	Sample converter can be bypassed
Word length	16-, 20- or 24-bit
System expansion connector	3 x AES50 (24 channels of bi-directional digital audio) on Ethercon XLR
Snake connector (copper)	HyperMac (192 channels of bi-directional digital audio) on Ethercon XLR
Duplicate snake connector (copper)	HyperMac (192 channels of bi-directional digital audio) on Ethercon XLR
Snake connector (fibre)	HyperMac (192 channels of bi-directional digital audio) on Opticon XLR
Duplicate snake connector (copper)	HyperMac (192 channels of bi-directional digital audio) on Opticon XLR

Control data system inputs and outputs

System connector	Ethercon XLR
Duplicate connector	Ethercon XLR providing dual redundant back up

Miscellaneous inputs and outputs

Word clock IN connector	BNC
Word clock OUT connector	BNC
AES3 sync IN connector	3-pin XLR
AES3 sync OUT connector	3-pin XLR
External (Ethernet) connector	Ethercon XLR
Monitor input connector	3-row, 15-pin D-type, analogue VGA
KVM input connection	Screen 3-row, 15-pin D-type (analogue VGA) and USB keyboard/mouse
USB host connection Line I/O + Mic Splitter	USB 2.0 full speed (12.0Mbs) 500mA maximum load
USB slave connection Line I/O + Mic Splitter	USB 2.0 full speed (12.0Mbs)
USB host connection Surface	USB 2.0 full speed (12.0Mbs) 1A maximum load

PRO Series input and output characteristics

Analogue input characteristics

<i>Input Type</i>	<i>Load Z</i>	<i>Gain</i>	<i>Max. Level</i>	<i>Connector</i>
DL251 I/O Box	10K	-25dB to +60dB	+26dBu	XLR
DL351 I/O Box	10K	-25dB to +60dB	+26dBu	XLR
Surface I/O	10K	-25dB to +60dB	+26dBu	XLR
DL451 I/O Box	10K	-25dB to +60dB	+26dBu	XLR
DL431 Splitter	10K	-22.5dB to +65dB	+24dBu	XLR
Talk mic	600R	+15dB to +60dB	+6dBu	XLR
Monitor	10K	0dB	+24dBu	XLR

Analogue output characteristics

<i>Output Type</i>	<i>Source Z</i>	<i>Gain</i>	<i>Max. Level</i>	<i>Connector</i>
DL251 I/O Box	50R	0dB	+21dBu	XLR
DL351 I/O Box	50R	0dB	+21dBu	XLR
Surface I/O	50R	0dB	+21dBu	XLR
DL451 I/O Box	50R	0dB	+21dBu	XLR
DL431 Splitter Main	150R	0dB	+24dBu	XLR
DL431 Splitter Isolated	75R	-6dB	+18dBu	XLR
Talk mic	50R	0dB	+24dBu	XLR
Monitor	50R	0dB	+24dBu	XLR
Headphones	10R	+10dB	750mW	¼" Jack

Digital I/O characteristics

<i>Type</i>	<i>Chan.</i>	<i>Data Length</i>	<i>I/O</i>	<i>Description Notes</i>	<i>Conn.</i>
AES3	2	24-bit	Input	Conforms to AES3 - 2003	XLR
AES3	2	24-bit	Output	Conforms to AES3 - 2003	XLR
AES50	24	24-bit	Bi-directional	Conforms to AES50 -2006	Ethercon XLR
HyperMac	192	24-bit	Bi-directional	Cat 5e, Gigabit Ethernet physical layer	Ethercon XLR
HyperMac	192	24-bit	Bi-directional	850 nm, laser module 1.25Gb/s 1000 base-SX physical layer on 50/125 multimode fibre	Opticon XLR

Miscellaneous digital characteristics

<i>Type</i>	<i>I/O</i>	<i>Description Notes</i>	<i>Connector</i>
Word clock	IN	Accepts TTL level, 96kHz square wave; impedance 75 ohms	BNC
Word clock	OUT	Provides a TTL level, 96kHz square wave	BNC
AES sync	IN	Accepts a 96kHz digital audio signal conforming to AES3 - 2003	XLR
AES sync	OUT	Provides a 96kHz grade II reference signal conforming to AES3 - 2003	XLR
External (Ethernet)	-	Cat 5e, Auto MDIX, 10Mb/s Fast Ethernet physical layer	Ethercon XLR

PRO Series main processing functions

Main input channel functions

<i>Input channel hi pass</i>	10Hz to 400Hz swept in digital domain Slope selectable 12dB/Oct or 24dB/Oct
<i>Input channel lo pass</i>	2kHz to 20kHz swept in digital domain Slope selectable 6dB/Oct or 12dB/Oct
<i>Input channel treble</i>	Parametric operation Frequency 1kHz to 25kHz swept Gain +16dB to -16dB BW 0.1 Oct to 3 Oct Shelf operation Frequency 1kHz to 25kHz swept Gain +16dB to -16dB Soft, classic or bright (minimum harmonic disruption) curves
<i>Input channel hi mid</i>	Parametric operation Frequency 320Hz to 8kHz swept Gain +16dB to -16dB BW 0.1 Oct to 3 Oct
<i>Input channel lo mid</i>	Parametric operation Frequency 80Hz to 2kHz swept Gain +16dB to -16dB BW 0.1 Oct to 3 Oct
<i>Input channel bass</i>	Parametric operation Frequency 16Hz to 400Hz swept Gain +16dB to -16dB BW 0.1 Oct to 3 Oct Shelf operation Frequency 16Hz to 400Hz swept Gain +16dB to -16dB Warm, classic or deep (minimum harmonic disruption) curves
<i>Input channel compressor</i>	Peak, linear, RMS and vintage modes (Corrective, Adaptive, Creative and Vintage) Threshold -50dBu to +20dBu Attack 200µs to 20ms Release 50ms to 3s Ratio 25:1 to 1:1 Knee 4dB, 12dB or 40dB Gain 0dB to +24dB Side chain source selectable + filter Frequency 50Hz to 15kHz swept Bandwidth 1/3, 1 or 2 Oct

<i>Input channel gate</i>	Peak mode Threshold -50dBu to +20dBu Attack 20 μ s to 20ms Hold 5ms to 2s Release 5ms to 2s Range ∞ to 0dB Side chain source selectable + filter Frequency 50Hz to 15kHz swept Bandwidth 1/3, 1 or 2 Oct
----------------------------------	---

Auxiliary input channel functions

<i>Aux channel treble</i>	Parametric operation Frequency 1kHz to 25kHz swept Gain +16dB to -16dB BW 0.1 Oct to 3 Oct Shelf operation Frequency 1kHz to 25kHz swept Gain +16dB to -16dB Soft, classic or bright (minimum harmonic disruption) curves
<i>Aux channel hi mid</i>	Parametric operation Frequency 320Hz to 8kHz swept Gain +16dB to -16dB BW 0.1 Oct to 3 Oct
<i>Aux channel lo mid</i>	Parametric operation Frequency 80Hz to 2kHz swept Gain +16dB to -16dB BW 0.1 Oct to 3 Oct
<i>Aux channel bass</i>	Parametric operation Frequency 16Hz to 400Hz swept Gain +16dB to -16dB BW 0.1 Oct to 3 Oct Shelf operation Frequency 16Hz to 400Hz swept Gain +16dB to -16dB Warm, classic or deep (minimum harmonic disruption) curves

Output channel functions

<i>Output channel band 6</i>	Parametric operation Frequency 16Hz to 25kHz swept Gain +16dB to -16dB BW 0.1 Oct to 3 Oct Lo pass operation Frequency 16Hz to 25kHz swept Slope 6dB/Oct or 12dB/Oct Shelf operation Frequency 16Hz to 25kHz swept Gain +16dB to -16dB Mode soft curve
<i>Output channel bands 3, 4 and 5</i>	Parametric operation Frequency 16Hz to 25kHz swept Gain +16dB to -16dB BW 0.1 Oct to 3 Oct
<i>Output channel band 2</i>	Parametric operation Frequency 16Hz to 25kHz swept Gain +16dB to -16dB BW 0.1 Oct to 3 Oct Hi pass operation Frequency 16Hz to 25kHz swept Slope 24dB/Oct
<i>Output channel band 1</i>	Parametric operation Frequency 16Hz to 25kHz swept Gain +16dB to -16dB BW 0.1 Oct to 3 Oct Hi pass operation Frequency 16Hz to 25kHz swept Slope 6dB/Oct or 12dB/Oct Shelf operation Frequency 16Hz to 25kHz swept Gain +16dB to -16dB Mode soft curve

<i>Output channel GEQ</i>	16 available in place of PEQ (above) 31 bands, 1/3 Oct, proportional Q Lo pass frequency 2kHz to 20kHz swept Slope 6dB/Oct or 12dB/Oct Hi pass frequency 20Hz to 500Hz swept Slope 6dB/Oct or 12dB/Oct
<i>Output channel dynamic</i>	Peak, linear, RMS, vintage and shimmer modes (Corrective, Adaptive, Creative, Vintage and Shimmer) Threshold -50dBu to +25dBu Attack 200µs to 20ms Release 50ms to 3s Ratio 25:1 to 1:1 Knee 4dB, 12dB or 40dB Gain 0dB to +24dB Side chain source selectable + filter Frequency 50Hz to 15kHz swept Bandwidth 1/3, 1 or 2 Oct

Effects channel functions

<i>Stereo effects channel</i>	8 available configurable as Stereo or mono in, stereo out Modulated delay effects Complex delay, reverbs Advanced dynamics RTA and advanced measurements
<i>Effects channel GEQ</i>	32 available in place of effects (above) 31 bands, 1/3 Oct, proportional Q Lo pass frequency 2kHz to 20kHz swept Slope 6dB/Oct or 12dB/Oct Hi pass frequency 20Hz to 500Hz swept Slope 6dB/Oct or 12dB/Oct

PRO Series status functions

Meters

Control Centre meters	9 x output 20-LED -36dBu to +21dBu 16 x input 20-LED -36dBu to +21dBu 32 x gain reduction 7-LED
Screen metering	105 x 20-segment signal level meters 112 x 7-segment gain reduction (or 144 including aux and matrix gain reduction meters for the compressors)

Screens

Quantity	2 x full-colour daylight-viewable screens
Size	15" (diagonal)
Resolution	1024 x 768 pixels
External screen	2 x output connectors for remote screens

Screen functions

Source	Each screen can be switched to source either the local control centre or an external input
KVM	Screen 2 can be switched to operate up to 3 external computers utilising the control centre trackball and keyboard
Internal GUI	Advanced interpolated graphics support all control centre functions

LCD switches

Quantity	33 x RGB colour display switches
Size	18 mm x 12 mm display area
Resolution	36 x 24 pixels

Appendix C: Klark Teknik DN370 GEQ

This appendix contains information on the Klark Teknik DN370 GEQ unit that is pertinent to the PRO Series.

Notes

When reading the Klark Teknik DN370 GEQ in relation to the PRO Series, take the following into consideration:

- **Constant-Q versus Symmetrical-Q:** In the manual, Constant-Q is referred to as Symmetrical-Q. There is a note in the manual to say that Symmetrical-Q is inaccurately referred to as Constant-Q.
- For “DN370” in manual, read “GEQ”.
- SPL = sound pressure level.
- Although the manual refers to a physical unit, this can still apply to the virtual GEQ equivalent of the PRO Series. For example, the pushbuttons in the units on the Graphic EQs screen have the same functions as the ones on the physical unit, and the on-screen faders represent the unit’s long-throw ones etc.
- The GEQ of the PRO Series has 31 bands, as compared to 30 on the DN370. The extra band is at a frequency centre of 20Hz, and is adjusted by the leftmost fader.

Using the GEQ

This 31-band, third octave graphic equaliser provides a high degree of accuracy and control. Graphic equalisers may be used for corrective or creative purposes, depending upon whether they are used live (MON or FOH) or in the studio (broadcast or recording).

Studio and creative use

In the control room, a graphic equaliser may be used to remove problem frequencies and improve deficiencies in room acoustics. This is commonly achieved with the use of a real time analyser (RTA). As the frequency centres of the PRO Series Control Centre conform to ISO standards, corrections can be made by sight directly from the RTA to the graphic.

There are many creative and corrective uses for the GEQ. For example, by using the 31 equaliser bands and the high and low pass filters you can achieve the effect of someone speaking on the telephone. When used in conjunction with a compressor, you can create a de-esser. The GEQ can also be used for tonal correction of instruments or vocals.

Live use (MON)

A monitor engineer may use an RTA to detect these peaks but, more often than not, monitor engineers have a developed sense of hearing that enables them to remove these frequencies by ear. The GEQ’s 31 bands allow a majority of feedback to be removed from the monitors. High and low pass filters are provided that can be used to remove high frequency feedback and bass rumble or over-excursion of bass drivers (the GEQ on the PRO Series has no variable notch filters). It may also be undesirable to have large amounts of bass in the on-stage monitors. In vocal monitors, bass does not

assist projection of vocals and can make the stage sound unbearable, hence, the bass element can be rolled off at the desired frequency. The fundamentals of vocals are transmitted in a narrow audible range and will appear unaffected.

Bypassing the EQ

It may be desirable to hear the effect of the graphic equaliser settings, for example, during a sound check. To do this, press the EQ in/out switch so that it is set to out (the red out LED is illuminated); this bypasses the EQ (and gain) settings of the GEO, allowing the user to hear the original audio without adjusting any fader or control.

Placing the fader of any band at the extreme upwards position will apply 12dB gain to frequencies in that band. Placing the fader of any band at the extreme downwards position will apply 12dB of attenuation, depending upon the RANGE switch's setting, to the frequencies in that band.

Audio signal path

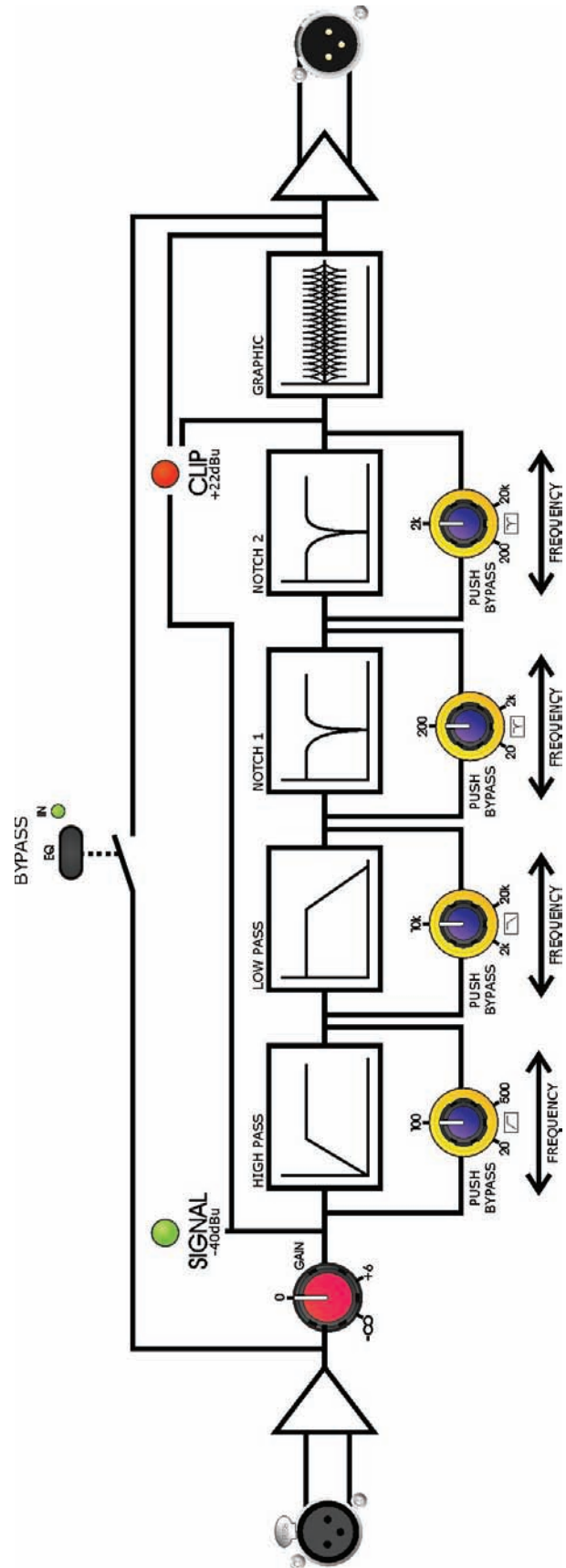

Appendix D: Klark Teknik DN780 Reverb

This appendix contains parameter application notes for the DN780 reverb internal effect on the PRO Series. This is followed by information on the special effects program and technical specifications of the PRO Series Control Centre's DN780.

Parameter application notes

This section provides application notes on the parameters of the DN780 Reverb effect.

Pre-delay

0 to 990 milliseconds (ms) of pre-delay is available allowing a very wide range of control. Delays of less than 30ms closely integrate the direct and reverberant sounds; often a desirable feature on percussive sounds. Delays of 50ms or more cause the direct and reverberant sounds to separate and convey a feeling of depth and distance to the simulated environment. Delays above 2300ms are used for creating special effects.

Pattern

The pattern control alters the 'density' of the early reflections. It is adjustable from 0 to 9 as shown on display f1, with 0 giving a low density or 'grainy' character to the early reflections and 9 producing a high density effect.

Level

The level control functions convincingly as a 'depth' control, altering the apparent distance between the sound source and the listener. It is adjustable from 0 to 9 as shown on display f2, with 0 being relatively distant and 9 bringing the sound source closer.

Decay

The reverberation decay time is adjustable from 0.1 to 18 seconds, depending on room size, changing the reverberant field from a virtually dead sound to a totally surreal effect. Short decay times, under one second, are essential for authentic small room simulation and also extremely useful for ambience applications where classic reverberation is not wanted. Reverb times of 1 to 4 seconds cover the majority of normal applications where classic reverberation is required. Longer decay times are available for special effect applications.

LF key

LF is adjustable to ± 7 , depending on room size and decay time, as shown on display f3. An increase in LF decay time is generally desirable on simulations of large halls, since low frequency sounds suffer less than higher frequencies from absorption in air. Very small spaces usually need the 'thin' sound created by reducing LF decay.

HF key

HF is adjustable to ± 7 , as shown on display f4. The HF decay control sets the absorption characteristic of the simulated space. In reality, large environments feature considerably reduced high frequency decay times due to air absorption. A smaller room will feature greater HF decay time if the walls are tiled and the room is empty than if the room contains soft furnishings and curtains. The wide range of control provided will allow a suitable setting to be chosen to enhance realism in most applications.

Room size

Room size is adjustable from 8 to 90 linear metres, representing a wide range of volumes. Since the acoustic character of a given environment depends not only on the reverberation time and construction of the room, but also to a great extent on its volume. The room size control is, in fact, essential if authentic simulation of a range of different sized environments is required. Small room sizes give a confined, 'box-like' sound. Medium room sizes suggest a room or small hall, whereas large room sizes suggest a large hall or cathedral. Again, there is no substitute for experimentation.

About the special effects programs

This section gives details of the effects programs available on the DN780 Reverb effect.

Direct signal

Effects such as 'ADT' and 'Echo' rely on a suitable level of direct (dry) signal being added on the mixing console. Since this is largely a question of taste, no precise instructions are included here. It is recommended that, as a general principle, direct signal is initially set at a normal operation level without any effect present. The effect is then increased in level as required.

"Delay" effect

PRE DELAY control knob adjusts the delay time within the range 0 to 2.0 seconds.

REV button mutes the effect.

Preset parameters: On selecting this effect program, delay is set to 200ms.

Stereo mix: The signals at left and right outputs are both delayed by the same amount as set using the PRE DELAY control, that is, they are essentially monophonic.

Application Notes:

- Use this program to accurately balance echo return levels on the mixing console.
- In normal use, only one output should be used.

"ADT" effect

PRE DELAY control knob adjusts the delay time before the second voice is heard. Delay is adjustable within the range 0 to 127ms.

PATTERN control knob selects the number and spacing of the second voices. Selection is from Pattern 1 (two voices) to Pattern 5 (eight voices).

REV button mutes the effect.

Preset parameters: On selecting this effect program, delay is set to 40ms and pattern is Pattern 5 (a wide multi-voiced effect).

Stereo mix: Left and right output signals use different delay taps to achieve a stereo effect. Using only one output halves the number of 'voices', that is, Pattern 1 (one voice) to Pattern 5 (four voices).

Application Notes:

- Try delays from 25 to 50ms. Short delays reduce the effect, long delays produce echo.
- Direct signal must be added at a suitable level on the mixing console. Try 50/50 direct/effect mix on Pattern 1, must less direct on Pattern 5.
- For conventional ADT, try 'Delay' of 40ms, Pattern 1, and use one output only, panned, say, fully right. Pan direct signal fully left and use a 50/50 direct/effect mix.

"Multi-Tap Echo" effect

PRE DELAY control knob adjusts the time delay interval between the direct signal and the first repeat. Delay is adjustable from 0 to 990ms.

PATTERN control knob selects the number and spacing of the repeats. Pattern 1 (two repeats) to Pattern 9 (eight repeats).

DECAY control knob sets the feedback (regeneration) level for repeat echoes.

HF control knob allows the high frequency filtering to be applied to the regenerated signal.

REV button mutes the effect.

Preset parameters: On selecting this effect program: delay is set to 196ms; pattern is Pattern 4; decay is 73; and HF is 0. These settings give an effect similar to a typical multi-head tape echo, but with full stereo image.

Stereo mix: Different delay taps are used for left and right outputs to achieve a stereo effect. Using only one output halves the number of taps, that is, Pattern 1 (one tap), Pattern 9 (four taps).

Application Notes:

- Set delay time as required, generally fairly short for multi-echoes (higher pattern numbers), and longer for repeat echo. 'Fine tune' delay setting to set exact musical timing for single tap repeat echoes.
- Direct signal must be added at a suitable level on the mixing console.
- For single tap repeat echo, start with Pattern 1, with 'Delay', 'HF' and 'Decay' all set at maximum. Reduce parameters as required. Use one output only.

"Sound-On-Sound" effect

PRE DELAY control knob sets the 'loop length' and hence the timing of the effect between 0 and 2.0 seconds.

LEVEL control knob provides 10 level increments of signal input to the 'digital loop'. Return level to '0' after use to avoid noise build-up.

DECAY control knob sets the 'erasure' of the loop from '0' (100% erasure) to '99' (zero erasure).

REV button clears memory of unwanted effect.

Preset parameters: On selecting this effect program: pre-delay is set to 2.0s; level is 0; and decay is 99. These settings represent maximum loop length with zero erasure. Please note that no sound will be heard until 'level' is increased.

Stereo mix: Outputs left and right are essentially identical. However, to avoid the possibility of slight phase cancellations, it is recommended that only one output is used on this program.

Application Notes:

- Since the 'level' inside the signal processor increases as fresh input is added, input level must be lower than that recommended for normal use; try -15dB on the

headroom indicator. Digital overload will be indicated by the red LED illuminating on the headroom indicator.

- Correct pre-delay ('loop length') should be set before creating the effect as attempts to alter this later will usually destroy part of the recorded sound.
- Remember to return level to '0' immediately after used to avoid noise build-up.

"Infinite Room" effect

LEVEL control knob provides 10 level increments of signal input to the 'infinite room'. Return level to '0' after use to avoid noise build-up.

REV button clears memory of unwanted effect.

Preset parameters: On selecting this effect program, level is 0. Please note that no sound will be heard until 'level' is increased.

Stereo mix: Infinite room is a spacious, full stereo effect.

Application Notes:

- Since the 'level' inside the signal processor increases as fresh input is added, input level must be less than that recommended for normal use; try -15dB on the headroom indicator. Digital overload will be indicated by the red LED illuminating on the headroom indicator.
- Remember to return level to '0' immediately after used to avoid noise build-up.

"Alive", "Non-Linear" and "Reverse" effects

PRE DELAY control knob sets the delay between the direct signal and the onset of the effect. Maximum pre-delay is 990ms.

PATTERN control knob changes the density of the reflections, with 0 giving a low density or 'grainy' character and 9 producing a high density effect.

DECAY control knob sets the length of the effect, from '1' (short) to '12' (long). The display simply shows these increment numbers and is not calibrated in seconds.

LF control knob adjusts the low frequency content of the effect.

HF control knob adjusts the high frequency content of the effect.

REV button clears memory of unwanted effect.

Preset parameters:

- "Alive" - on selecting this effect program: pre-delay is 0s; pattern is 9; decay is 8; LF is +1; and HF is +3.
- "Non-Linear" - on selecting this effect program: pre-delay is 0s; pattern is 4; decay is 5; LF is 0; and HF is 0.
- "Reverse" - on selecting this effect program: pre-delay is 0s; pattern is 4; decay is 12; LF is 0; and HF is +2.

Stereo mix: All these effects are in full stereo and are completely mono-compatible.

Application Notes:

- These three effects will find instant application in any recording studio engaged in contemporary music production, as they allow pronounced acoustical enhancement without the 'muddying' effect of longer, conventional decay envelopes. This makes possible a bright and 'punchy' mix. These effects work well on most instruments, but try "Non-Linear" for explosive snare sounds and "Reverse" on vocals.
- The "Alive" program produces a more natural, live ambience, which is less coloured than the other two effects and has wide-ranging applications.

Technical specifications

Audio

Frequency response	+1, -2dB (20Hz to 12kHz)
Dynamic range	85dB typical

Digital

Arithmetic processor	32-bit
Reverberation	Hall, Plate, Chamber and Room, with five variations of each
Effects	Alive, Non-Linear, Reverse, Delay, ADT, Multitap Echo, Sound-On-Sound and Infinite Room

Parameters

Pre-delay	0 to 990ms
Pattern (density)	Adjustable 0 to 9 increments (Grainy to Dense)
Level (depth)	Adjustable 0 to 9 increments (Distant to Close)
Decay time	0.1 to 18 seconds
Room size	8 to 90 metres linear dimension
LF decay	Adjustable ± 7 increments ref. 1kHz decay time
HF decay	Adjustable ± 7 increments ref. 1kHz decay time

Since the above reverberation parameters are optimised to ensure authentic acoustical simulation, they are by necessity program-dependent.

Controls

Input mute	Removes audio feed from reverberation section.
Reverb mute	Clears unwanted reverberant signal.
Input level control	From 6dB gain to infinite attenuation.
Headroom indicator	10-point LED display, 0dB to -27dB.
Display	Simultaneous display of all parameter information. Parameter selection and store functions are verified by individual LEDs.

Appendix E: I/O Modules

There are three module slots (to the right of the rear panel of the PRO6) into which any combination of the following modules can be fitted:

- DL441 analogue input module; see “DL441 analogue input module” on page 380.
- DL442 analogue output module; see “DL442 analogue output module” on page 381.
- DL443 analogue insert input/output module; see “DL443 analogue Jack I/O module” on page 382.
- DL444 analogue D-type input/output module; see “DL444 analogue D-type I/O module” on page 384.
- DL452 digital in/out (AES/EBU) module; see “DL452 digital I/O module” on page 389.

Details of how to replace a module can be found in Appendix F “Replacing A Module”.

DL441 analogue input module

The DL441 analogue input module provides eight balanced line (or mic) inputs. Its rear panel houses eight input XLRs, each with a **check** and a **48V** LED.

The line inputs may be used as simple unity gain inputs to the PRO6, such as insert returns. However, there is also provision for gain adjustment in 5dB steps from -5dB to +40dB. This allows very high signal levels to enter the system and means that the same hardware can be used for mic inputs, if required by the system.

When used for microphones the input can also provide 48-volt phantom power.

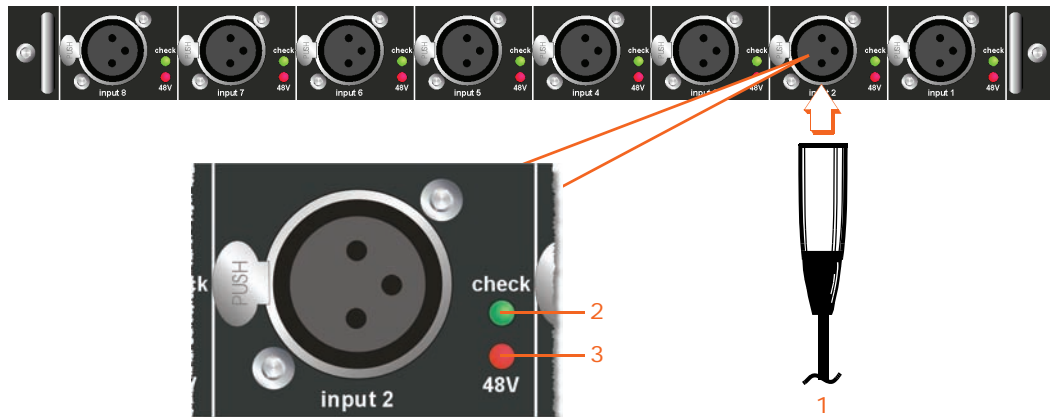

DL441 module connectors

Item	Description
1	Eight XLR analogue mic/line inputs.
2	Green check LED illuminates to show when a channel is selected on a console. These are controlled by the console and are used as a visual aid to locate specific connectors.
3	Red 48V LED illuminates to show that 48V phantom voltage is on.

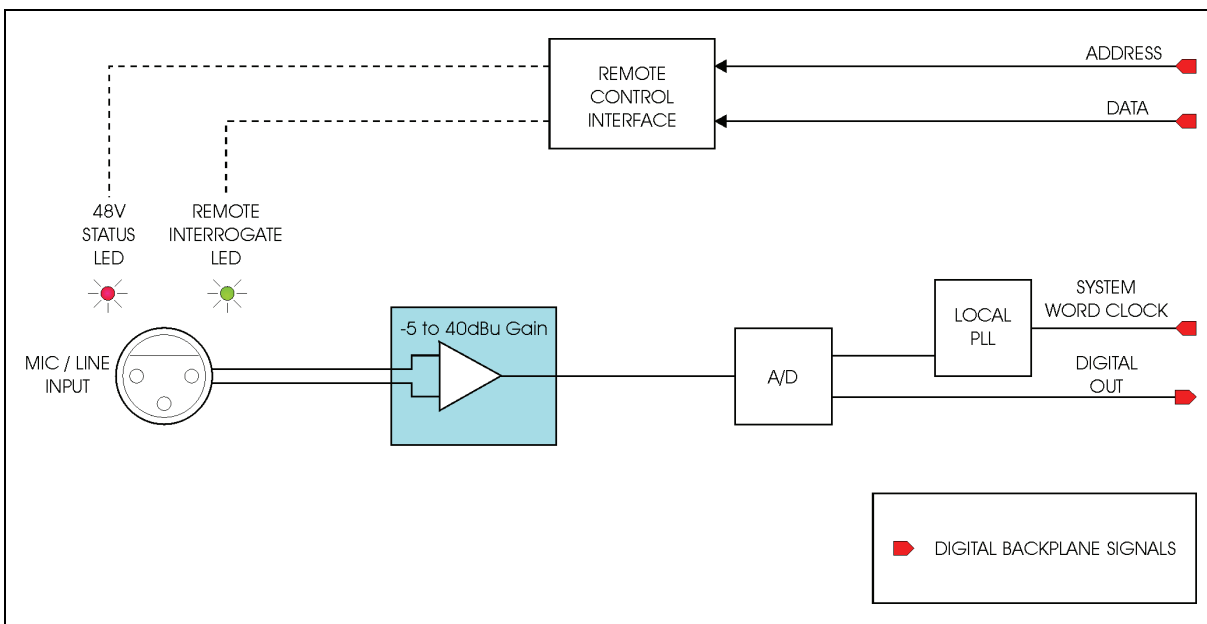

Functional block diagram of the DL441 module

DL442 analogue output module

The DL442 analogue output module provides eight balanced line outputs. Its rear panel houses eight output XLRs, each with a **check** and a **mute** LED.

The line outputs have no analogue level adjustment.

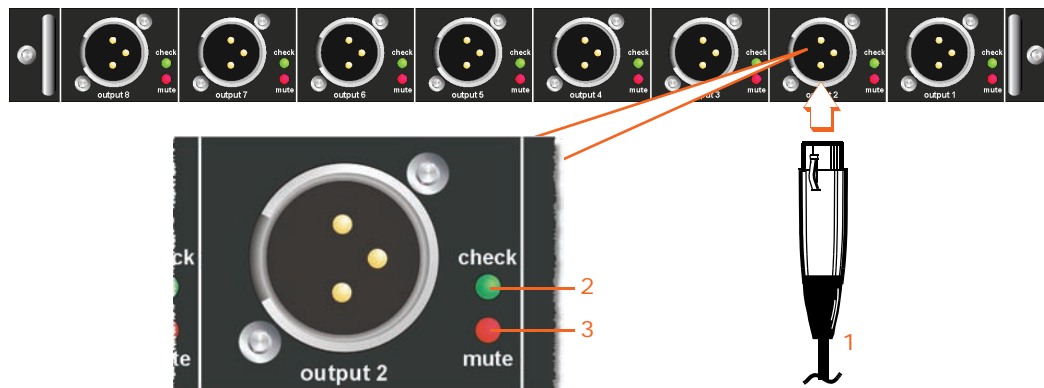

DL442 module connectors

Item	Description
1	Eight XLR analogue outputs.
2	Green check LED illuminates to indicate when a channel is selected on the console. These are controlled by the console and are used as a visual aid to locate specific connectors.
3	Red mute LED illuminates to show when the channel is muted on the console.

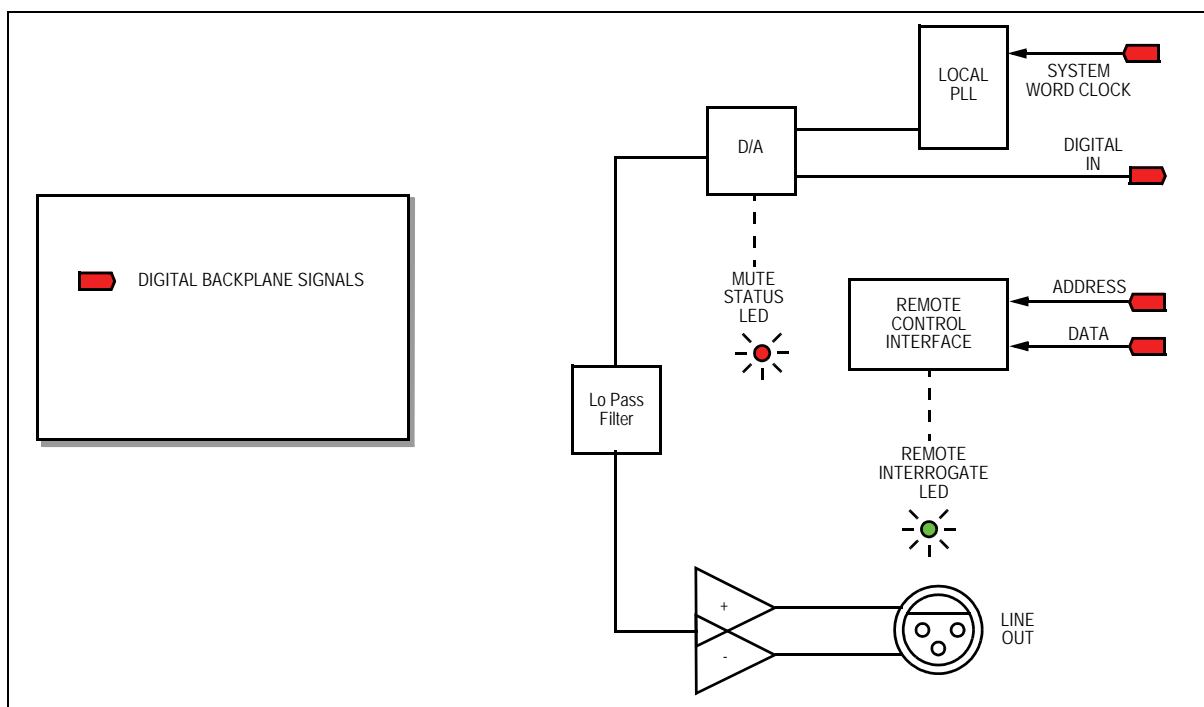

Functional block diagram of the DL442 module showing 1 of 8 channel paths

DL443 analogue Jack I/O module

The DL443 Jack I/O module provides a reliable, robust, high quality option where maximum connectivity is required at reduced cost. It has normalising and low latency, and is of robust construction.

The DL443 Jack I/O module has a total of 16 ¼" Jack sockets providing eight outputs (sends) and eight inputs (returns). Each output has a red **mute** status LED.

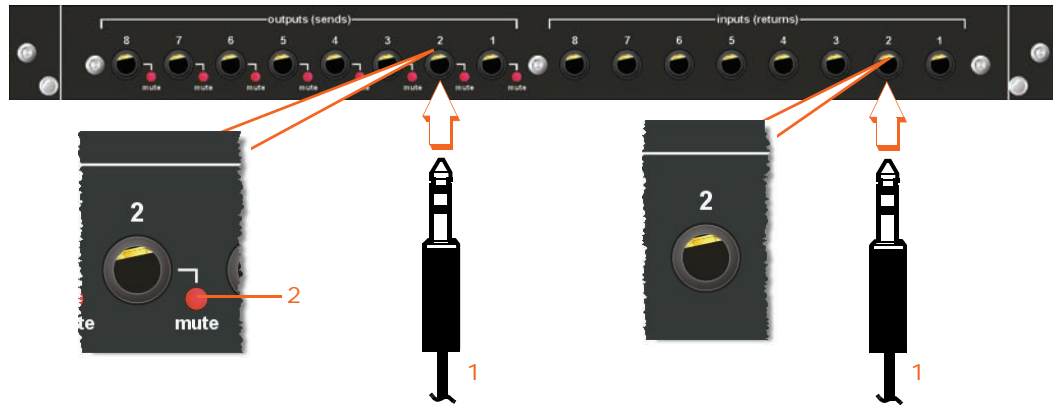

DL443 module connectors

Item	Description
1	Eight jack sockets per inputs (returns) section and eight jack sockets per outputs (sends) section.
2	Red mute LED on each outputs (sends) jack socket illuminates to show when a channel is muted on the console.

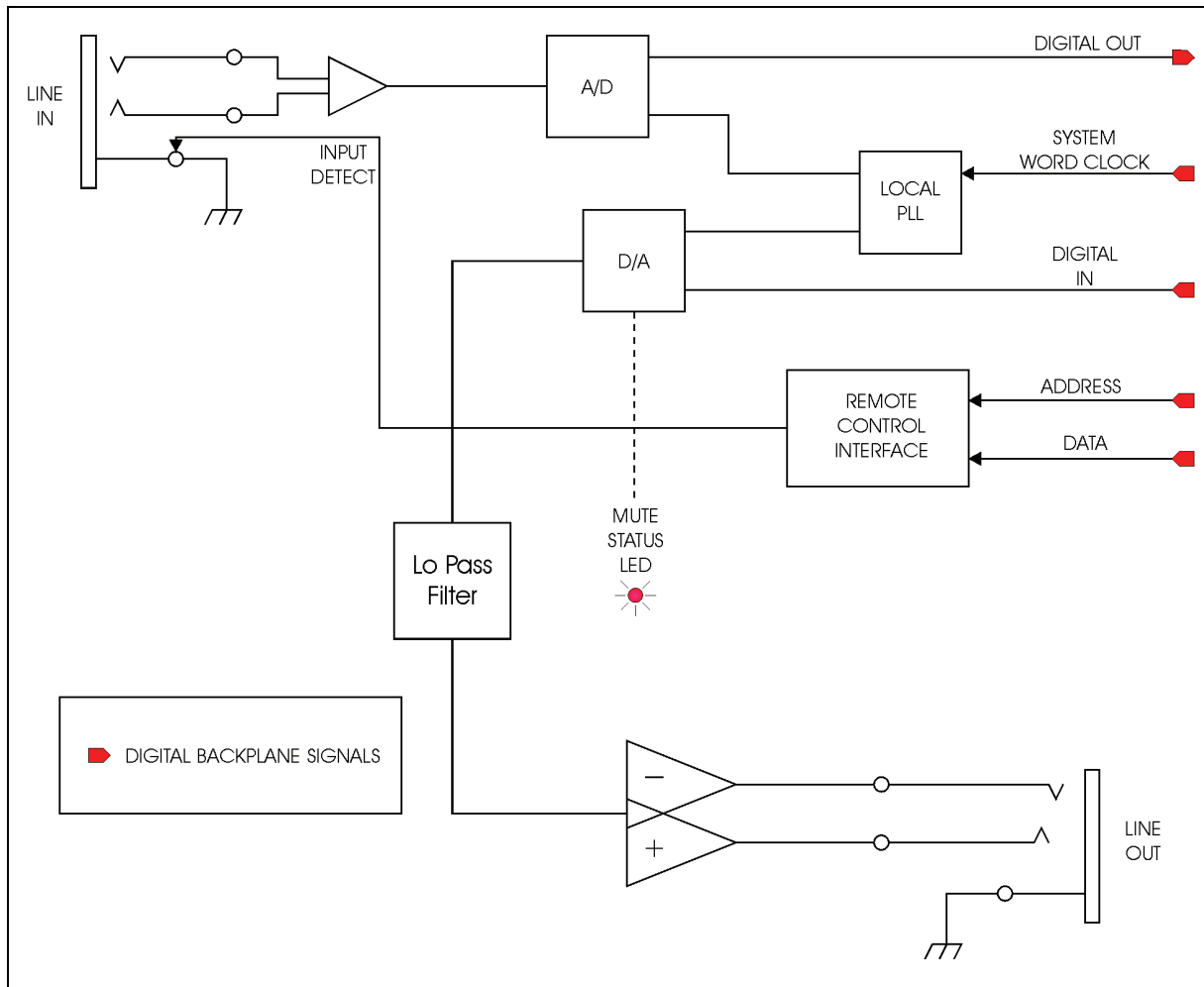

Functional block diagram of the DL443 module

DL444 analogue D-type I/O module

The DL444 D-type I/O module provides a high density analogue I/Os in a compact module. The module incorporates current limited (5mA maximum) and short circuit protected LED outputs, which are independently driven to protect the module from external wiring faults. Status of the module's LEDs can be monitored remotely.

The DL444 D-type I/O module has eight channels of premium mic preamps and eight channels of premium output stage via two standard 25-way, D-type connectors. The mic preamp is in 2.5dB steps, which is similar to the Midas DL431 Mic Splitter, but without the splitting capability.

Each of the eight inputs has a red LED to show the on/off status of its +48V phantom voltage. Similarly, each output has an LED to show whether its mute is on/off. A third 25-way D-type connector lets you view the status of all 16 LEDs remotely.

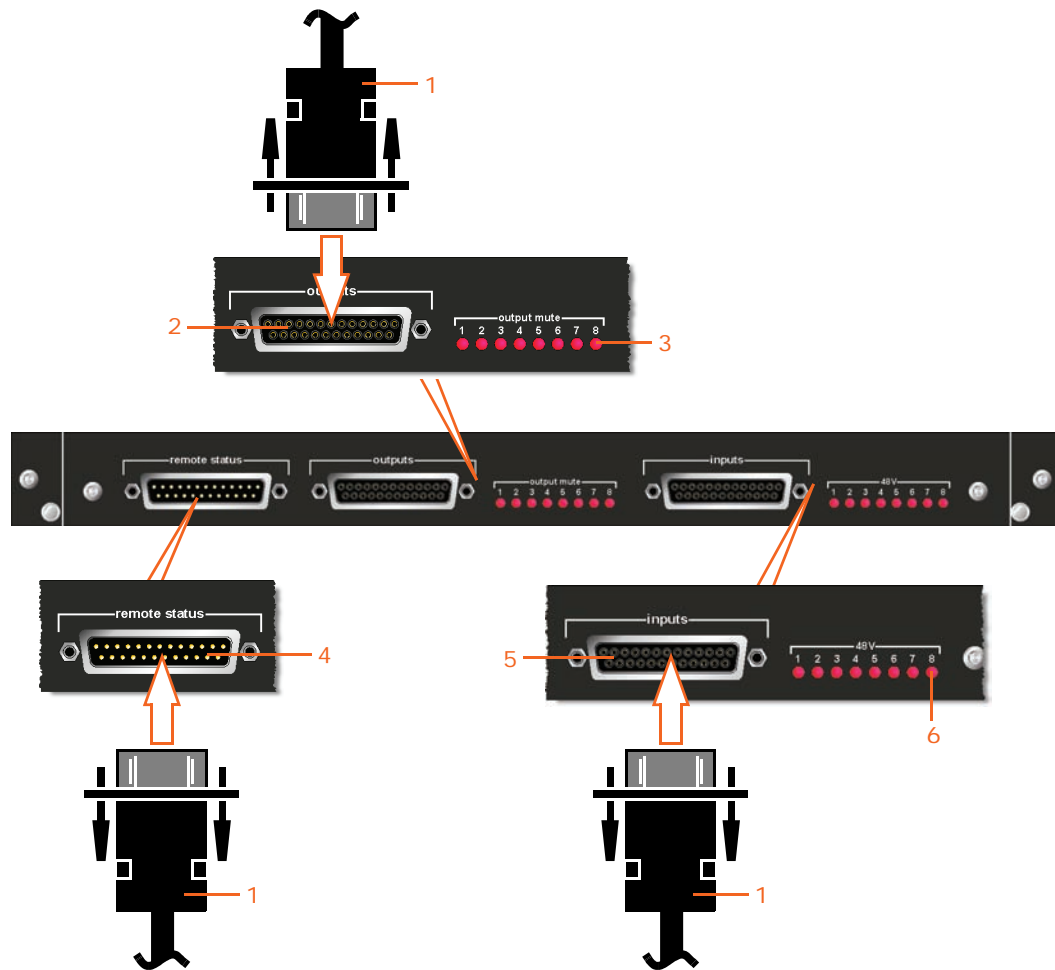

DL444 module connectors

Item	Description
1	Standard D-type connector.
2	outputs D-type socket. This socket connects to up to eight analogue outputs.
3	output mute LED. There are eight output mute LEDs, which show the mute status of each of the eight analogue outputs.

Item	Description
4	remote status D-type socket. This socket is for connecting the I/Os to the 16 red LEDs to provide 48V phantom voltage status and mute status for the inputs and outputs, respectively.
5	inputs D-type socket. This socket connects to up to eight analogue mic/line inputs.
6	48V LED . There are eight 48V LEDs, which show the whether 48V phantom voltage is on/off for each of the eight analogue inputs.

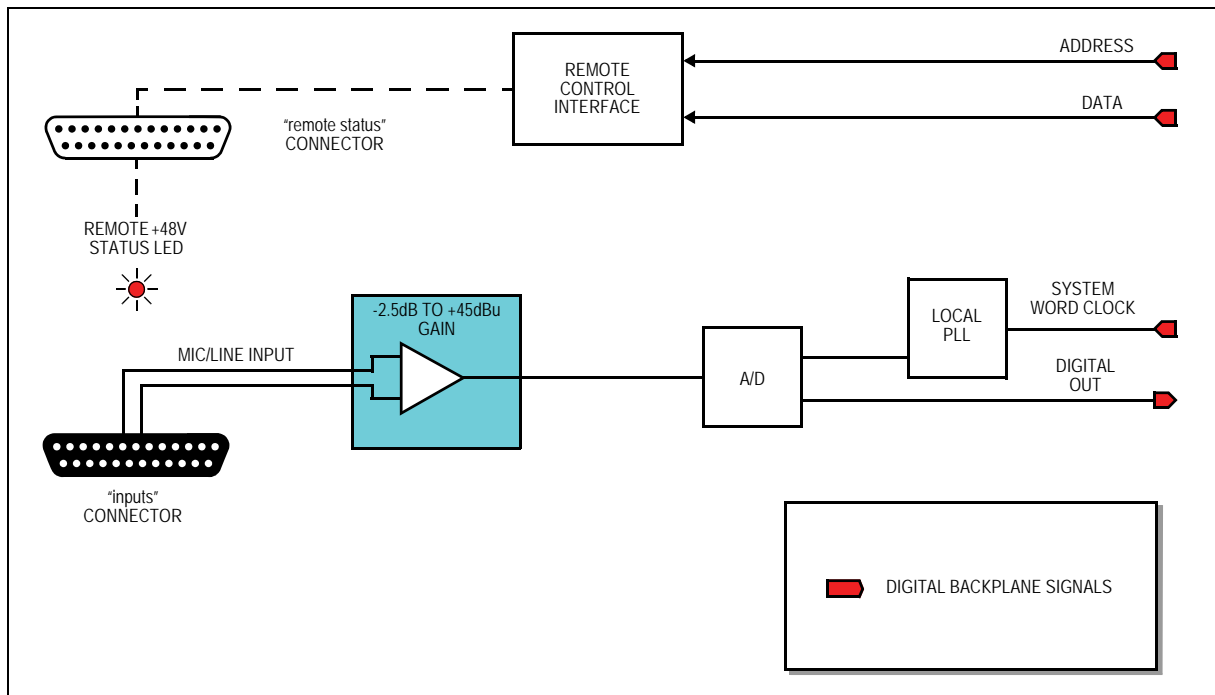

Functional block diagram of the a single (one of eight) analogue input of the DL444 module

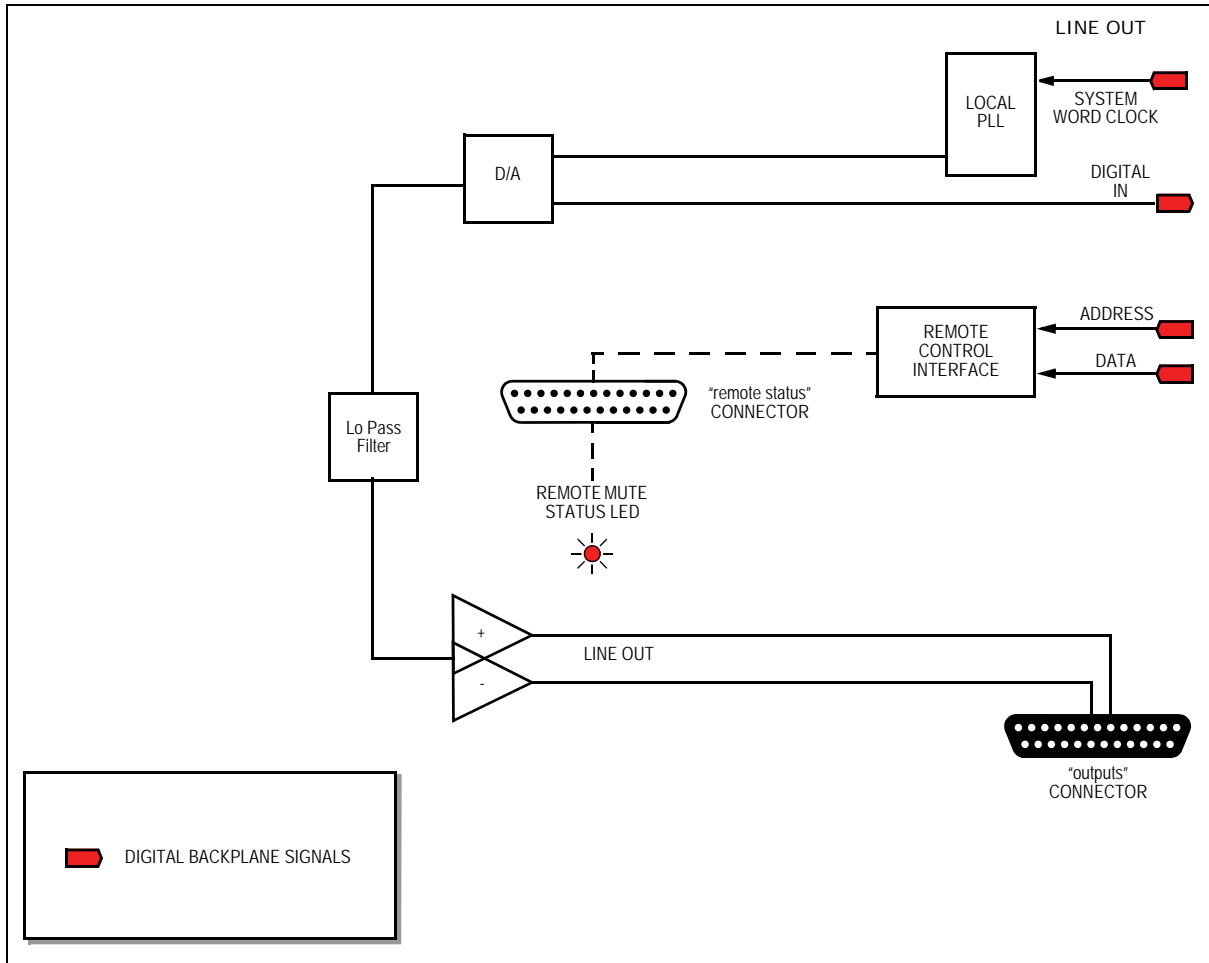

Functional block diagram of a single (one of eight) analogue output of the DL444 module

Connecting to eight XLRs

You can connect either the **inputs** connector or **outputs** connector on the rear panel of the DL444 module to eight XLRs. To do this you will need an adapter cable with a male, 25-way D-type at one end and eight XLRs at the other.

Note: *Off-the-shelf adapter cables are easily obtainable.*

Although generally you will be using XLRs as terminal I/O connections, it will depend on your rack equipment, so these could be jacks, D-types, phonos etc.

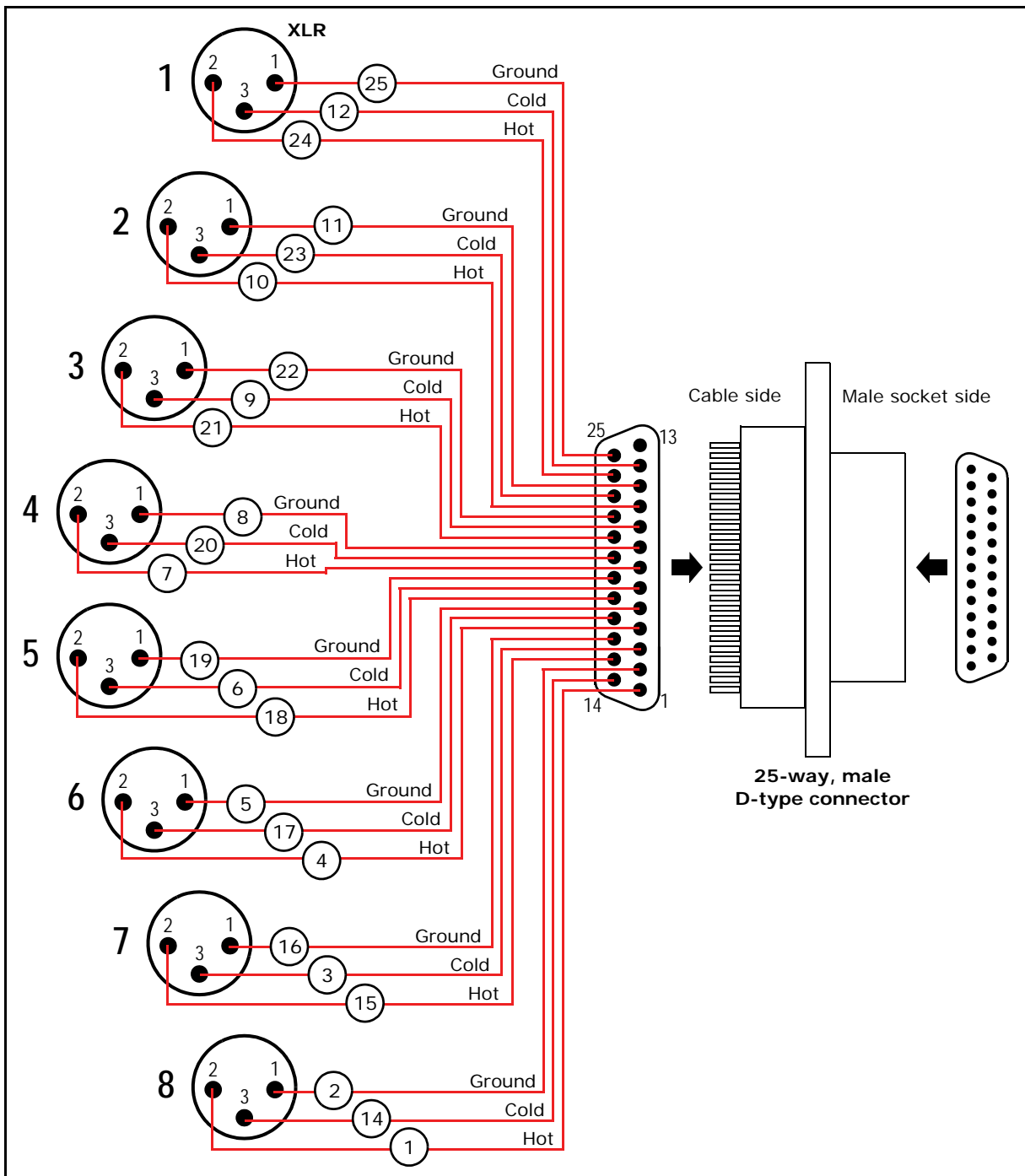

Adapter cable connections for connecting the **inputs** or **outputs** connector to eight XLRs, using the standard "Tascam" pinout configuration.

Pinouts for the remote status connector

Wire up the LED remote status cable as shown below. The LEDs should be suited to a 5mA current.

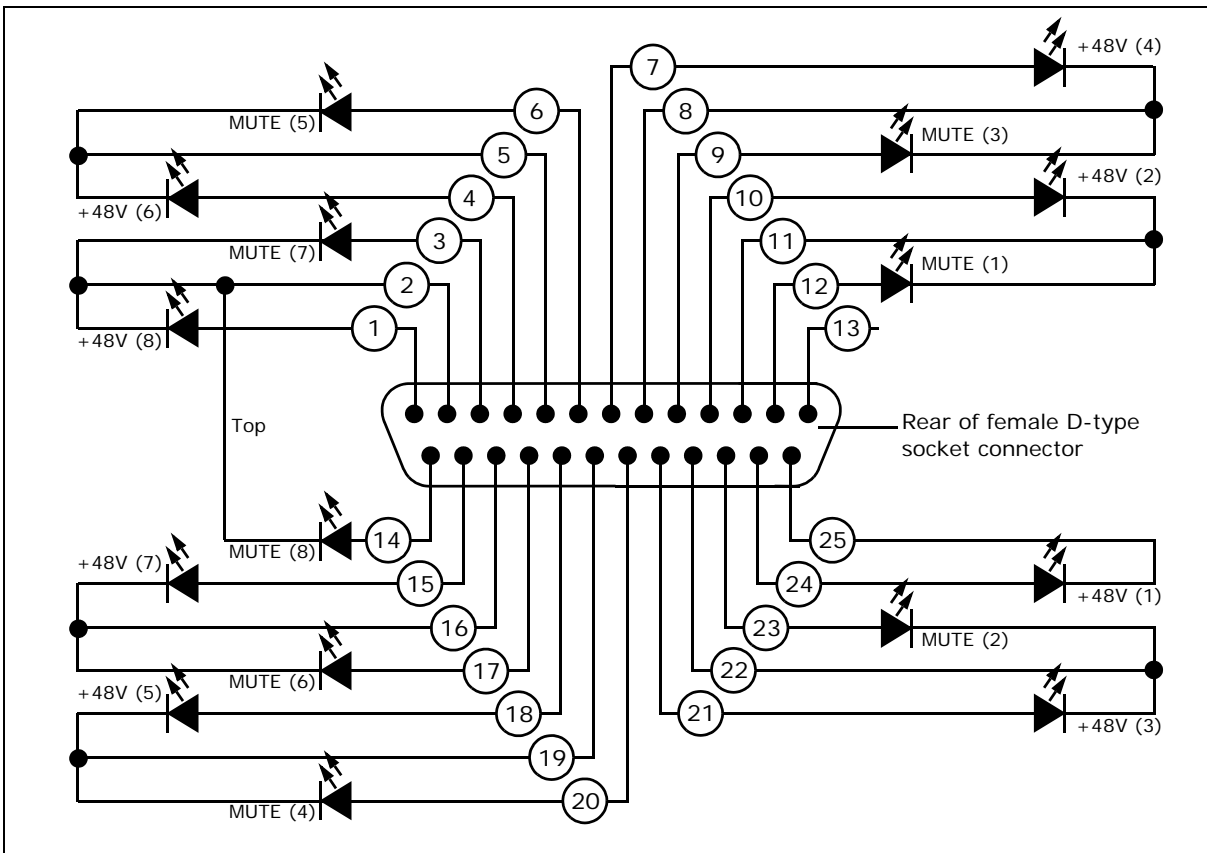

Pinouts for the remote status 25-way D-type chassis connector

DL452 digital I/O module

The DL452 digital I/O module provides four (stereo) AES/EBU inputs and outputs. Its rear panel houses these I/Os in four pairs. Each input has a **check** and a **sync** LED and each output has a **check** and a **mute** LED.

Each AES/EBU input can run at sample rates up to 96kHz (44.1kHz, 48kHz, 88.2kHz and 96kHz) using a sample rate converter (SRC). If the digital input is synchronous with the system clocks, the SRC can be bypassed to remove approximately 1ms of delay, which is inherent in the sample rate conversion process.

Each AES/EBU output can also run at sample rates up to 96kHz by using an (SRC). There are two potential clock sources for the digital outputs: the system and the coinciding digital input. When using the system to drive the digital outputs, the output SRC is bypassed and the sample rate of the output is matched to the system. When the digital input clocks are used to drive the digital outputs, the SRC is enabled and the audio output is converted from the sample rate of the system to the sample rate of the digital input.

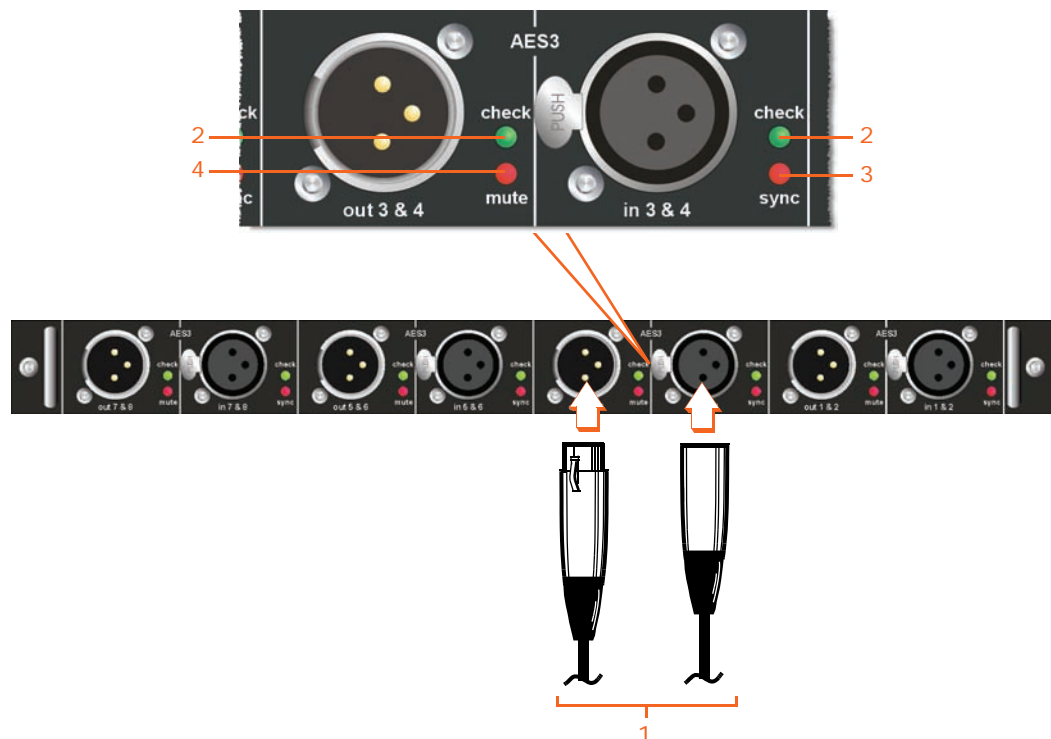

DL452 module connectors

Item	Description
1	Four pairs of digital AES3 (AES/EBU) XLR inputs and outputs.
2	Green check LED illuminates to show when a channel is selected on the console. These are controlled by the console and are used as a visual aid to locate specific connectors.
3	Red sync LED illuminates to show that a valid AES3 connection is present on the digital input.
4	Red mute LED illuminates to show when the channel is muted on the console.

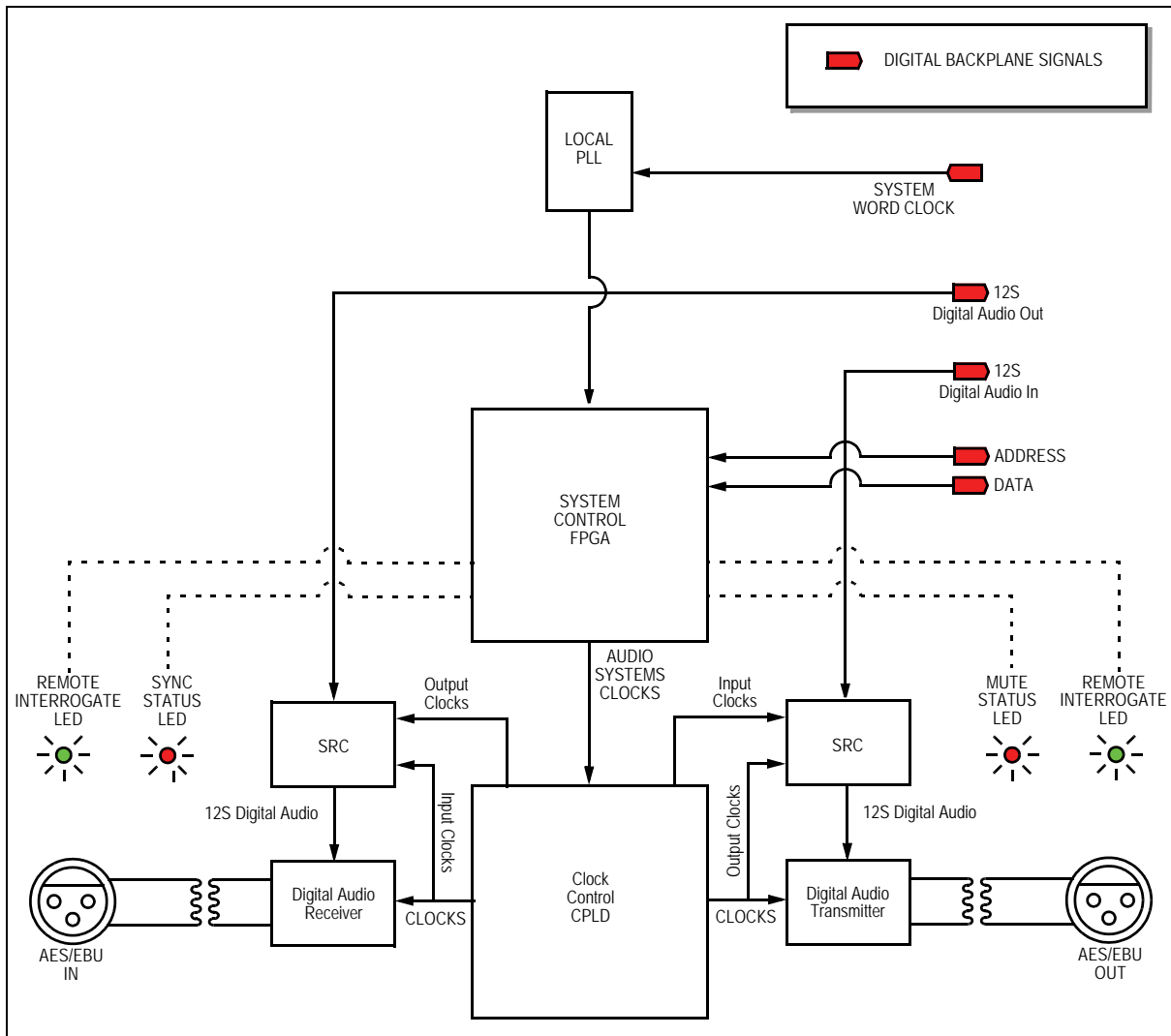

Functional block diagram of the DL452 module showing 1 of 4 channel paths

Appendix F: Replacing A Module

This appendix provides instructions on replacing a module on the rear panel of the PRO Series Control Centre.

Replacing a module

The design of the PRO Series Control Centre makes I/O module replacement very easy and straightforward. The I/O modules are situated at the rightmost side of the rear panel of the PRO Series Control Centre, as shown below.



Typical rear view of the PRO Series Control Centre showing the position of the three slots for the configurable I/O modules

There are three module positions and any of the modules mentioned in Chapter E "I/O Modules" can be fitted. Each position has rack guides so that the modules can slide easily in and out. Each module is securing with two screws.

>> To remove a module

- 1 Switch off and electrically isolate the PRO Series Control Centre, as detailed in "Powering the system" on page 42.
- 2 Remove the two securing screws from the left and right sides of the module you want to remove, as shown in the diagram below.



Position of the module securing screw and circular machined post at either end of a module (rear of PRO Series Control Centre)

- 3 Using both hands, take hold of the circular machined posts and ease the module out of the slot.

>> **To fit a module**

- 1 Make sure the PRO Series Control Centre is switched off and electrically isolated; see "Powering the system" on page 42.
- 2 Offer up the rear of the module to the aperture in the module slot.
- 3 Carefully ease the module into the slot and then push it all the way in until it reaches its fitted position.



Caution:

Be careful not damage the inside of the slot or the module itself by using too much force when pushing the module into the slot. If you feel some resistance, remove the module and try again.

- 4 Switch on the PRO Series Control Centre (see "To switch on the control centre" on page 43) and check that the module is functioning correctly.

The PRO Series Control Centre recognises the type and position of every module in its I/O rack. However, after fitting a new module, you may need to configure some of its options; see Chapter 27 "Changing The User Settings" on page 247.

Appendix G: Troubleshooting

This appendix gives details of problem diagnosis and rectification.

To help guarantee system robustness and reliability — probably the fundamental requirements for live performance consoles — it is imperative to be able to test and diagnose problems with any part of the system easily. The software of the PRO Series has built-in tests to cater for this, but there are also external diagnostic facilities available when these tests are cannot be carried out.

No audio

If you have set up your system and followed all of the instructions for obtaining audio, but you are not hearing anything through the speakers, check the following:

- Make sure the appropriate **ST** buttons in the input fast strips are on (see “Masters sections and pan control” on page 306).
- Make sure the appropriate **ST** buttons in the **source a/b** panels (monitors section of the master bay) are on (see “solo (a and b) sections” on page 148).
- Make sure nothing is muted.
- Make sure no faders are set to minimum.
- Check that the VCA/group master faders are at unity gain.
- Use solo at selected points in the signal path to try and pinpoint where the signal is being lost.
- Check for correct signal routing by making sure channel sources/destinations are correctly assigned.

If you still don't have any audio, contact Midas Technical Support.

Diagnostics

You can view the **Diagnostics** screen to get an overview of the current health and status of the system. The **Diagnostics** screen shows real-time connectivity of the system, the health of connected nodes and whether a device is configured or not. The **Diagnostics** screen also includes a **SWAP HYPERMAC** button for changing the current network from X to Y, and vice versa.



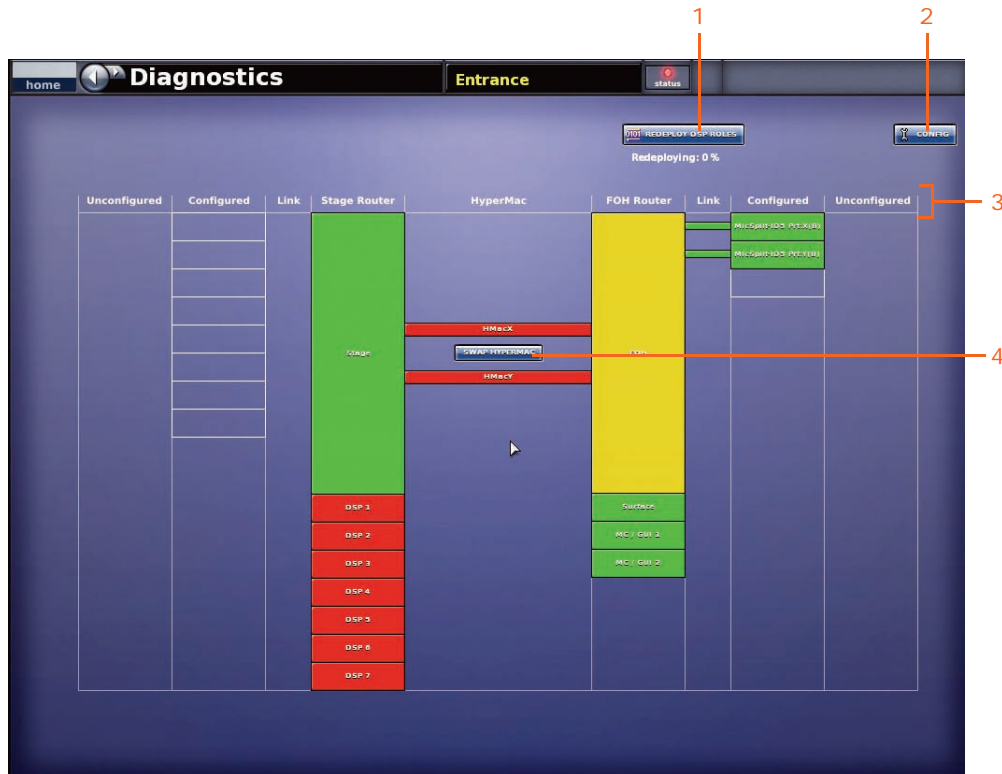

The **status** LED at the top of the screen, which is constantly displayed while the control centre is switched on, is linked to the status of individual items on the **Diagnostics** screen. You can click on it to see what is causing the error.



An example of the **Diagnostics** screen, showing the three types of device condition.

Item	Element	Description
1	REDEPLOY DSP ROLES button	Copies all files to all DSPs. This is usually done after a software upgrade.
2	CONFIG button	Opens the AES50 Device Configuration window (see Figure 14 “Typical AES50 Device Configuration window” on page 92)
3	Column titles	The columns house the following: Unconfigured contains any units that have not been configured during the patching procedure; Configured contains configured units; Link shows the router/unit connection; Stage Router/FOH Router contains the appropriate router and any associated rack units; and HyperMac shows the router/router connections.
4	SWAP HYPERMAC button	Swaps the active network from X to Y and the reverse (see “Swapping the active network” on page 396).

The colour of each device, together with its link (if applicable), indicates its current status, as shown in the following table.

<i>State</i>	<i>Description</i>	<i>Unit status</i>	<i>Connection of active link</i>	<i>Connection of inactive link</i>
	Both the unit and link are green	Good	Good	Good
	Unit is green and the link is red	Good	Bad	Not known
	Unit is red and the link is green	Malfunction	Good	Not known
	Both the unit and link are red	Not known	Bad	Bad

There is also an amber condition, which means that the item(s) is in error, but is not contributing to the audio.

Viewing the status of the master controllers is particularly important, especially when you wish to swap the active master controller (see “Swapping the active master controller” on page 396), as it shows you which master controller is currently controlling the network.

About the Diagnostics Inspector window

Clicking an item in the **Diagnostics** screen will open its **Diagnostics Inspector** window, which provides detailed information, particularly if the item has an error condition.

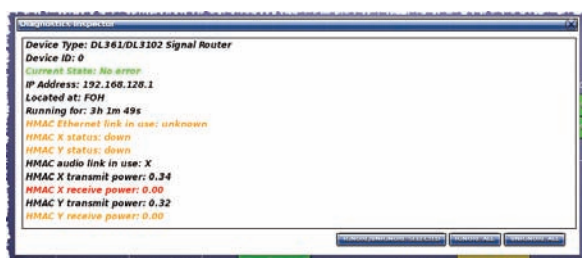

Typical **Diagnostics Inspector** window with the ‘ignore’ buttons at the lower right corner

The ‘ignore’ buttons of the **Diagnostics Inspector** window let you configure the **PRO Series** to ignore errors on selected/all items. This is an important feature because there may be times when you are quite happy to work with a known error(s), but will want to know when a new error occurs.

Note: **Diagnostic Inspector** windows are primarily for use by Midas service and software engineers. By providing useful information, such as device health and status, they aid fault diagnosis and rectification, and may help solve any problems that may arise. Apart from using the ‘ignore’ buttons, it is unlikely that operators of the **PRO Series Control Centre** will ever need to use this function.

Swapping the active network

In the highly unlikely event that the active network (X or Y) develops a malfunction, you can swap over to the standby network, making this the active one.

Note: *The swap function does not swap control data, as this non-audio data finds its own way through the network. This allows the router to swap to the inactive link, even if the active link is broken or removed.*

>> To check the health of the active network

At the GUI, open the **Diagnostics** screen by choosing **home ▶ Diagnostics**, and then check the status of the active HyperMac link. If it is green the link is good, but if it is red there is a problem and you should swap to the standby HyperMac link.

>> To swap the networks

- 1 At the GUI, open the **Diagnostics** screen by choosing **home ▶ Diagnostics**.
- 2 Click **SWAP HYPERMAC**.
- 3 In the prompt window (shown right), click **OK**. The active and standby networks will swap over.

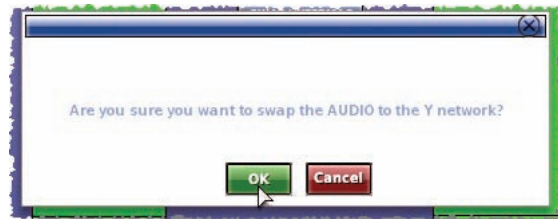

Swapping the active master controller

Although it is highly unlikely that the active master controller (MC) will develop a malfunction, should it ever happen you will need to activate the standby MC.

>> To swap the active master controller

- 1 At the GUI, choose **home ▶ Files**.
- 2 Click **FILE SYNC**.
- 3 In the **Master Controller File Synchronisation** window, click the **MAKE ACTIVE** button of the standby MC (shown below). This will become the active one.

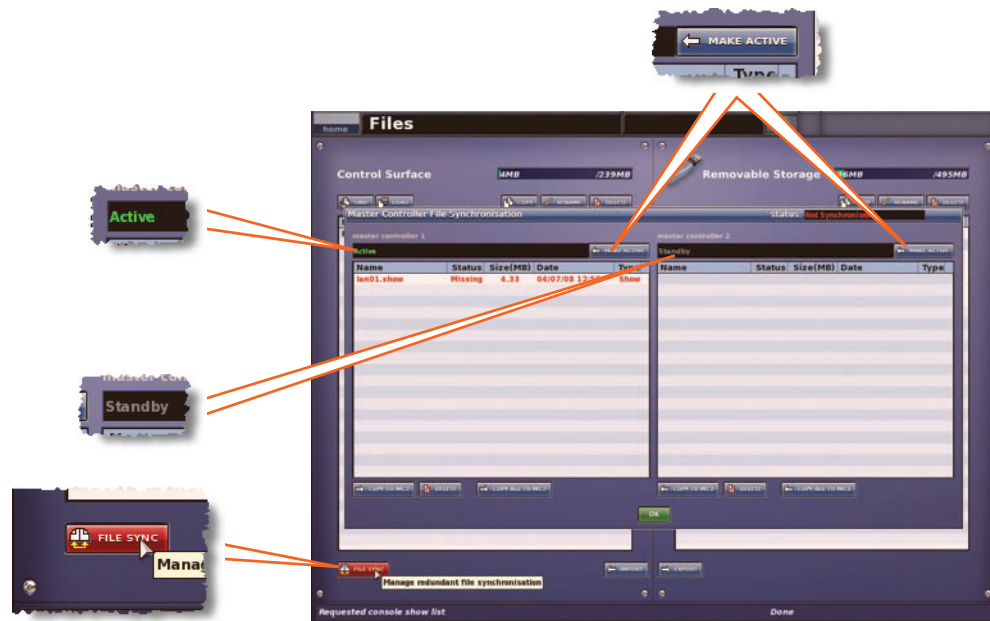

Elements of the **Files** screen and **Master Controller File Synchronisation** window used for swapping the active MC

Synchronising the files

In exceptional circumstances the files may be out of synchronisation. For example, after a new MC has been fitted and the system cannot determine which MC to use. In this case you can choose which files you want synchronised.

>> To choose which file you want synchronised

- 1 At the GUI, choose **home** ▶ **Files**.
- 2 Click **FILE SYNC**.
- 3 In the **Master Controller File Synchronisation** window, click the **MAKE ACTIVE** button of the MC containing the files you want to synchronise.

Mapping a GUI screen to another bay

An important redundancy feature of the control centre lets you map either of the GUI screens to its adjacent bay (mix or master). So, in the unlikely event either of the GUI screens should fail, the other one can take its place if necessary.

>> To re-map a GUI screen

- 1 At the GUI screen you want to re-map, choose **home ▶ Preferences ▶ General**. Current mapping is indicated by the translucent red rectangle. For example, in the diagram right the GUI screen is currently mapped to the mix bay.
- 2 In the **Bay Select** section diagram, click within the other by area. For example, click the master bay (shown right). The red translucent highlight will now move to the master bay.
- 3 Choose **home ▶ Default**.

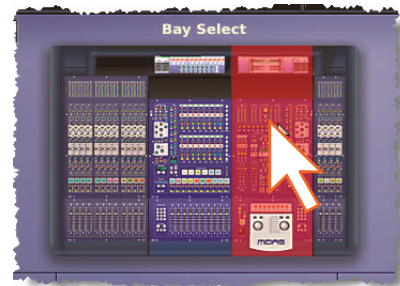
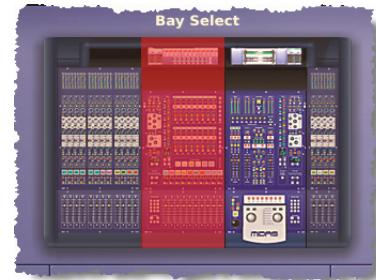

Reset switches



Caution!

Do not operate any of these switches during normal operation, as they are for fault correction purposes only.

There are four reset switches, which are for service use only. They are used for resetting the X and Y master controllers, scan processor and router.

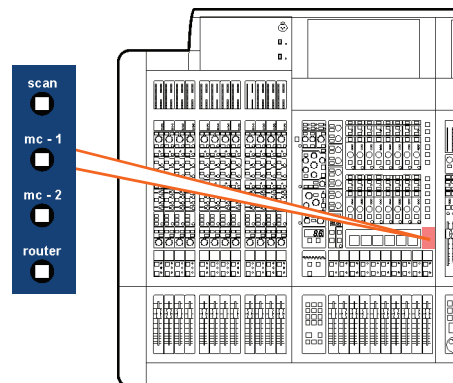

Troubleshooting automation

This section explains the error messages that you may see when using the control centre's automation.

Error messages

Error messages, which can appear when you are accessing the **Files** or **Automation** screens, provide useful information on the condition that triggered them. Due to the way the filing and automation systems interact with the internal processing system of the control centre, not all error messages are indicative of a problem; some may appear due to the current state of the system and just require a retry of the operation.

Error messages comprise two components — a first line of text containing the error condition, followed on the next line by a description of the error (prefixed by the text "response:"). The error condition text indicates the operation that may have triggered the error message, while the error description text explains the reason for failure and, in some cases, also provides information that may be useful to service engineers. The following diagram shows a typical error message.

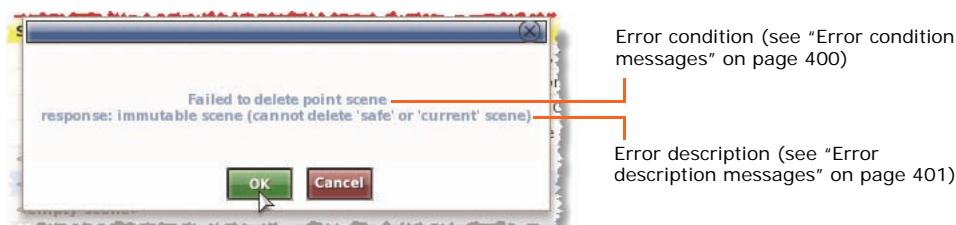

Typical error message window showing the main elements

>> To proceed after an error message appears

- 1 Heed the error message.
- 2 Click **OK**.
- 3 Take the appropriate action for that particular error. Refer to Table 21 "List of error condition messages" on page 400 and Table 22 "List of error description messages" on page 401.

Automation error messages

An automation error message may be generated by any of the following:

- An attempt to perform a copy and paste is ignored.
- Attempting to assign notes to a scene. The text "There was an error setting the scene note" will be displayed.
- An attempt to assign MIDI data to a scene is ignored.
- An attempt to set the navigation mode, that is, switching rehearsal mode on or off, is ignored.
- An attempt to skip/unskip a scene or point scene; see "Rehearsals" on page 210.
- An attempt to assign the default store option is ignored.
- An attempt to assign the rehearsal mode state for all scenes is ignored. (This functionality is not available to the user.)
- An attempt to set the MIDI navigation mode is ignored. (This functionality is not available to the user.)
- An attempt to modify the scene list mode is ignored.

Error condition messages

The following table contains the possible error condition messages for both the file and automation systems. These messages comprise the first line of the error message as they appear on the GUI.

Table 21: List of error condition messages

<i>System Type</i>	<i>Error Message</i>	<i>Fault Condition</i>
File	Failed to copy file	Attempting to copy a file.
File	Failed to delete file	Attempting to delete a file.
File	Failed to rename file	Attempting to rename a file.
Automation	Failed to copy point scene to point scene	Attempting to copy one point scene to another.
Automation	Failed to create a new show	Attempting to create a new show.
Automation	Failed to delete point scene	Attempting to delete a point scene.
Automation	Failed to expand point scene range	Attempting to expand point scene range, that is, by inserting an extra 10 point scenes, for example, expanding scene 10.00 will add point scenes 10.10, 10.20 etc., up to 10.90.
Automation	Failed to initiate point scene storage	Attempting to initiate point scene storage, that is, when clicking Store on the GUI. (A successful outcome is to display the 'Store' window.)
Automation	Failed to insert point scene	Attempting to complete point scene storage by clicking OK after selecting "Insert before scene".
Automation	Failed to load show	Attempting to load a show file.
Automation	Failed to recall last scene	Attempting to recall the previous scene to the control surface.
Automation	Failed to recall Next scene	Attempting to recall the next scene to the control surface.
Automation	Failed to recall Now scene	Attempting to reload the current scene or the current jog scene (if any) to the control surface.
Automation	Failed to rename point scene	Attempting to rename a point scene.
Automation	Failed to save file	Attempting to save a currently loaded file.
Automation	Failed to save file to new name	Attempting to save a currently loaded show file to another file name, that is, by using the Save As button.

<i>System Type</i>	<i>Error Message</i>	<i>Fault Condition</i>
Automation	Failed to store point scene	Attempting to complete point scene storage by clicking OK after selecting "Store to empty scene", "Overwrite scene" or "Store to empty scene".
Automation	Failed to unexpand point scene range	Attempting to unexpand point scene range. This is the opposite of expanding the point scene range (immediately above) and can only be carried out if the 10 point scenes to be unexpanded are empty.

Error description messages

The following table contains the possible error description messages for both the file and automation systems, which will start on the second line of the error message. The "Error Message" column in the table contains the error message text that immediately follows the "response:" text. For ease of reference the table lists the error messages in alphabetical order.

Table 22: List of error description messages

<i>Error Message</i>	<i>System(s)</i>	<i>Problem</i>	<i>Solution</i>
hexadecimal number			
<error code in hexadecimal> unknown error code	File and Automation	Indication of a possible system error.	Note down the hexadecimal value of the error code and contact Midas Technical Support, giving them this value.
a			
artefact clone policy violation	File and Automation	The cloning of this artefact (file type) is not allowed.	Avoid using this type of operation.
artefact creation policy violation	File and Automation	The creation of this file type is not allowed.	Avoid using this type of operation.
artefact deletion policy violation	File and Automation	The deleting of this file type is not allowed.	Avoid using this type of operation.
artefact import violation	File and Automation	The importing of this file type is not allowed.	Avoid using this type of operation.
artefact load policy violation	File and Automation	The loading of this file type is not allowed.	Avoid using this type of operation.
artefact rename policy violation	File and Automation	The renaming of this file type is not allowed.	Avoid using this type of operation.
artefact replication policy violation	File and Automation	The replication of this file type is not allowed.	Avoid using this type of operation.
artefact save policy violation	File and Automation	The saving of this file type is not allowed.	Avoid using this type of operation.
attempt to overwrite existing data (overwrite not enabled)	File and Automation	The operation to save or copy to the existing file is not allowed, as files cannot be overwritten.	Avoid using this type of operation.

<i>Error Message</i>	<i>System(s)</i>	<i>Problem</i>	<i>Solution</i>
b			
bad device	File and Automation	Operation could not be carried out because the device, that is, the internal compact flash of the PRO Series or USB memory stick (if connected), does not contain the required directory structure.	<ul style="list-style-type: none"> • If the device is the internal compact flash of the PRO Series, this could be an indication of a serious problem. Contact Midas Technical Support. • If the device is the USB memory stick, check that the device has not been disconnected from the control surface.
bad device ID	File and Automation	The device identifier has not been recognised.	If you are exporting a file to a USB memory stick, check that it has not been disconnected from the control surface.
bad directory	File and Automation	The file system path does not terminate in a directory.	This is highly unlikely to occur in practice, but is an indication of a serious error. Contact Midas Technical Support.
bad file	File and Automation	The file system path does not terminate in a file.	This is highly unlikely to occur in practice, but is an indication of a serious error. Contact Midas Technical Support.
bad file artefact	File and Automation	The file has been detected as not valid. Preferences, preset library and show files are validated by comparing their actual attributes against the corresponding fields stored in the header of the file, such as, file size, checksum etc.	Try again. If still unsuccessful, and if the file is a show file, try a backup file, if one is available.
bad file version	File and Automation	The preferences, preset library or show file could not be opened because its file header version field was not valid.	Try again. If still unsuccessful, and if the file is a show file, try a backup file, if one is available.
bad path	File and Automation	A file or directory is missing.	This is an indication of a serious error. Contact Midas Technical Support.
bad point scene ID	File and Automation	The scene's point scene ID cannot be found.	Try again.

<i>Error Message</i>	<i>System(s)</i>	<i>Problem</i>	<i>Solution</i>
c			
c-lib file error	File and Automation	Critical internal error.	This is an indication of a serious error. Contact Midas Technical Support.
c-lib error	File and Automation	Critical internal error.	This is an indication of a serious error. Contact Midas Technical Support.
c-lib process error	File and Automation	Critical internal error.	This is an indication of a serious error. Contact Midas Technical Support.
d			
device utilisation policy violation	File and Automation	The device is full.	If necessary, backup some files and delete them from the device to free up some memory.
e			
empty point scene index	File and Automation	An attempt was made to navigate an empty point scene index.	Try again. If unsuccessful, and if the file is a show file, try a backup file, if one is available.
event is already active	Automation	Critical internal error.	This is an indication of a serious error. Contact Midas Technical Support.
f			
failed to add to lock list	File	A device or file could not be 'locked' to prevent another task accessing it while it is in use.	Although, in practice, it is highly unlikely to occur, this error may indicate a serious system failure. Contact Midas Technical Support.
failed to add scene	File and Automation	The scene could not be added.	Try again.
failed to allocate memory	Automation	The MC was unable to allocate sufficient memory (RAM) to complete the task.	Switch off the PRO Series Control Centre and switch it back on again. If the problem persists, it could be an indication of a serious error. Contact Midas Technical Support.
failed to configure scope mask	Automation	The 'copy and paste through scenes' operation failed.	Try again. If repeated attempts fail, contact Midas Technical Support.
failed to create show	Automation	A new show could not be created.	Try again. If repeated attempts fail, contact Midas Technical Support.
failed to deschedule event	Automation	Critical internal error.	This is an indication of a serious error. Contact Midas Technical Support.
failed to schedule event	Automation	Critical internal error.	This is an indication of a serious error. Contact Midas Technical Support.

<i>Error Message</i>	<i>System(s)</i>	<i>Problem</i>	<i>Solution</i>
i			
immutable scene (cannot delete 'safe' or 'current' scene)	File and Automation	The operation on the current or safe scene is not allowed. The safe scene cannot be edited or deleted and you cannot store to it. Also, you cannot delete the scene last recalled to the control surface. (Precludes the use of the Now button.)	Avoid using these types of operation.
j			
jog position is empty	Automation	The current scene is empty.	Avoid this type of operation on an empty scene.
m			
missing file	File and Automation	The required file cannot be found.	Try again.
missing navigation state	Automation	Critical internal error.	This is an indication of a serious error. Contact Midas Technical Support.
mtools lookup	File and Automation	Critical internal error.	This is an indication of a serious error. Contact Midas Technical Support.
n			
no CBMA access	Automation	Automation manager does not have access to the current control surface settings.	Try again or try switching off the PRO Series Control Centre and then switching it back on again. If the problem persists, contact Midas Technical Support.
no next scene	Automation	There is no next scene relative to the current position in the scene list. This is generated by recalling the next scene when the current scene is the last in the scene list.	Avoid this operation on the last scene in the cue list.
no previous scene	Automation	There is no previous scene relative to the current position in the scene list. This is generated by recall the last scene when the current scene is 00.00, that is, the safe scene.	Avoid this operation on the safe scene.
no scene data	Automation	The scene contains no scene notes or MIDI data.	Only carry out this type of operation on a scene that contains scene notes or MIDI data.
no show loaded	Automation	There is no show loaded.	Only carry out this type of operation with a show loaded.

<i>Error Message</i>	<i>System(s)</i>	<i>Problem</i>	<i>Solution</i>
not in storing state	Automation	The Automation System was momentarily unable to store a scene.	Try again. If repeated attempts fail, contact Midas Technical Support.
null pointer	File and Automation	Critical internal error.	This is an indication of a serious error. Contact Midas Technical Support.
p			
persistent storage error	File and Automation	The GUI or one of its subsystems is out of date and cannot interpret the new failure modes.	Update the GUI and its subsystems. If the problem persists, contact Midas Technical Support.
point scene index continuity error	File and Automation	The show file being modified is damaged.	This is an indication of a serious error. Contact Midas Technical Support.
point scene index integrity error	File and Automation	The show file being modified is damaged.	This is an indication of a serious error. Contact Midas Technical Support.
point scene insert error	File and Automation	Failed to insert a point scene.	This is highly unlikely to occur in practice, but is an indication of a serious error. Contact Midas Technical Support.
portable scene format conversion error	Automation	The attempt to load a show, which was last saved by an MC built with a different enum version, failed during the scene conversion stage of the loading process.	Try again. If repeated attempts fail, contact Midas Technical Support.
r			
required device has files that are in use	File and Automation	Another task is currently accessing file(s) on the device, that is, the internal compact flash of the PRO Series or USB memory stick (if connected).	Try again.
required device is locked	File and Automation	Another task is currently accessing the device, that is, the internal compact flash of the PRO Series or USB memory stick (if connected).	Try again.
s			
scene capacity violation	File and Automation	The scene cannot be stored to the show file, as it already contains the maximum number of scenes allowed.	If necessary, delete one or more of the other scenes. The maximum capacity for a show file is 500 scenes for a 512MB master controller (MC) and 1000 scenes for a 1GB MC.
scene UID error	File and Automation	The file being modified is damaged.	This is an indication of a serious error. Contact Midas Technical Support.

Error Message	System(s)	Problem	Solution
shell command error	File and Automation	This is a critical internal error.	This is an indication of a serious error. Contact Midas Technical Support.
source point scene is empty	Automation	Specified source scene is an empty 'slot'.	Only carry out this type of operation on a scene that is not empty.
specified file is already locked	File and Automation	Another task is currently accessing the file	Try again.
specified file was not found	File and Automation	The file could not be found on the specified device, that is, the internal compact flash of the PRO Series or USB memory stick (if connected).	<ul style="list-style-type: none"> • If the device is the internal compact flash of the PRO Series, this could be an indication of a serious problem. Contact Midas Technical Support. • If the device is the USB memory stick, check that the device has not been disconnected from the control surface.
stdio stream error	File and Automation	This is a critical internal error.	This is an indication of a serious error. Contact Midas Technical Support.
stdio stream open error	File and Automation	This is a critical internal error.	This is an indication of a serious error. Contact Midas Technical Support.
stdio stream seek error	File and Automation	This is a critical internal error.	This is an indication of a serious error. Contact Midas Technical Support.
storage policy violation	File and Automation	There has been a 'storage policy' violation. (This is not necessarily a critical error.)	Ensure that all software components are up to date. If the problem persists Contact Midas Technical Support.
t			
the <file/automation> manager is not registered	File and Automation	The System Manager is momentarily unavailable.	Try again.
u			
unknown parameter enum value	Automation	A parameter with a value that was not valid was supplied to the MC.	Try again. If this occurs again, contact Midas Technical Support.

Appendix H: Updating PRO Series Host Software

This appendix shows you how to update the host software of the PRO Series and also its associated networked devices.

About the PRO Series updater

The PRO Series has an update facility that provides an easy and straightforward method of updating your system by letting you install the latest version of host software on the PRO Series Control Centre and also any networked DLnnn units.

Basically, all you have to do is insert a memory stick containing a file of the latest version of host software, select this file via the updater option from the GUI menu and then start the updater. The updater then installs the latest host software on the control centre and any DLnnn units connected in the system, while displaying the progress on the special updater screen. When the updater has finished and you have exited from the updater screen, the PRO Series Control Centre will automatically power cycle for the upgrade to take effect. Your system should now be fully up to date.

By using the updater, you can install an earlier version of the host software on your system if you should ever need to.

About the updater screen

During installation the updater screen will appear. This screen lets you select the system devices you want to upgrade and then start the update procedure. During the update, it shows you how the procedure is progressing.

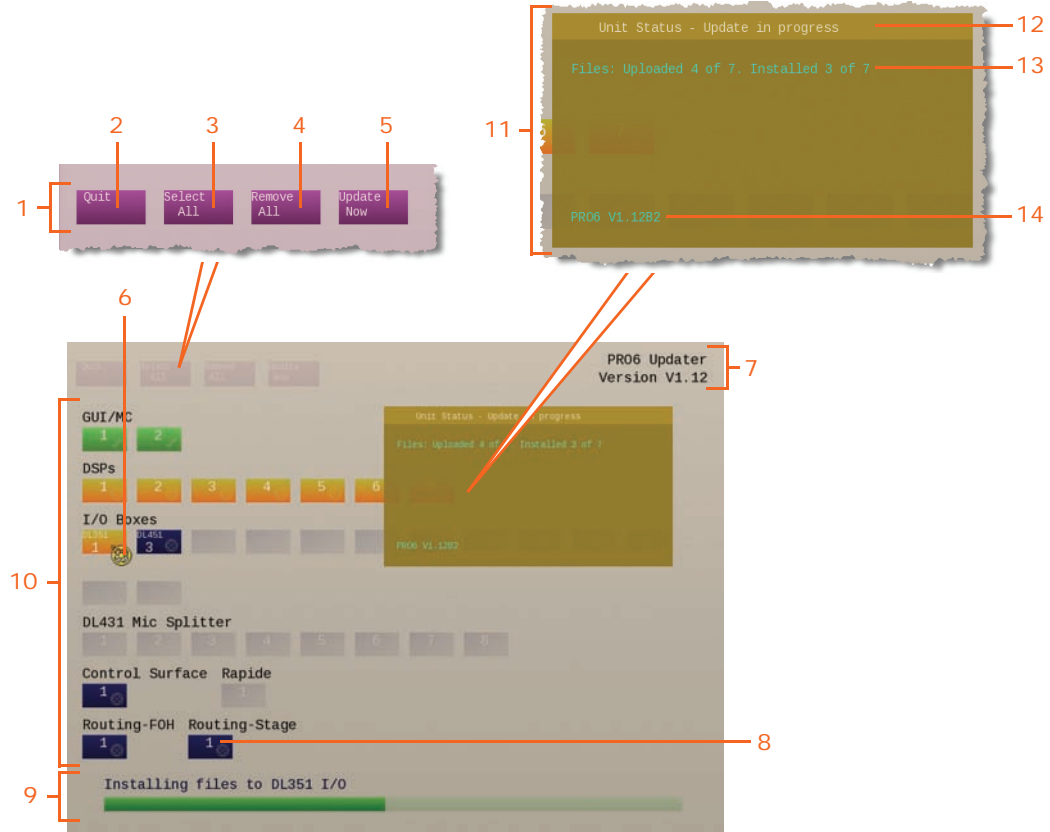











Figure 43: A typical updater display

Item	Element	Description
1	Menu	Updater menu.
2	Quit button	This updater menu button exits the updater.
3	Select All button	This updater menu button selects all Midas devices connected (and detected) in the PRO Series Live Audio System.
4	Remove All button	This updater menu button deselects all selected Midas devices connected (and detected) in the PRO Series Live Audio System.
5	Update Now button	This updater menu button starts the update procedure.
6	Pointer	The shape of the pointer is an arrowhead  , but this changes to a rotating roundel  during the update procedure.
7	Updater version information	Shows you the PRO Series host software version that the system will be updated to.
8	Device block	See Table 23 below.

<i>Item</i>	<i>Element</i>	<i>Description</i>
9	Status bar	This green bar shows the progress of the current task in the update procedure, as indicated by the text immediately above.
10	Device area	This area contains device blocks that each represent an item of equipment in the PRO Series Live Audio System.
11	Unit Status window	This window, which opens when you move the pointer over a device, gives you detailed information on the device's update progress.
12	Text	Window name followed by device update status information.
13	Text	Detailed file information and installation status.
14	Text	Shows the build that the device will be updated to.

Each device block on the updater screen represents a possible or actual device connected in the system. The number inside the device block is the device's ID, and the colour of each device block indicates its update status. The following table explains what each device block condition represents.

Table 23: Description of the updater screen device blocks

<i>Device block</i>	<i>Description</i>
	Grey background — appears during the updater's 'triggering upgrade client' procedure. If its appearance doesn't change throughout the update procedure, either there is no device connected in this position or one has not been detected.
	Blue background without roundel — appears after the updater's 'triggering upgrade client' procedure has finished to show you that there is a device connected in this position.
	Dark blue background with roundel — appears after this device has been selected for update.
	Gold background with roundel — this device is currently being updated.
	Green background — this device has successfully been updated.
	Red background — this device's update has failed.
	This is an I/O device block, which has the unit type at the top.

Using the PRO Series updater

This section shows you how to update your PRO Series Live Audio System. However, before you begin there are a few things you will need and some things you must do.

What you will need

Before you begin, check that you have the following:

- **USB memory stick** The USB memory stick (flash drive) must have enough memory to store any shows that you will need to backup, plus an additional 150MB of memory for the update package (that is, the file with a .tar extension). It should also preferably be of USB 2.0 specification.
- **Stable mains supply** If the power drops at a critical point during the update, it is possible — although unlikely — that this could cause some of the system components not to function. A warning window opens before you start the update procedure to remind you of this.

Preparation

Before you begin, do the following:

- **Backup your shows** It is likely that any shows will be erased when you power cycle the PRO Series Control Centre following an update. We therefore recommend that you backup your shows onto the USB memory stick (see “Saving your show files to a USB memory stick” on page 123), and then copy them onto a PC. You will be given the chance to do this during the update procedure, just before the update begins.
- **Check that everything is connected** Make sure that everything on the system is correctly connected, configured and functioning properly. Do this by checking the **Diagnostics** screen (see “Diagnostics” on page 393).
- **Switch off speakers** During the update procedure the DSP and AES routing may perform a number of resets during which the audio may not be in a controlled state. We therefore recommend that you switch off any speakers connected to the system.
- **Make sure you have enough time** The update procedure may take quite a while to complete, so make sure you have enough time before you start; a warning window during the update procedure will remind you of this. We do not recommend carrying out an update just before a performance.
- **Configure the USB memory stick** Create a folder at the top level (root directory) of your USB memory stick called “DL3Upgrades”. Then, copy the latest update file (DL3xxx.tar) into it.

Updating your system



WARNING!
UPGRADING YOUR SYSTEM WILL CAUSE THE CONSOLE TO LOSE SYNCHRONISATION, WHICH CAN RESULT IN LOUD NOISES FROM THE SYSTEM. ALWAYS MUTE THE PA AT THE AMPLIFIER/SPEAKER BEFORE UPDATING YOUR SYSTEM.



Caution!
Do not switch off the power to any of the system devices while the PRO Series Control Centre is carrying out the installation of the host software.

The installation process is carried out with the PRO Series Control Centre fully powered up and operational.

>> To update your PRO Series Live Audio System with the latest version of host software

- 1 Mute the PA at the amplifier/speaker. Refer to the **WARNING** at the beginning of this section.
- 2 Insert the USB memory stick into the active USB socket of the PRO Series Control Centre (see "Saving your show files to a USB memory stick" on page 123).
- 3 Depending on how many .tar files there are in the "DL3Upgrades" folder of the USB memory stick, one of the following will happen:

- **One .tar file** The "Run upgrade utility?" window (shown right) will open.
- **More than one .tar file** The multiple upgrades window will open, which contains the text: "Multiple Upgrades found. Select the required upgrade from the Preferences> Upgrade menu".



- 4 Do one of the following:
 - In the "Run upgrade utility?" window, click **OK**. (Clicking **Cancel** will cancel the update procedure.)
 - In the multiple upgrades window, click **OK**. Then, at the appropriate GUI screen, choose **home ▶ Preferences ▶ Upgrade** and click on the latest host software .tar file (as shown right).



- 5 The updater will be launched, displaying the following in the upper-left corner of the screen.

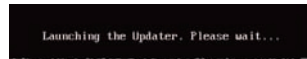

The "PREPARING UPDATER" screen will open, and the status bar text will inform you of the updater progress.

When the updater preparation has finished (as shown right) the status bar text will read "Select items for upgrade".

- 6 Select the devices you want to update by doing any of the following:
 - **Select all** It is most likely that you will want to select all of the devices, so click **Select All**.
 - **Select a single device** To select a single device, click its device block.
 - **Deselect a single device** To deselect a selected device, click its device block.
 - **Deselect all** To deselect all selected devices, click **Remove All**.

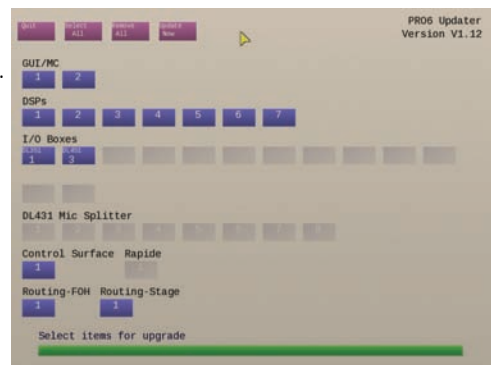

- 7 Click **Update Now**. The following warning window will open.

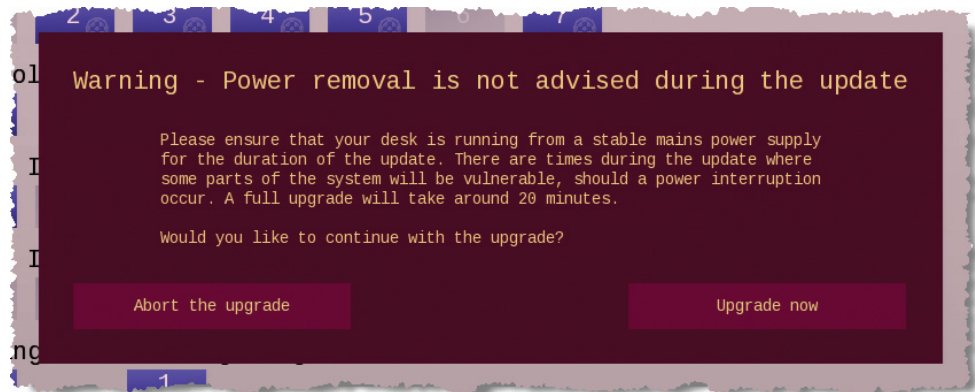

Window with a warning about the mains power supply. Please read and observe before continuing with the update procedure.

- 8 Click **Upgrade now**.

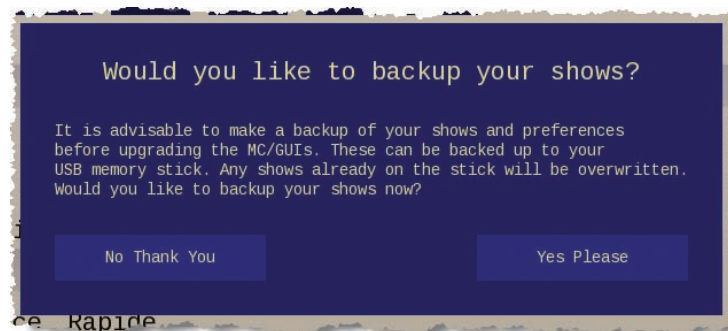

Window asking about backing up your shows and preferences

- 9 Do one of the following:
- To continue without backing up your shows/preferences, click **No Thank You**.



Caution!
Backing up your shows at this point by clicking Yes Please overwrites any existing shows (.tar files) on your USB memory stick, even if they are for other types of Midas digital consoles.

- If you want to back up your shows/preferences, click **Yes Please** (see **Caution** above). The PRO Series Control Centre will automatically write its show/preferences files to the USB memory stick, overwriting any existing ones.

The update procedure will then automatically start by uploading files to the GUI/MC (as shown right).

During the update procedure, leave all of the system devices switched on (see the **Caution** at the start of this section).

Throughout the update procedure the device blocks will change colour according to their update status (see Table 23 “Description of the updater screen device blocks” on page 409). The status bar will show the progress of the current action.

When the update procedure has finished, an **Upgrade complete** window will open (as shown right).

- 10 Click **Ok** to close the **Upgrade complete** window.
- 11 Click **Quit**. The PRO Series Control Centre and all the units will return to normal operating mode.
If any units have failed to update, instead of clicking **Quit** you can select them and start the update procedure again.
- 12 Power cycle the system by switching the PRO Series Control Centre and all of the system units off and then on again.
- 13 When the system has powered up fully and the control centre is ready for normal operation, repeat step 12 to ensure that the licensing system is enabled.

>> To update your PRO Series Live Audio System with a previous version of host software

The procedure is the same as if you are installing the latest version of host software (as detailed above), just select the file of the older software version you want from the **home ▶ Preferences ▶ Upgrade** submenu instead of the latest one.



Appendix I: Documentation

This chapter gives details of all the user and supplementary documentation for the PRO Series Live Audio Systems.

All of the documents mentioned in this chapter are currently supplied with the PRO Series Live Audio Systems. They are supplied electronically in portable document format (PDF) on appropriate media.

System user documentation

The following table shows the full suite of Midas PRO Series Live Audio System documentation.

<i>Document Name</i>	<i>Description</i>	<i>Part Number</i>
PRO Series Live Audio Systems Owner's Manual	Full user instructions for the PRO Series Live Audio Systems (PRO3, PRO6 and PRO9).	DOC02-PROSERIES
PRO3 Control Centre Quick Reference Guide	Contains quick system set-up and operation instructions for the PRO3 Control Centre.	DOC04-PRO3
PRO6 Control Centre Quick Reference Guide	Contains quick system set-up and operation instructions for the PRO6 Control Centre.	DOC04-PRO6
PRO9 Control Centre Quick Reference Guide	Contains quick system set-up and operation instructions for the PRO9 Control Centre.	DOC04-PRO9
DL251 Audio System I/O Operator Manual	Full user instructions for the DL251 Audio System I/O.	DOC02-DL251
DL351 Modular I/O Operator Manual	Full user instructions for the DL351 Modular I/O.	DOC02-DL351
DL371 Audio System Engine Operator Manual	Full user instructions for the DL371 Audio System Engine.	DOC02-DL371
DL431 Mic Splitter Operator Manual	Full user instructions for the DL431 Mic Splitter.	DOC02-DL431
DL451 Modular I/O Operator Manual	Full user instructions for the DL451 Modular I/O.	DOC02-DL451
GNU General Public License (GPL) Booklet	Licensing information for Midas Digital Equipment.	DOC04-GPL

Supplementary documentation

This section lists all the supplementary documentation available for the PRO Series Live Audio Systems, which comprises manuals from the standard Midas and Klark Teknik range of products. These documents are included as reference material to accompany the PRO Series user documentation, particularly for the GEOs and internal effects.

- Klark Teknik DN370 Graphic Equaliser Operator Manual, part number DOC02-DN370C.
- Klark Teknik DN780 Digital Reverberator/Processor Operator Manual.
- Klark Teknik Square ONE Dynamics Processor Operator Manual, part number DOC02-SQ1DYNAMIC.
- Klark Teknik DN9331 Rapide Graphic Controller Operator Manual, part number DOC02-DN9331.
- Klark Teknik DN9696 Recorder Operator Manual, part number DOC02-DN9696HM.

Appendix J: Reference Tables

This appendix contains tables that may provide a useful reference.

Definition of the primary buses

The primary buses are shown in the following table.

Table 24: Definition of primary buses

<i>Bus</i>	<i>Description and option</i>	<i>Source and destination</i>
Aux	<ul style="list-style-type: none"> • Mono aux mix pairs (contributions taken pre-/post-fader, level and level) • Stereo aux mix pairs (contributions taken pre-/post-fader with own level and pan) • Subgroup style single (contributions taken post-fader, mono) • Subgroup style pairs (contributions taken post-fader, main pan stereo) • Mix minus style single (contributions taken post-fader, mono) • Mix minus style pairs (contributions taken post-main, pan stereo) 	From inputs (including aux inputs set to input channel mode) to aux sends in the mix area
Matrix	<ul style="list-style-type: none"> • Matrix mix mono pairs (contributions taken pre-/post-fader, level and level) • Matrix mix stereo pairs (contributions taken pre-/post-fader with own level and pan) • Optional 5:1 subgroups 	From inputs, auxes and masters to matrix outputs in the mix area
Master	<ul style="list-style-type: none"> • Master group style single (post-fader mono) • Master group style pair (post-fader, pan stereo) • Master SIS style (contribution is taken post-pan and image SIS) 	From inputs and auxes to master outputs (master area)
Solo	<ul style="list-style-type: none"> • PFL stereo (or spread centre-panned mono) • AFL stereo (or spread centre-panned mono) • Optional 5:1 	From anywhere to the monitor outputs (master area)

Navigating to the Patching screen

The following table shows you how to access the **Patching** screen from various other GUI screen locations.

Table 25: Navigating to the Patching screen

<i>Channel or signal type</i>	<i>Location on GUI screen area</i>	<i>Button legend</i>	<i>Page ref.</i>	<i>Opens the tab sheet in the ...</i>	
				<i>From section</i>	<i>To section</i>
Input channel	Compressor processing area - side chain section	MENU	281	Not affected	Sidechains
Input channel	Compressor processing area	source	281	Not affected	Sidechains
Input channel	Gate processing area - side chain section	MENU	281	Not affected	Sidechains
Input channel	Gate processing area	source	281	Not affected	Sidechains
Input channel	Insert processing area	dest	281	Ins. Sends	Not affected
Input channel	Insert processing area	source	281	Not affected	Ins. Ret.
Input channel	Configuration processing area	source	281	Not affected	Inputs
Input channel	Configuration processing area - direct output section	dest	281	Dir. Out	Not affected
Return channel	Insert processing area	dest	316	Ins. Sends	Not affected
Return channel	Insert processing area	source	316	Not affected	Ins. Ret.
Return channel	Configuration processing area	source	316	Not affected	Inputs
Aux channel	Compressor processing area - side chain section	MENU	315	Not affected	Sidechains
Aux channel	Compressor processing area	source	315	Not affected	Sidechains
Aux channel	Insert/configuration processing area	dest	315	Busses	Not affected
Aux channel	Insert/configuration processing area - direct input section	source	315	Not affected	Dir. In
Aux channel	Insert/configuration processing area - insert section	dest	315	Ins. Sends	Not affected
Aux channel	Insert/configuration processing area - insert section	source	315	Not affected	Ins. Ret.
Matrix output channel	Compressor processing area - side chain section	MENU	317	Not affected	Sidechains
Matrix output channel	Compressor processing area	source	317	Not affected	Sidechains
Matrix output channel	Insert/configuration processing area	dest	317	Busses	Not affected

<i>Channel or signal type</i>	<i>Location on GUI screen area</i>	<i>Button legend</i>	<i>Page ref.</i>	<i>Opens the tab sheet in the ...</i>	
				<i>From section</i>	<i>To section</i>
Matrix output channel	Insert/configuration processing area - direct input section	source	317	Not affected	Dir. In
Matrix output channel	Insert/configuration processing area - insert section	dest	317	Ins. Sends	Not affected
Matrix output channel	Insert/configuration processing area - insert section	source	317	Not affected	Ins. Ret.
Master output channel	Compressor processing area - side chain section	MENU	318	Not affected	Sidechains
Master output channel	Compressor processing area	source	318	Not affected	Sidechains
Master output channel	Insert/configuration processing area	dest	318	Busses	Not affected
Master output channel	Insert/configuration processing area - direct input section	source	318	Not affected	Dir. In
Master output channel	Insert/configuration processing area - insert section	dest	318	Ins. Sends	Not affected
Master output channel	Insert/configuration processing area - insert section	source	318	Not affected	Ins. Ret.
Monitors	Monitors screen - talk input section	source	144	Not affected	Mon.
Monitors	Monitors screen - external talk output section	dest	144	Mon.	Not affected
Monitors	Monitors screen - talkback input section	source	144	Not affected	Mon.
Monitors	Monitors screen - pfl direct input section	source	144	Not affected	Mon.
Monitors	Monitors screen - afl direct input left section	source	144	Not affected	Mon.
Monitors	Monitors screen - afl direct input right section	source	144	Not affected	Mon.
Monitors	Monitors screen - external input L section	source	144	Not affected	Mon.
Monitors	Monitors screen - external input R section	source	144	Not affected	Mon.
Monitors	Monitors screen - monitor A output L section	dest	144	Mon.	Not affected

<i>Channel or signal type</i>	<i>Location on GUI screen area</i>	<i>Button legend</i>	<i>Page ref.</i>	<i>Opens the tab sheet in the ...</i>	
				<i>From section</i>	<i>To section</i>
Monitors	Monitors screen - monitor A output R section	dest	144	Mon.	Not affected
Monitors	Monitors screen - monitor B output L section	dest	144	Mon.	Not affected
Monitors	Monitors screen - monitor B output R section	dest	144	Mon.	Not affected
Monitors	Monitors screen - monitor centre output section	dest	144	Mon.	Not affected
Monitors	Monitors screen - monitor LFE output section	dest	144	Mon.	Not affected

Appendix K: Parameters Affected By Scope

This appendix shows the parameters affected by scope.

Note: The parameter areas for the scopes (recall and store) and the safes are basically the same. However, the way they are presented in this manual in their respective appendices is different. This may provide you with a useful alternative when referring to this material, should you prefer one more than the other (see Appendix M "Parameters Protected By Safes" on page 469).

Introduction

This appendix shows you which parameters are or are not scoped when you select the parameter sections in the channels, buses, groups, effects and GEOs on the **Recall Scope** and **Store Scope** screens.

There is a section for each area (channel, bus, group, effect and GEO) on each scope screen, and these sections are then subdivided according to the processing areas in the fast/channel strips on the control surface and GUI.

The following diagram shows typical examples of PRO Series **Recall Scope** and **Store Scope** screens (with no parameter sections selected), and the table to the right shows what the symbols in each section mean. In the table the orange letters in the **Ref.** column are used in the tables throughout this appendix to help you quickly identify the parameter sections.

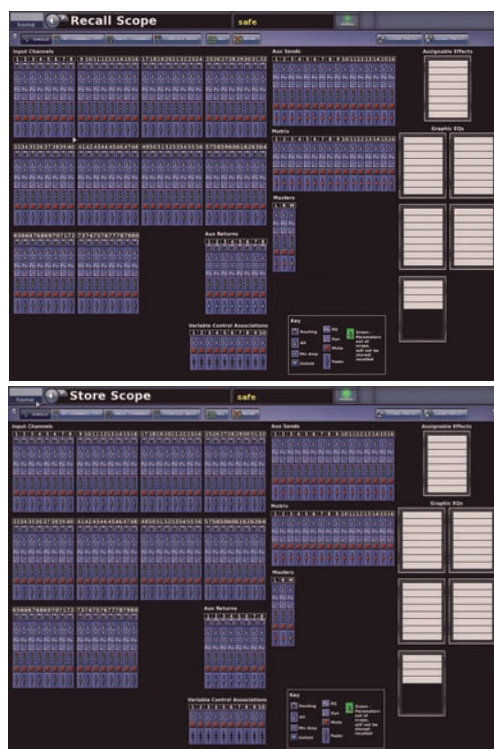

Ref.	Parameter section	Symbol
A	Routing	
B	All	
C	Mic Amp	
D	EQ	
E	Dyn	
F	Busses	
G	Mute	
H	Fader	

In the tables in this appendix: **Yes** = scoped, **No** = not scoped and N/A = not applicable.

Note: Some of the GUI displays in this appendix may look slightly different to the ones on the PRO Series Control Centre you are using, as they may be taken from a different type of PRO Series Live Audio System. For example, the PRO3 doesn't have a **Matrix 9 - 16** section in the GUI channel strip and only has a maximum of six effects. However, all of the parameters affected by scope still apply.

Overview

The following table shows the page references (in this chapter) of the control areas for the channels, GEOs, effects and VCA groups.

Table 26: Reference to scope areas

Control area	Input Channels	Aux Returns (Returns)	Aux Sends (Auxes)	Matrix (Matrices)	Masters	Graphic EQs	Assignable Effects	Variable Control Associations (VCAs)
Patching	Page 423	Page 433	Page 439	Page 447	Page 453	Page 460	Page 462	N/A
Configura-tion	Page 424	Page 434	Page 440	Page 448	Page 454	N/A	N/A	N/A
Dynamics	Page 426	N/A	Page 441	Page 449	Page 455	N/A	N/A	N/A
Insert	Page 427	N/A	Page 442	Page 450	Page 456	N/A	N/A	N/A
EQ	Page 428	N/A	Page 443	Page 451	Page 457	N/A	N/A	N/A
Aux send	Page 429	N/A	N/A	N/A	N/A	N/A	N/A	N/A
Matrix send	Page 430	Page 436	Page 444	N/A	Page 458	N/A	N/A	N/A
Fader	Page 431	Page 437	Page 445	Page 452	Page 459	N/A	N/A	N/A
GEO	N/A	N/A	N/A	N/A	N/A	Page 461	N/A	N/A
Effects	N/A	N/A	N/A	N/A	N/A	N/A	Page 463	N/A
Groups	N/A	N/A	N/A	N/A	N/A	N/A	N/A	Page 464

Inputs

Each scope screen has an **Input Channels** section that contains the requisite number of input channels for its particular PRO Series Live Audio System.

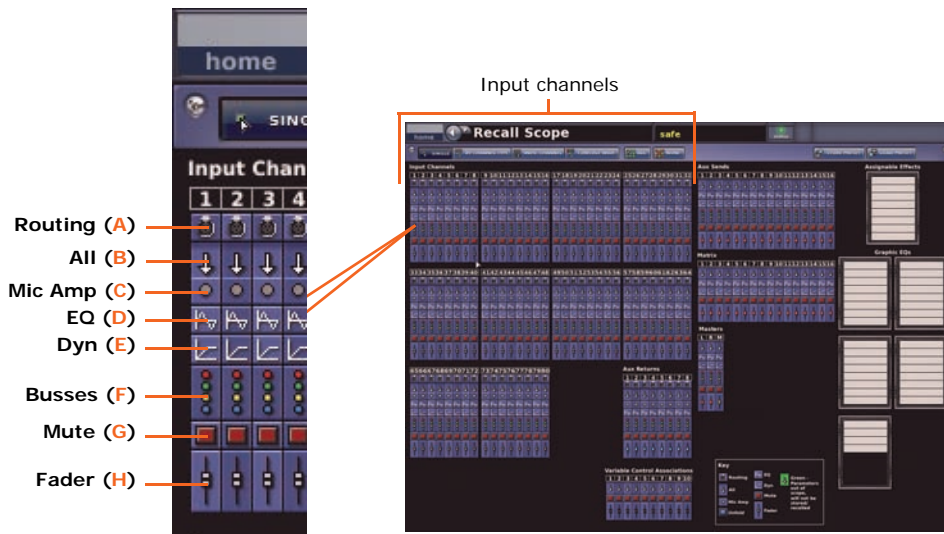

Parameter sections per input channel. The number of input channels are PRO Series-type dependent. This example is taken from a PRO9.

Patching

The following diagram details the scoped patching parameters of the input channels.

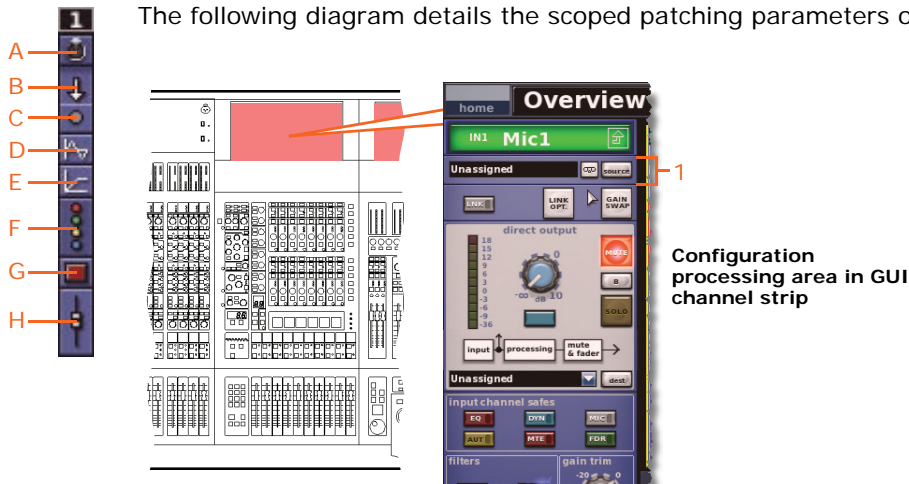

		A	B	C	D	E	F	G	H
Item	Parameter								
1	Input patching source	Yes*	Yes*	No	N/A	N/A	N/A	N/A	N/A







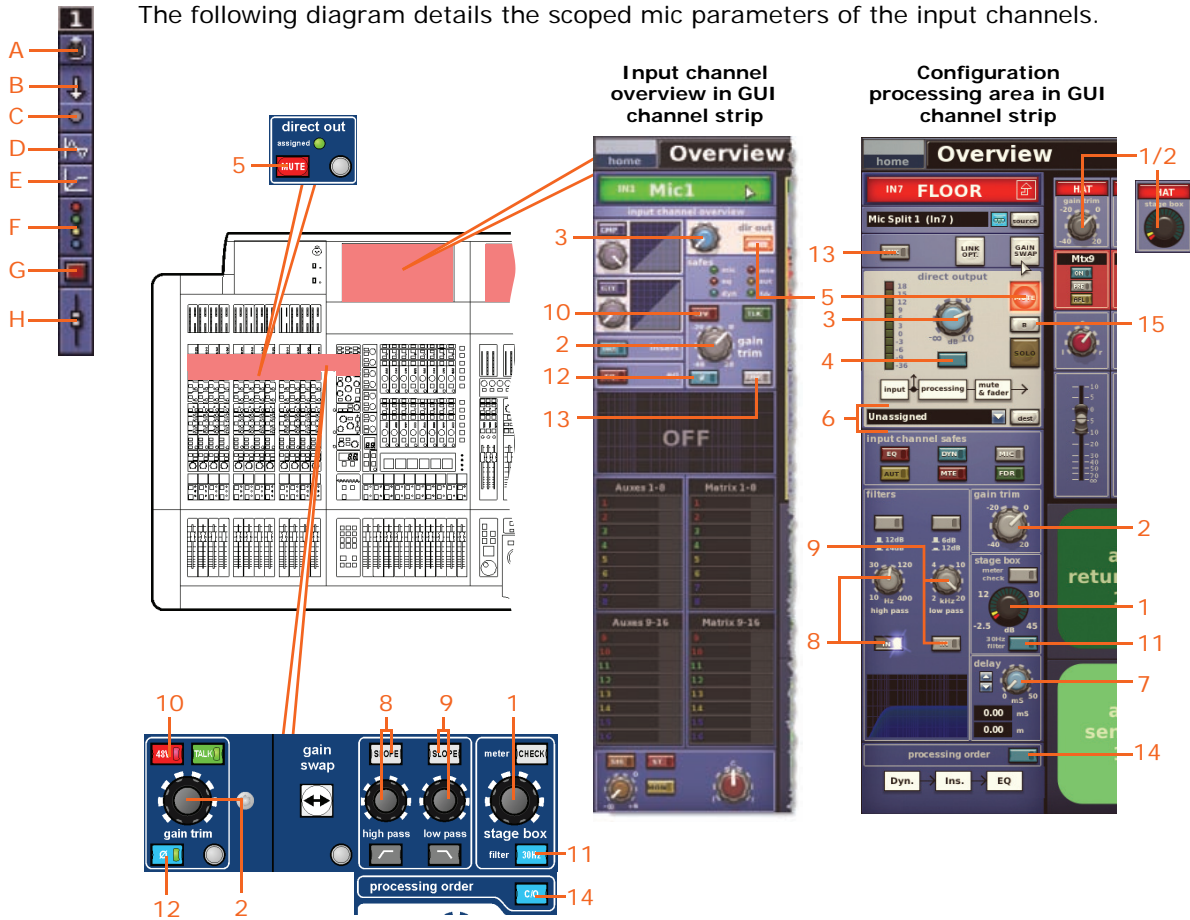

* Includes tape return and primary input sources.

Configuration

The following diagram details the scoped mic parameters of the input channels.



Item	Parameter	A	B	C	D	E	F	G	H
1	Mic gain*	N/A	Yes	Yes	N/A	N/A	N/A	N/A	N/A
2	Digital trim*	N/A	Yes	Yes	N/A	N/A	N/A	N/A	N/A
3	Direct output level	N/A	Yes	Yes	N/A	N/A	N/A	N/A	N/A
4	Direct output tap-off point	N/A	Yes	Yes	N/A	N/A	N/A	N/A	N/A
5	Direct output mute	N/A	Yes	No	N/A	N/A	N/A	Yes	N/A
6	Direct output patch destination	N/A	No	No	N/A	N/A	N/A	N/A	N/A
7	Input delay	N/A	Yes	Yes	N/A	N/A	N/A	N/A	N/A
8	Hi pass filter: slope in/out and rotary control	N/A	Yes	No	Yes	N/A	N/A	N/A	N/A
9	Low pass filter: slope in/out and rotary control	N/A	Yes	No	Yes	N/A	N/A	N/A	N/A
10	48V	N/A	Yes	Yes	N/A	N/A	N/A	N/A	N/A
11	30Hz filter	N/A	Yes	Yes	N/A	N/A	N/A	N/A	N/A
12	Input phase	N/A	Yes	Yes	N/A	N/A	N/A	N/A	N/A

		A	B	C	D	E	F	G	H
<i>Item</i>	<i>Parameter</i>								
13	Link	N/A	No	No	No	No	No	No	No
14	Processing order	N/A	Yes	N/A	Yes	N/A	N/A	N/A	N/A
15	Solo B assignment	N/A	No	No	No	No	No	No	No

* Depends on swap status.

Dynamics

The following diagram details the scoped compressor and gate parameters of the input channels. Although it only shows the corrective compressor, it also applies to the adaptive, creative and vintage compressors.

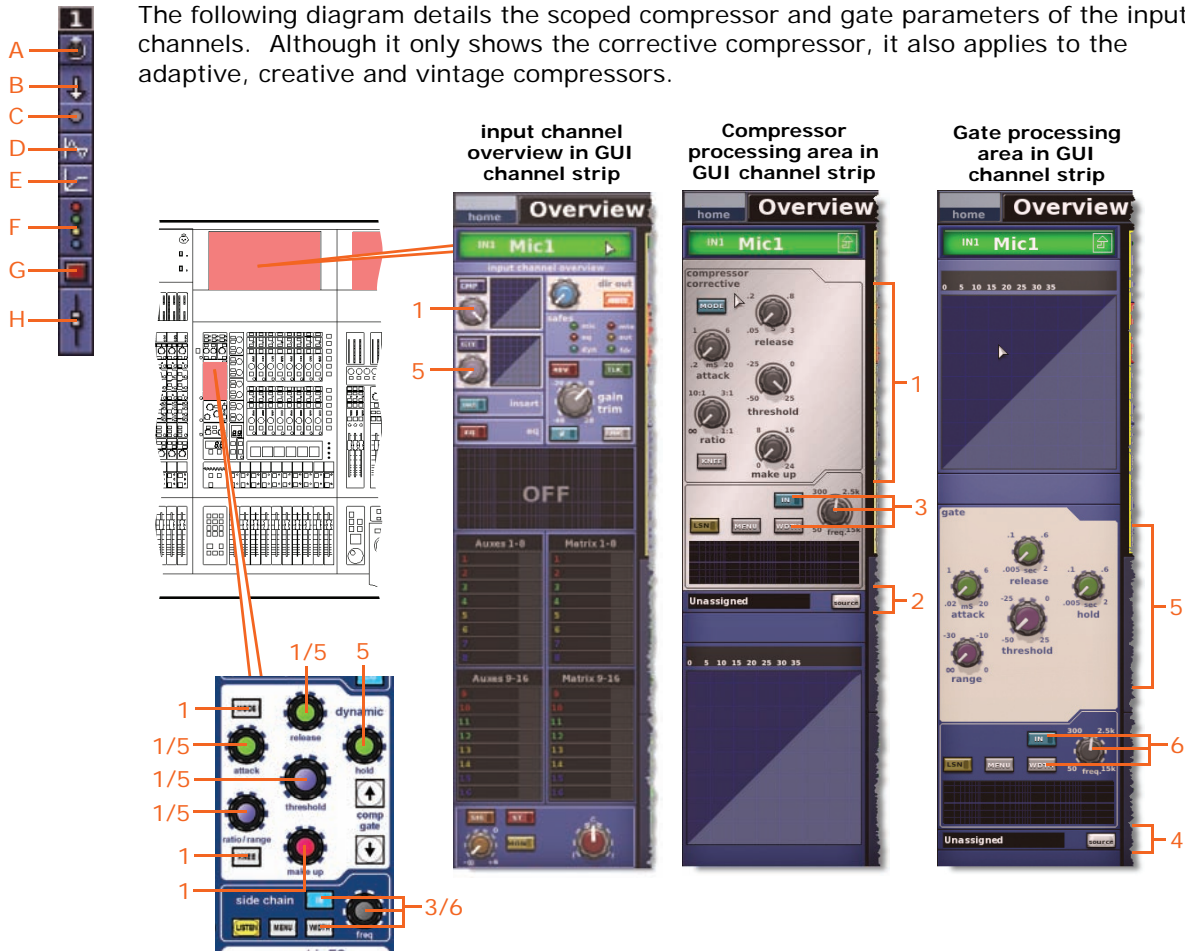

Item	Parameter	A			B		C		D		E		F		G		H	
		Icon	Icon	Icon	Icon	Icon	Icon	Icon	Icon	Icon	Icon	Icon	Icon	Icon	Icon	Icon	Icon	Icon
1	Compressor: attack , release , threshold , ratio/range /[ratio], make up , KNEE , MODE	N/A	Yes	N/A	N/A	N/A	N/A	N/A	Yes	N/A	N/A	N/A	N/A	N/A	N/A	N/A	N/A	N/A
2	Compressor sidechain source	No	N/A	N/A	N/A	N/A	N/A	N/A	N/A	N/A	N/A	N/A	N/A	N/A	N/A	N/A	N/A	N/A
3	Compressor sidechain: IN , freq , and WIDTH	N/A	Yes	N/A	N/A	N/A	N/A	Yes	N/A	N/A	N/A	N/A	N/A	N/A	N/A	N/A	N/A	N/A
4	Gate key in source	No	N/A	N/A	N/A	N/A	N/A	N/A	N/A	N/A	N/A	N/A	N/A	N/A	N/A	N/A	N/A	N/A
5	Gate: attack , release , hold , threshold , ratio/range /[range]	N/A	Yes	N/A	N/A	N/A	N/A	Yes	N/A	N/A	N/A	N/A	N/A	N/A	N/A	N/A	N/A	N/A
6	Gate sidechain: IN , freq , and WIDTH	N/A	Yes	N/A	N/A	N/A	N/A	Yes	N/A	N/A	N/A	N/A	N/A	N/A	N/A	N/A	N/A	N/A

Insert

The following diagram details the scoped insert parameters of the input channels, and shows the insert processing area in the GUI channel strip.

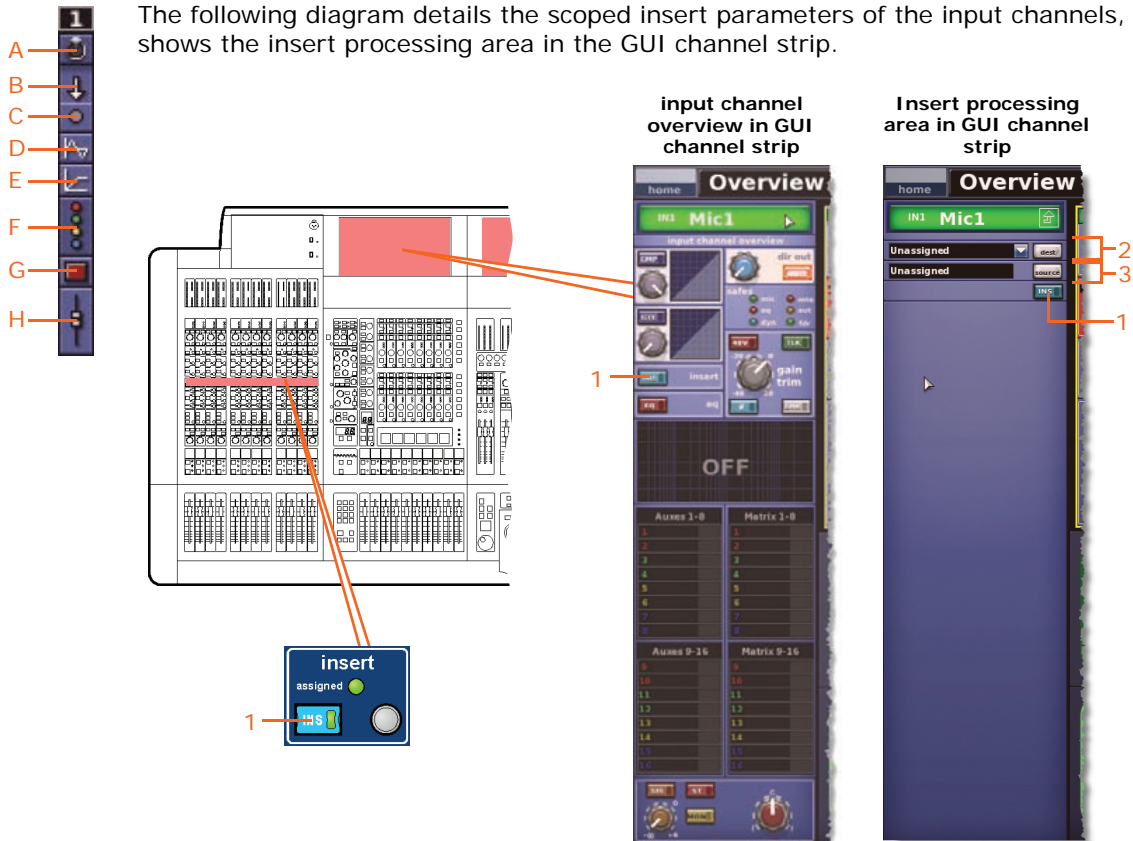

		A	B	C	D	E	F	G	H
Item	Parameter								
1	In/out	Yes	Yes	N/A	N/A	N/A	N/A	N/A	N/A
2	Insert send destination	N/A	No	N/A	N/A	N/A	N/A	N/A	N/A
3	Insert return source	N/A	No	N/A	N/A	N/A	N/A	N/A	N/A

EQ

The following diagram details the scoped parametric EQ parameters of the input channels.

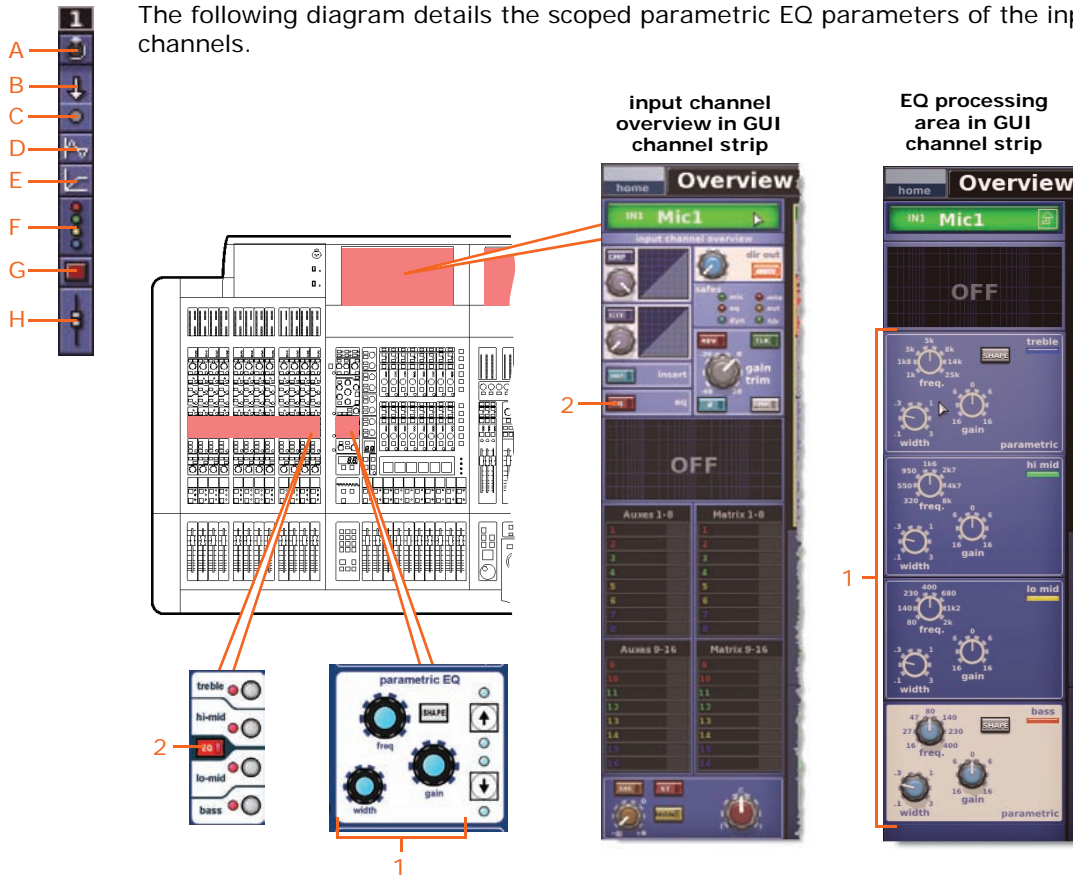

		A	B	C	D	E	F	G	H
Item	Parameter								
1	All filters: freq, gain, width, SHAPE	N/A	Yes	N/A	Yes	N/A	N/A	N/A	N/A
2	EQ in/out	N/A	Yes	N/A	Yes	N/A	N/A	N/A	N/A

Aux send

The following diagram details the scoped aux send parameters of the input channels. Although it only shows aux buses 1 to 8, it also applies to aux buses 9 to 16.

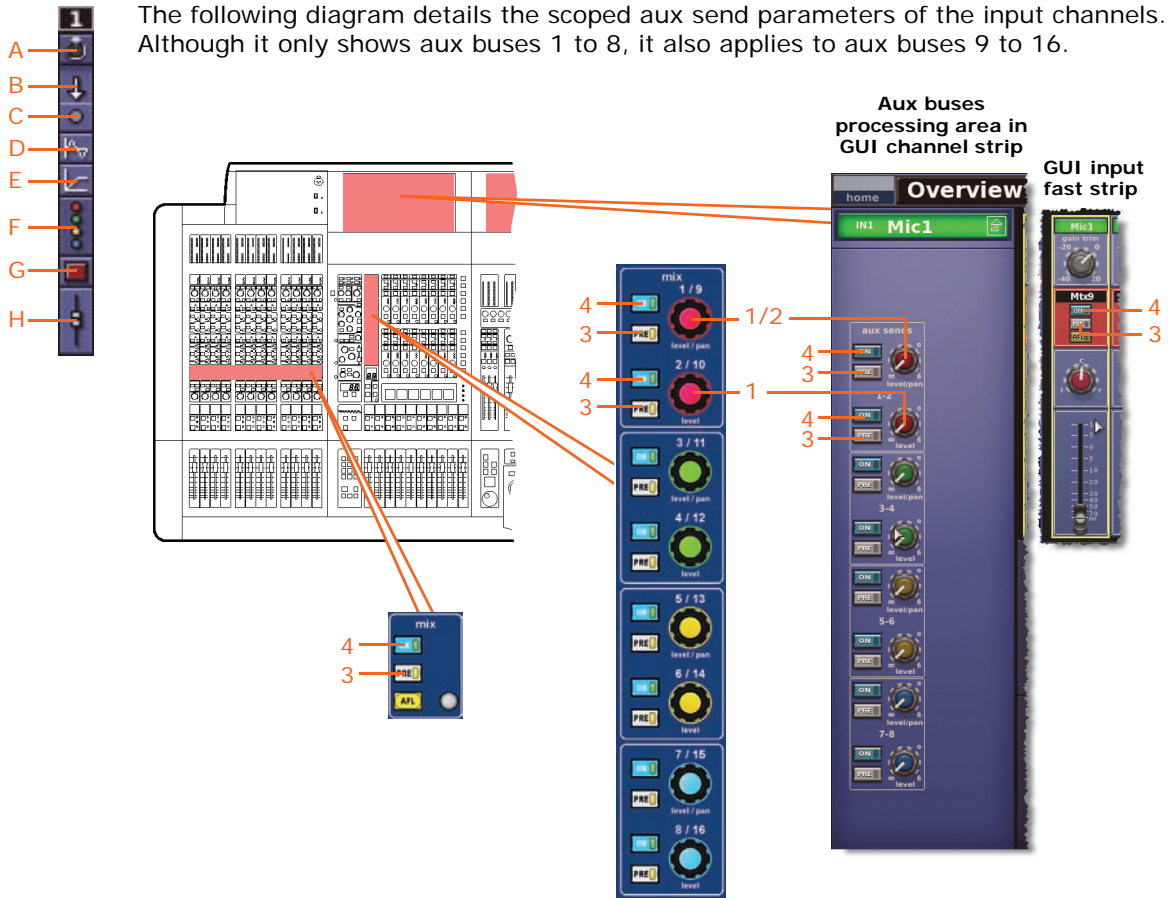

		A	B	C	D	E	F	G	H
Item	Parameter								
1	Send level	N/A	Yes	N/A	N/A	N/A	Yes	N/A	N/A
2	Send pan	N/A	Yes	N/A	N/A	N/A	Yes	N/A	N/A
3	Send pre-fader on/off	N/A	Yes	N/A	N/A	N/A	Yes	N/A	N/A
4	Send on/off	N/A	Yes	N/A	N/A	N/A	Yes	N/A	N/A

You can scope individual bus sends. In column **B (All)**, all sends are affected, and in column **F (Busses)**, individual sends can be scoped.

Matrix send

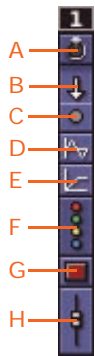

The following diagram details the scoped matrix send parameters in the input channels. Although it only shows matrix buses 1 to 8, it also applies to matrix buses 9 to 16 (PRO6 and PRO9 only).

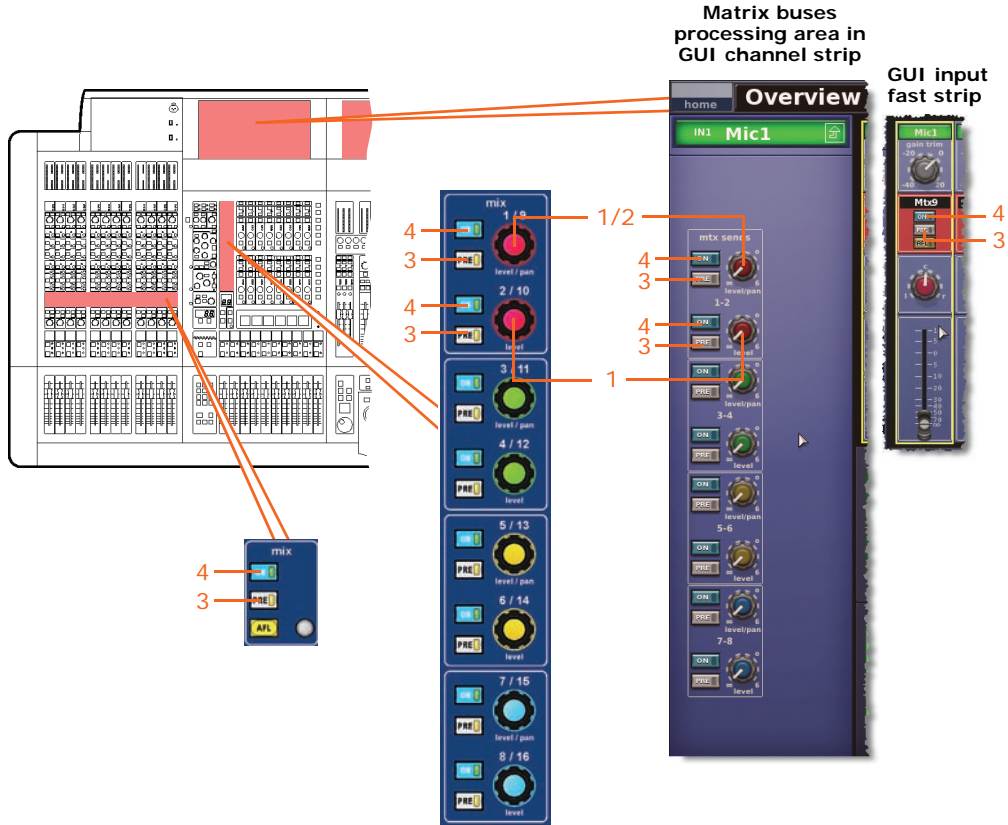

		A	B	C	E	D	F	G	H
Item	Parameter								
1	Send level*	N/A	Yes	N/A	N/A	N/A	Yes	N/A	N/A
2	Send pan*	N/A	Yes	N/A	N/A	N/A	Yes	N/A	N/A
3	Send pre-fader on/off	N/A	Yes	N/A	N/A	N/A	Yes	N/A	N/A
4	Send on/off	N/A	Yes	N/A	N/A	N/A	Yes	N/A	N/A







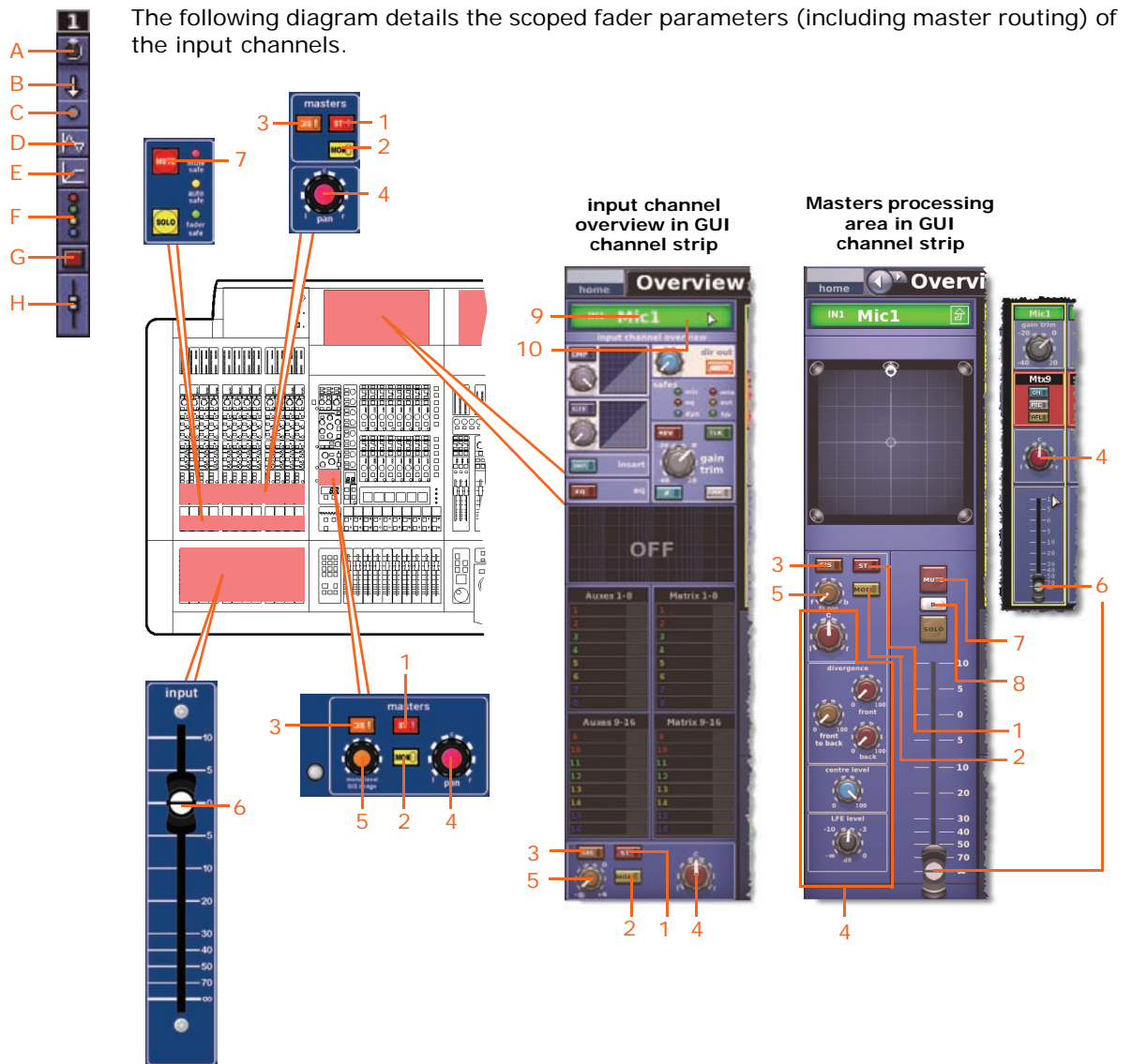

* Bus send levels/panning can also be adjusted via the **input channel overview** (GUI channel strip) by using drag in the aux and matrix panels.

You can scope individual bus sends. In column **B (All)**, all sends are affected, and in column **F (Busses)**, individual sends can be scoped.

Fader



		A	B	C	D	E	F	G	H
Item	Parameter								
1	Stereo routing	N/A	Yes	N/A	N/A	N/A	N/A	N/A	Yes
2	Mono routing	N/A	Yes	N/A	N/A	N/A	N/A	N/A	Yes
3	SIS select (required for surround panning)	N/A	Yes	N/A	N/A	N/A	N/A	N/A	Yes
4	Pan (includes all surround sound parameters)	N/A	Yes	N/A	N/A	N/A	N/A	N/A	Yes
5	Mono level/SIS pan	N/A	Yes	N/A	N/A	N/A	N/A	N/A	Yes
6	Fader position	N/A	Yes	N/A	N/A	N/A	N/A	N/A	Yes
7	Channel mute	N/A	Yes	N/A	N/A	N/A	N/A	Yes	No
8	Solo B assignment	N/A	No	N/A	N/A	N/A	N/A	N/A	No

<i>Item</i>	<i>Parameter</i>	A	B	C	D	E	F	G	H
									
9	Channel name	N/A	Yes	N/A	N/A	N/A	N/A	N/A	No
10	Channel colour	N/A	Yes	N/A	N/A	N/A	N/A	N/A	No

Returns (Aux Returns)

Each scope screen has 8 returns in the **Aux Returns** section.

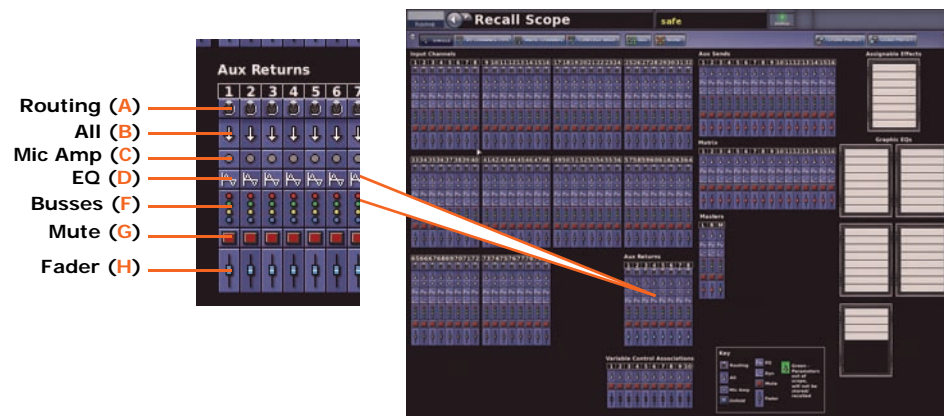

Parameter sections per return channel. There are eight returns per PRO Series Control Centre. This example is taken from a PRO9.

Patching

The following diagram details the scoped patching parameters of the return channels.

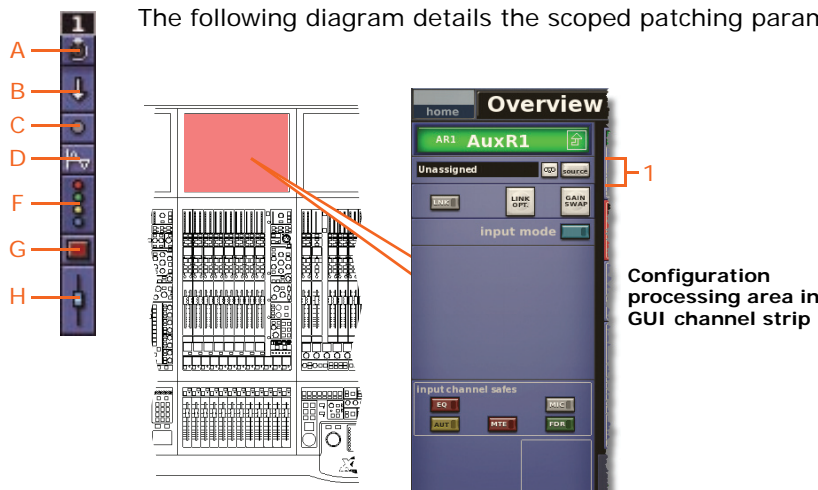

		A	B	C	D	E	F	G	H
Item	Parameter								
1	Input patching source	N/A	Yes ¹	N/A	N/A	N/A	N/A	N/A	N/A

1. Includes tape return and primary input sources.

Configuration

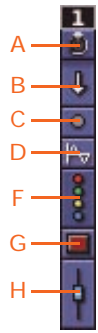

The following diagram details the scoped areas of the mic section in the return channels.

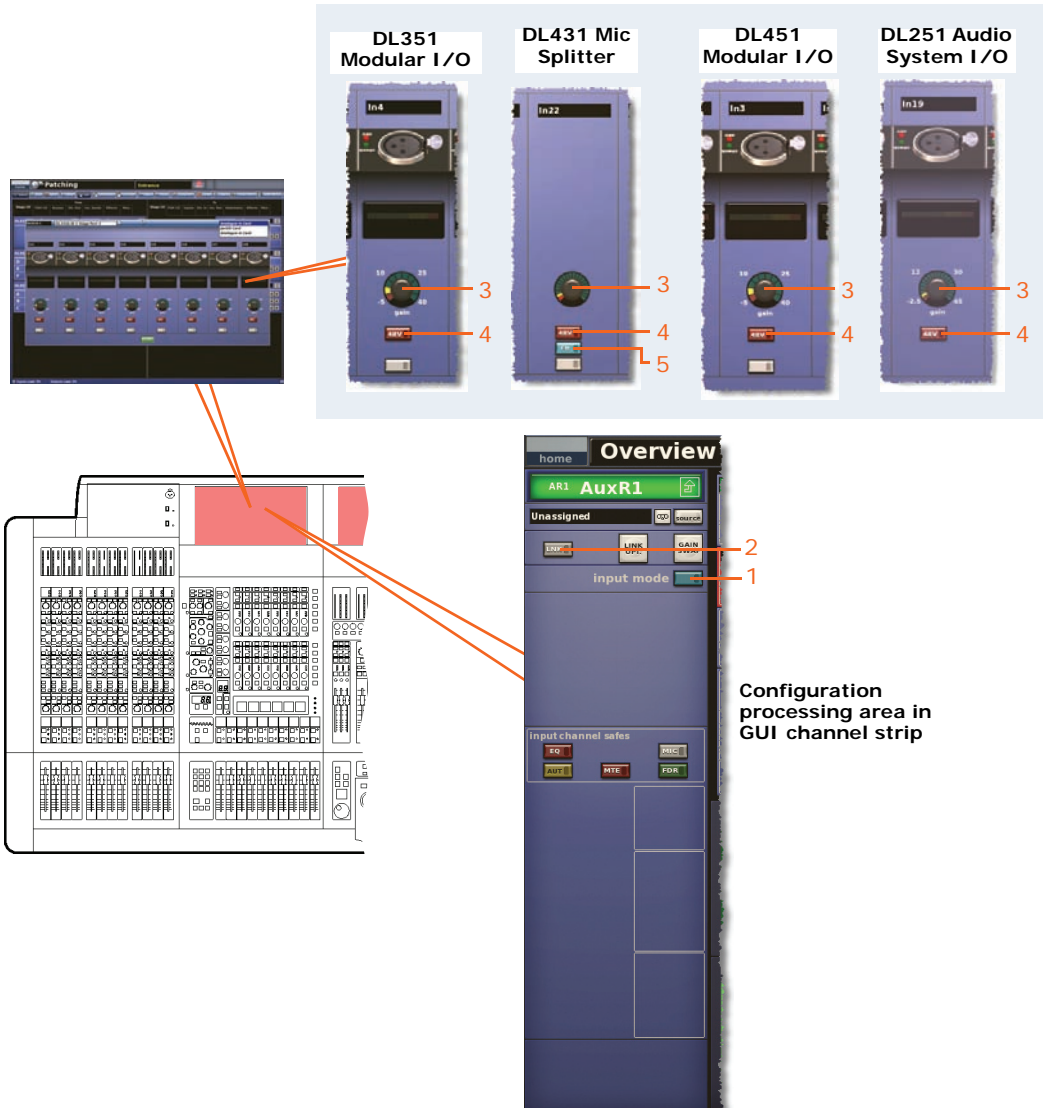

		A	B	C	D	E	F	G	H
Item	Parameter								
1	Input zone	N/A	Yes	Yes	N/A	N/A	N/A	N/A	N/A
2	Link	N/A	No	No	No	No	No	No	No
3	Gain of remote amplifier	N/A	Yes	Yes	N/A	N/A	N/A	N/A	N/A
4	48V phantom gain	N/A	Yes	Yes	N/A	N/A	N/A	N/A	N/A
5	30Hz filter	N/A	Yes	Yes	N/A	N/A	N/A	N/A	N/A

Dynamics

Not applicable.

Insert

Not applicable.

EQ

Not applicable.

Aux send

Not applicable.

Matrix send

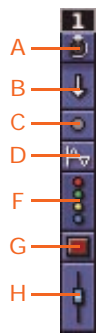

The following diagram details the scoped parameters of the return channels. Although it only shows matrix buses 1 to 8, it also applies to matrix buses 9 to 16 (PRO6 and PRO9 only).

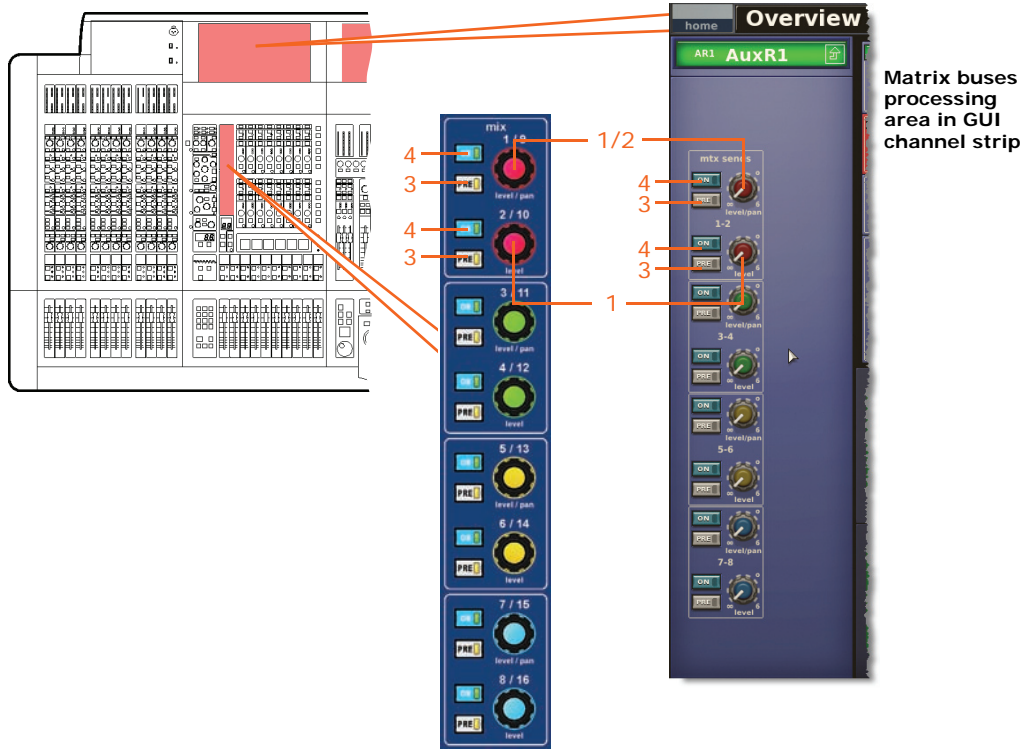

Item	Parameter	A	B	C	D	E	F	G	H
1	Send level	N/A	Yes	N/A	N/A	N/A	Yes	N/A	N/A
2	Send pan	N/A	Yes	N/A	N/A	N/A	Yes	N/A	N/A
3	Send pre-fader on/off	N/A	Yes	N/A	N/A	N/A	Yes	N/A	N/A
4	Send on/off	N/A	Yes	N/A	N/A	N/A	Yes	N/A	N/A

Fader

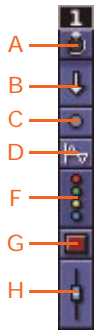

The following diagram details the scoped fader (including master routing) parameters of the return channels.



input channel overview in GUI channel strip

Masters processing area in GUI channel strip

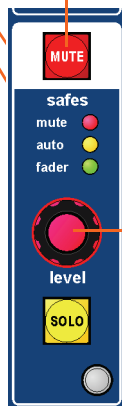
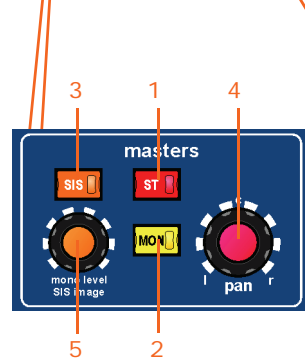
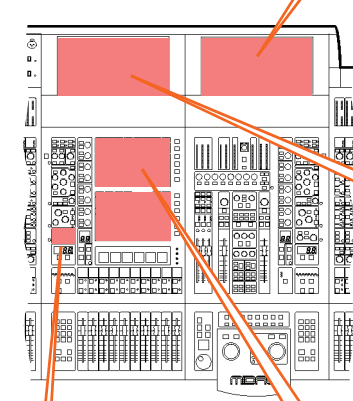

		A	B	C	D	E	F	G	H
Item	Parameter								
1	Stereo routing	N/A	Yes	N/A	N/A	N/A	N/A	N/A	Yes
2	Mono routing	N/A	Yes	N/A	N/A	N/A	N/A	N/A	Yes
3	SIS select (required for surround panning)	N/A	Yes	N/A	N/A	N/A	N/A	N/A	Yes
4	Pan (includes all surround sound parameters)	N/A	Yes	N/A	N/A	N/A	N/A	N/A	Yes

Item	Parameter	A	B	C	D	E	F	G	H
5	Mono level/SIS pan	N/A	Yes	N/A	N/A	N/A	N/A	N/A	Yes
6	Fader position	N/A	Yes	N/A	N/A	N/A	N/A	N/A	Yes
7	Channel mute	N/A	Yes	N/A	N/A	N/A	N/A	Yes	N/A
8	Solo B assignment	N/A	No	N/A	N/A	N/A	N/A	N/A	N/A
9	Channel name	N/A	Yes	N/A	N/A	N/A	N/A	N/A	N/A
10	Channel colour	N/A	Yes	N/A	N/A	N/A	N/A	N/A	N/A

Auxes (Aux Sends)

Each scope screen has 16 auxes in the **Aux Sends** section.

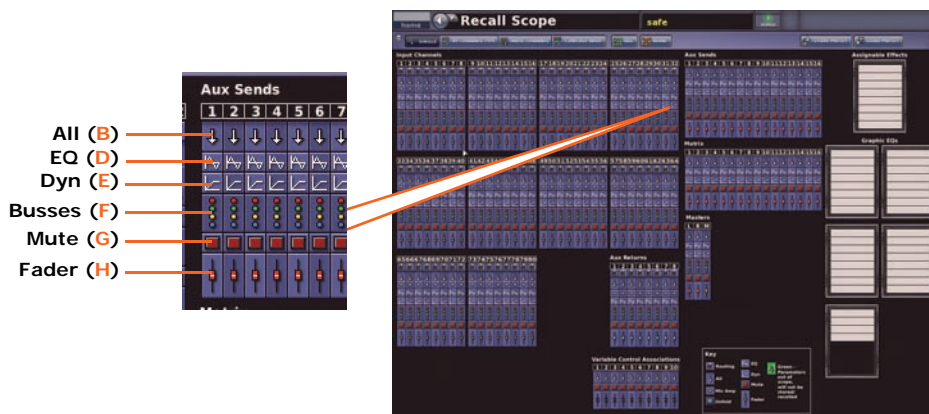

Parameter sections per aux channel. There are 16 auxes per PRO Series Control Centre. This example is taken from a PRO9.

Patching

The following diagram details the scoped patching parameters of the aux channels.

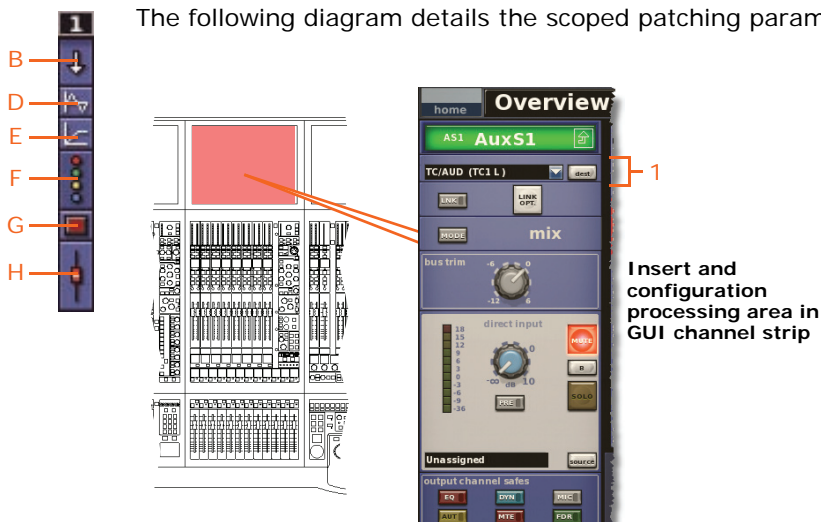

Item	Parameter	A	B	C	D	E	F	G	H
1	Output patching	N/A	No	N/A	N/A	N/A	N/A	N/A	N/A

Configuration

The following diagram details the scoped configuration and direct input parameters of the aux channels.

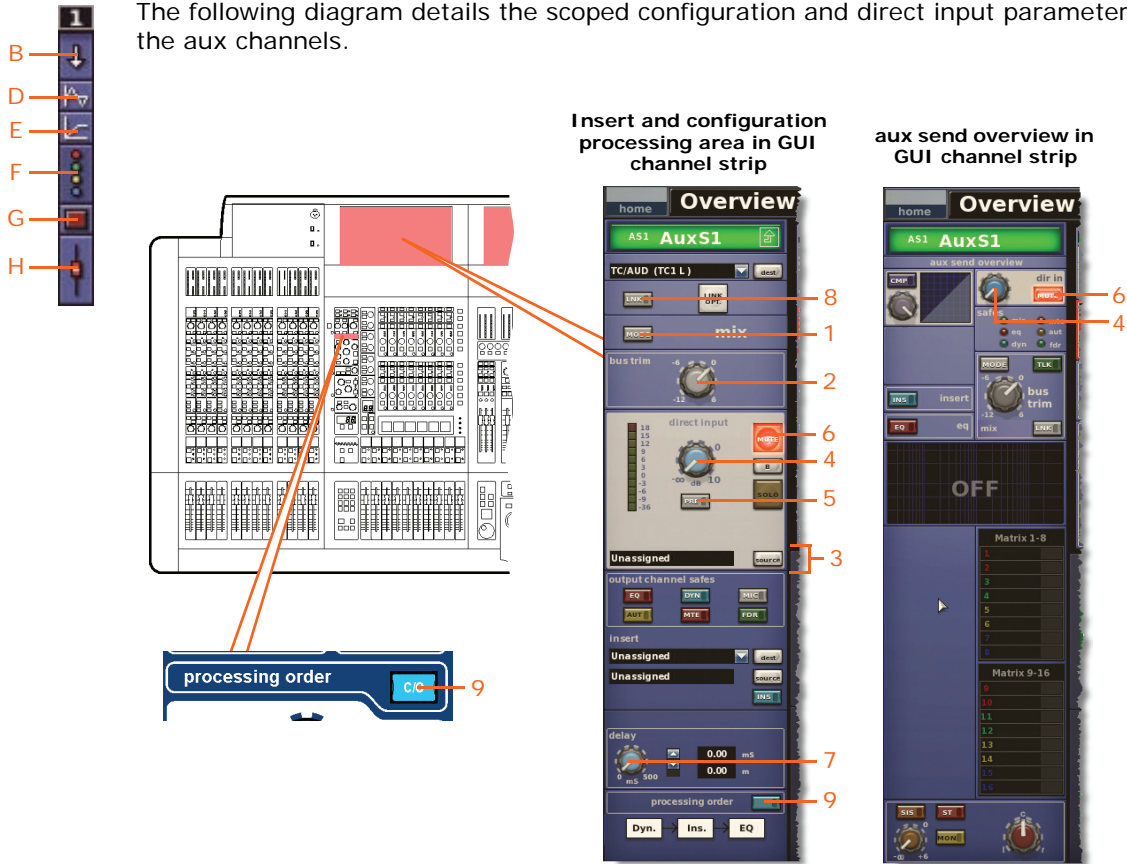

Item	Parameter	A	B	C	D	E	F	G	H
1	Bus mode	N/A	Yes	N/A	N/A	N/A	N/A	N/A	Yes
2	Bus trim	N/A	Yes	N/A	N/A	N/A	N/A	N/A	Yes
3	Direct input source	N/A	Yes ¹	N/A	N/A	N/A	N/A	N/A	N/A
4	Direct input level	N/A	Yes	N/A	N/A	N/A	N/A	N/A	N/A
5	Direct input pre-/post-	N/A	Yes	N/A	N/A	N/A	N/A	N/A	N/A
6	Direct input mute	N/A	Yes	N/A	N/A	N/A	N/A	Yes	N/A
7	Delay	N/A	Yes	N/A	N/A	N/A	N/A	N/A	Yes
8	Link	N/A	No	N/A	No	No	No	No	No
9	Process order	N/A	Yes	N/A	Yes	N/A	N/A	N/A	N/A

1. Only when automate patching is on.

Dynamics

The following diagram details the scoped compressor parameters of the aux channels. Although only the corrective compressor is shown below, this is typically the same for the other compressor modes (adaptive, creative, vintage and shimmer).

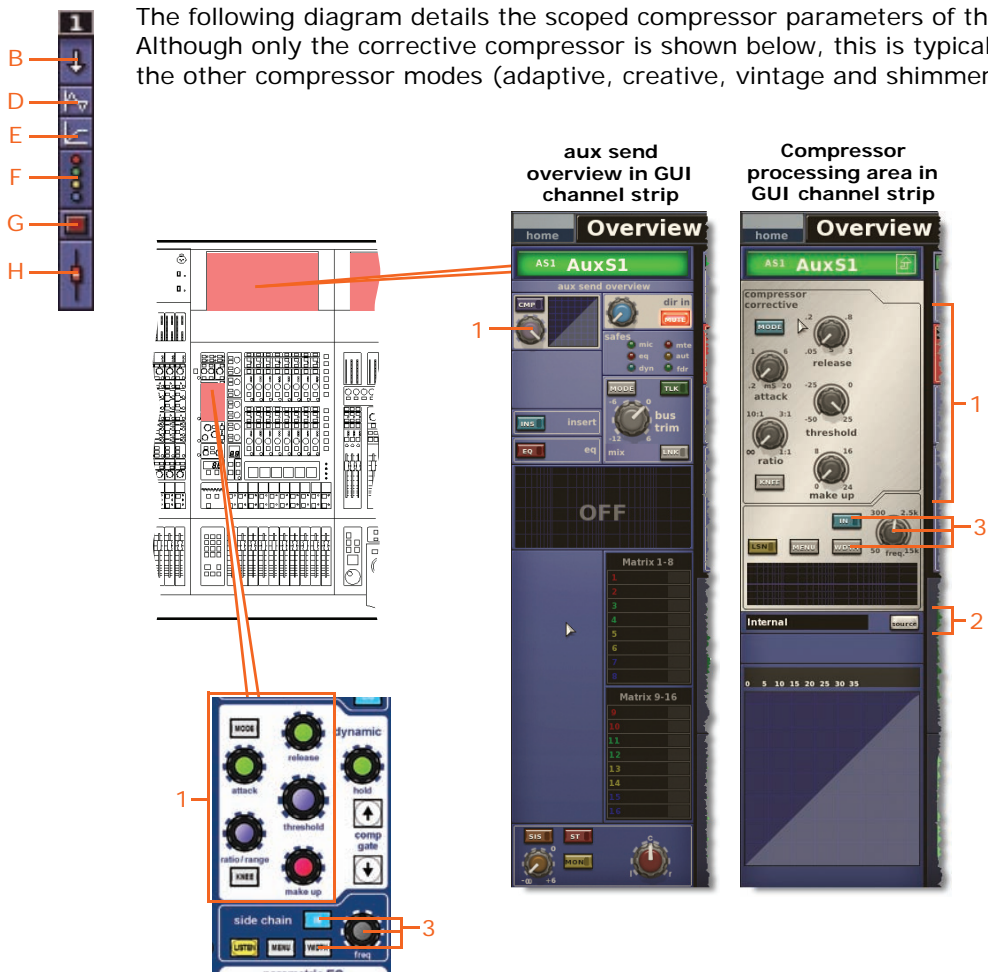

		A	B	C	D	E	F	G	H
Item	Parameter								
1	Compressor: attack, release, threshold, ratio/range/[ratio], make up, KNEE, MODE	N/A	Yes	N/A	N/A	Yes	N/A	N/A	N/A
2	Sidechain source	N/A	N/A	N/A	N/A	No	N/A	N/A	N/A
3	Compressor sidechain: IN, freq, and WIDTH	N/A	Yes	N/A	N/A	Yes	N/A	N/A	N/A

Insert

The following diagram details the scoped insert parameters of the aux channels.

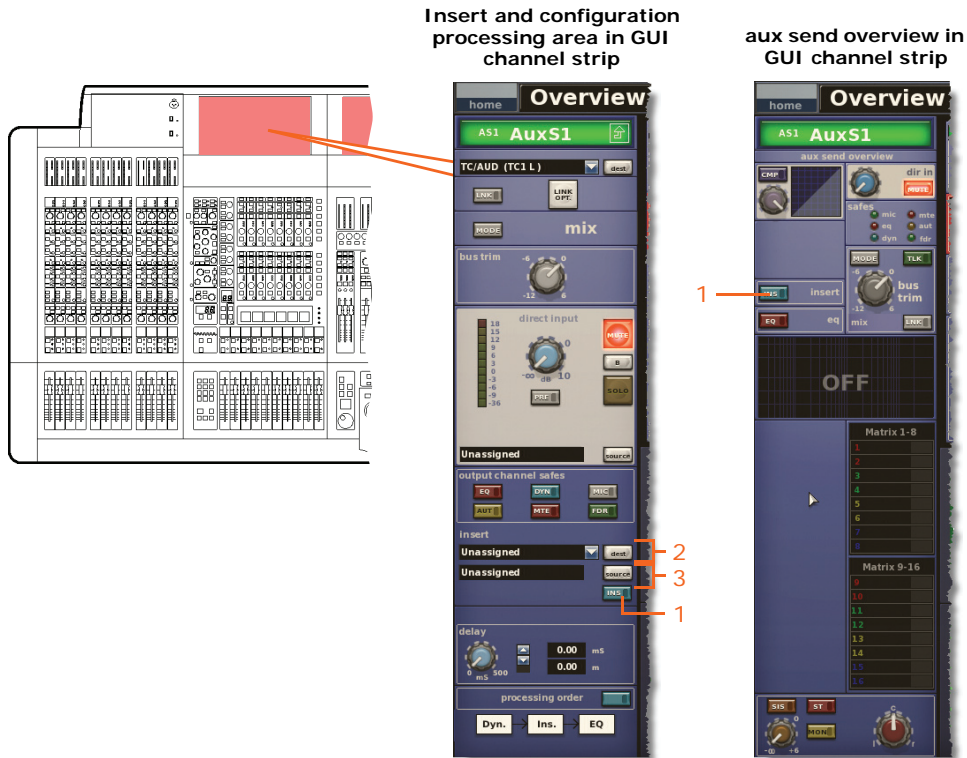
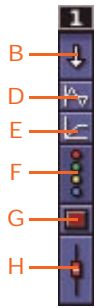

		A	B	C	D	E	F	G	H
Item	Parameter								
1	In/out	N/A	Yes	N/A	N/A	N/A	N/A	N/A	N/A
2	Insert send destination	N/A	No	N/A	N/A	N/A	N/A	N/A	N/A
3	Insert return source	N/A	No	N/A	N/A	N/A	N/A	N/A	N/A

EQ

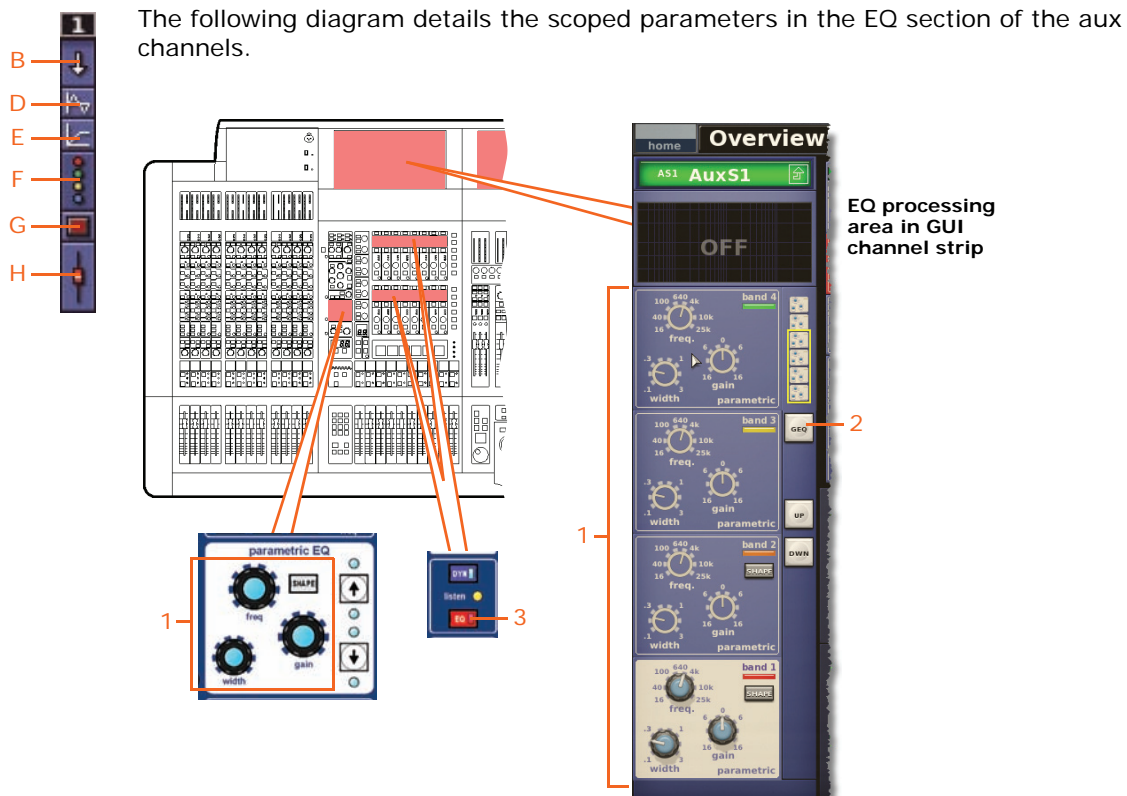

		A	B	C	D	E	F	G	H
Item	Parameter								
1	All PEQ filters (all six bands): freq, gain, width, SHAPE (as necessary)	N/A	Yes	N/A	Yes	N/A	N/A	N/A	N/A
2	Parametric/Graphic type	N/A	No	N/A	No	N/A	N/A	N/A	N/A
3	EQ in/out	N/A	Yes	N/A	Yes	N/A	N/A	N/A	N/A

Aux send

Not applicable.

Aux preset

Not applicable.

Matrix send

The following diagram details the scoped parameters in the aux channels. Although only matrices 1 to 8 are shown below, this also applies to all matrices.

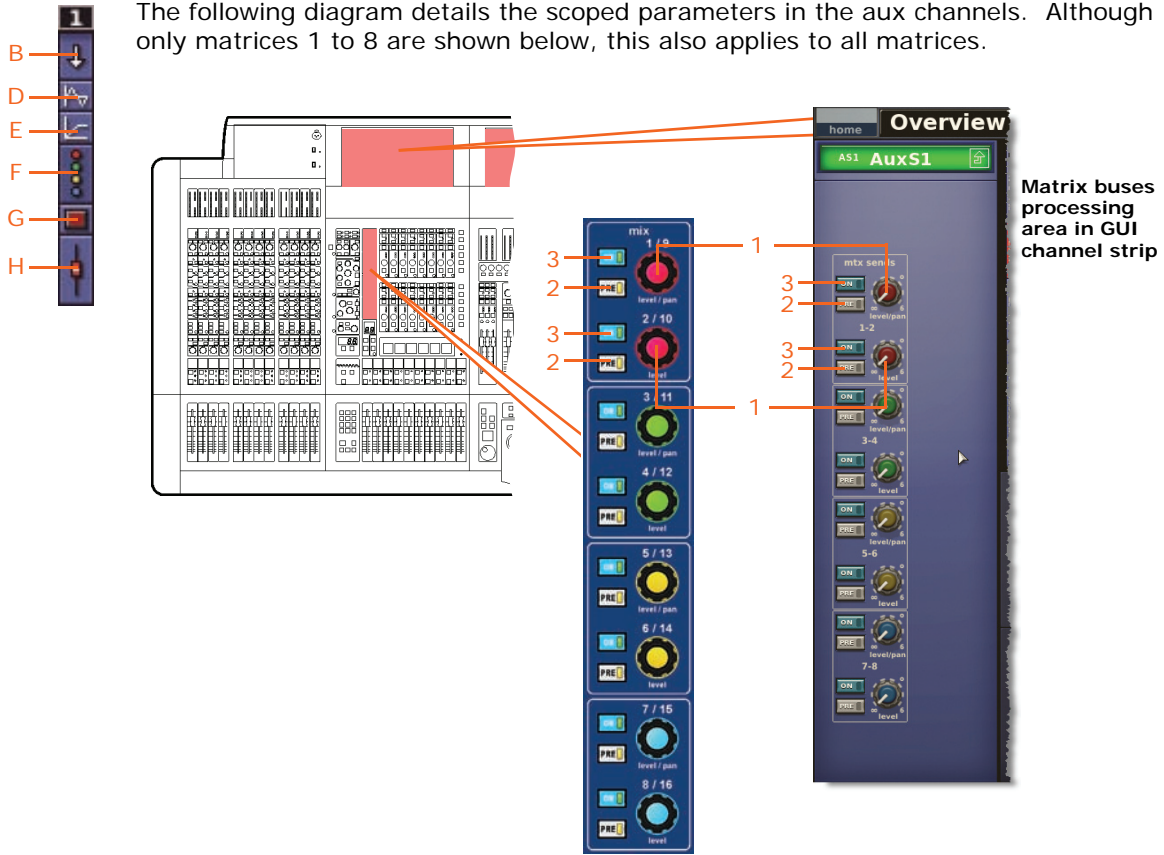

		A	B	C	D	E	F	G	H
Item	Parameter								
1	Send level	N/A	Yes	N/A	N/A	N/A	Yes	N/A	N/A
2	Send pre-fader on/off	N/A	Yes	N/A	N/A	N/A	Yes	N/A	N/A
3	Send on/off	N/A	Yes	N/A	N/A	N/A	Yes	N/A	N/A

You can scope individual bus sends. In column **B (All)**, all sends are affected, and in column **F (Busses)**, individual sends can be scoped.

Fader

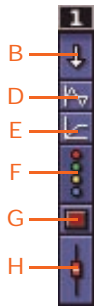

The following diagram details the scoped fader and master routing parameters of the aux channels.

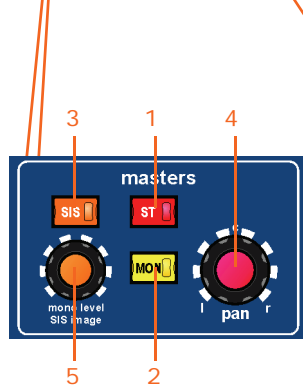



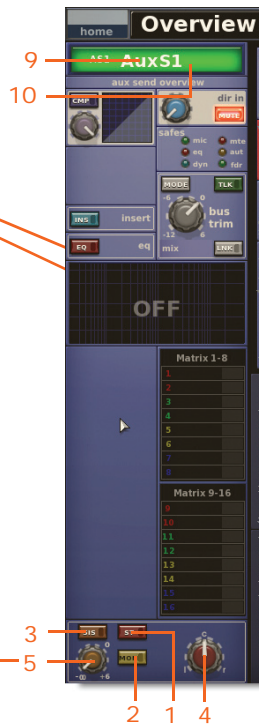





aux send overview in GUI channel strip



Masters processing area in GUI channel strip



Item	Parameter	A	B	C	D	E	F	G	H
1	Stereo routing	N/A	Yes	N/A	N/A	N/A	N/A	N/A	Yes
2	Mono routing	N/A	Yes	N/A	N/A	N/A	N/A	N/A	Yes
3	SIS select (required for surround panning)	N/A	Yes	N/A	N/A	N/A	N/A	N/A	Yes

<i>Item</i>	<i>Parameter</i>	A 	B 	C 	D 	E 	F 	G 	H 
4	Pan (includes ALL surround sound parameters)	N/A	Yes	N/A	N/A	N/A	N/A	N/A	Yes
5	Mono level/SIS pan	N/A	Yes	N/A	N/A	N/A	N/A	N/A	Yes
6	Fader position	N/A	Yes	N/A	N/A	N/A	N/A	N/A	Yes
7	Channel mute	N/A	Yes	N/A	N/A	N/A	N/A	Yes	No
8	Solo B assignment	N/A	No	N/A	N/A	N/A	N/A	N/A	No
9	Channel name	N/A	Yes	N/A	N/A	N/A	N/A	N/A	No
10	Channel colour	N/A	Yes	N/A	N/A	N/A	N/A	N/A	No

Matrices

Each scope screen has a **Matrix** section.

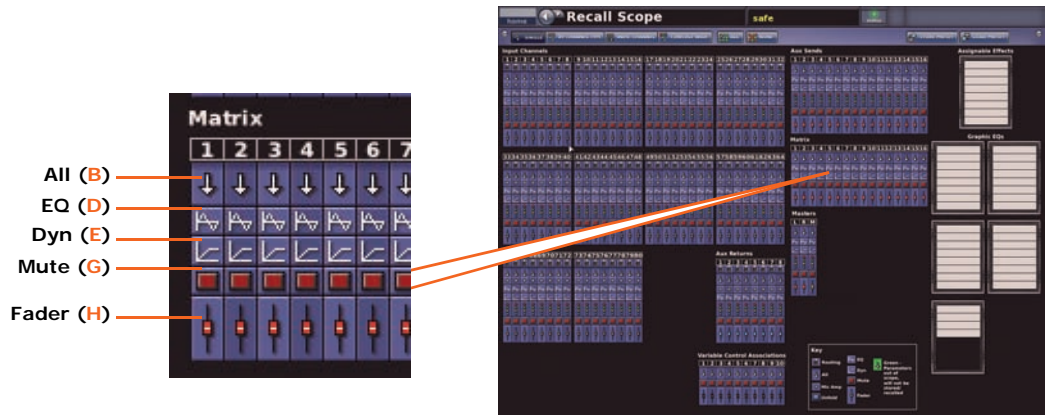

Parameter sections per matrix channel. There are 16 matrices per PRO6 and PRO9, and only eight on the PRO3. This example is taken from a PRO9.

Patching

The following diagram details the scoped patching parameters of the matrix channels.

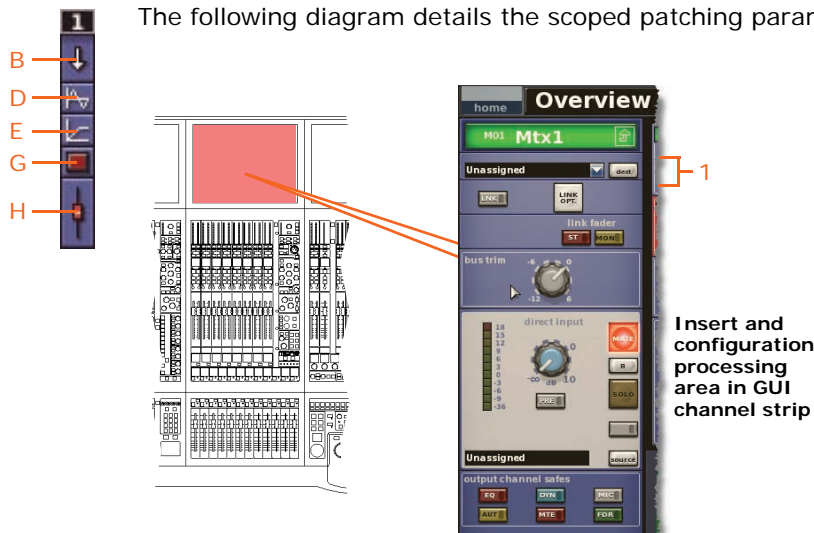

		A	B	C	D	E	F	G	H
Item	Parameter								
1	Output patching	N/A	No	N/A	N/A	N/A	N/A	N/A	N/A

Configuration

The following diagram details the scoped parameters of the configuration and direct input sections of the matrices channels.

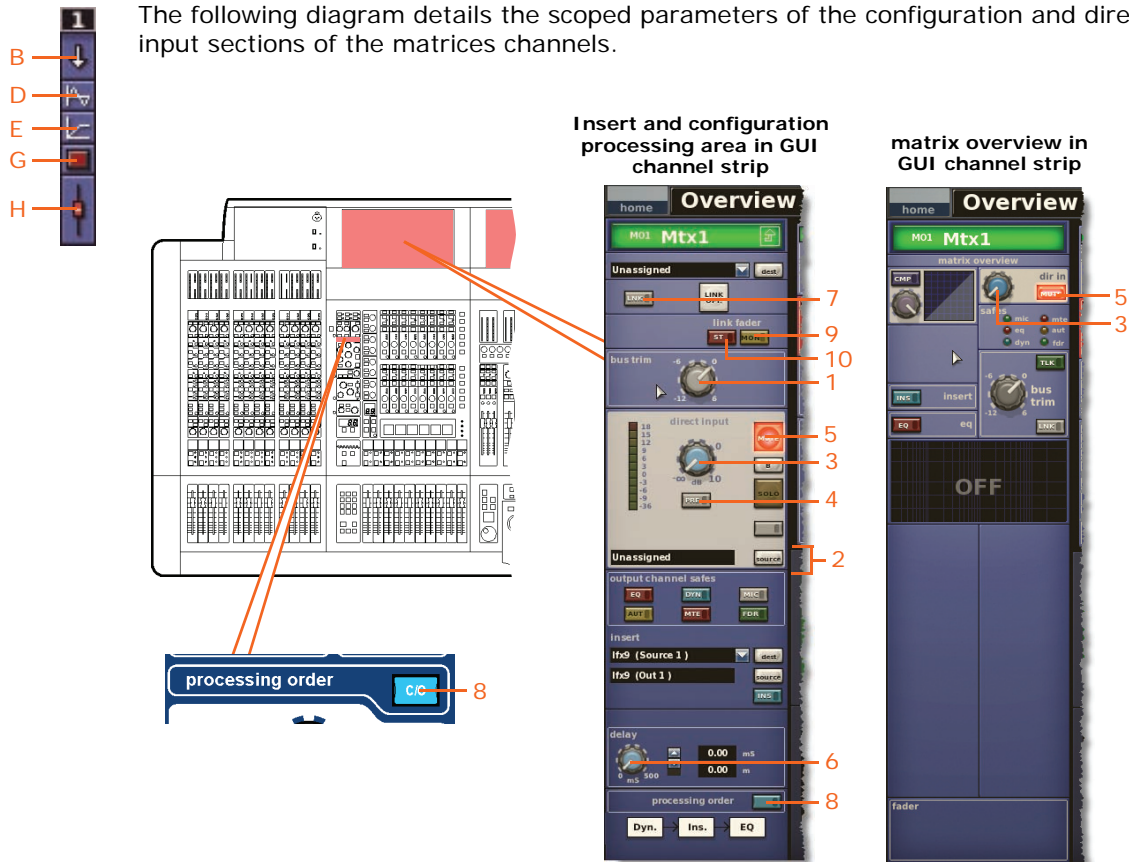

Item	Parameter	A	B	C	D	E	F	G	H
1	Bus trim	N/A	Yes	N/A	N/A	N/A	N/A	N/A	Yes
2	Direct input source	N/A	Yes ¹	N/A	N/A	N/A	N/A	N/A	N/A
3	Direct input level	N/A	Yes	N/A	N/A	N/A	N/A	N/A	N/A
4	Direct input pre-/post-	N/A	Yes	N/A	N/A	N/A	N/A	N/A	N/A
5	Direct input mute	N/A	Yes	N/A	N/A	N/A	N/A	Yes	N/A
6	Delay	N/A	Yes	N/A	N/A	N/A	N/A	N/A	Yes
7	Link	N/A	No	N/A	No	No	No	No	No
8	Process order	N/A	Yes	N/A	Yes	N/A	N/A	N/A	N/A
9	Link fader mono	N/A	Yes	N/A	N/A	N/A	N/A	N/A	Yes
10	Link fader stereo	N/A	Yes	N/A	N/A	N/A	N/A	N/A	Yes

1. Only when automate patching is on.

Dynamics

The following diagram details the scoped compressor parameters of the matrix channels. Although only the corrective compressor is shown below, this is typically the same for the other compressor modes (adaptive, creative, vintage and shimmer).

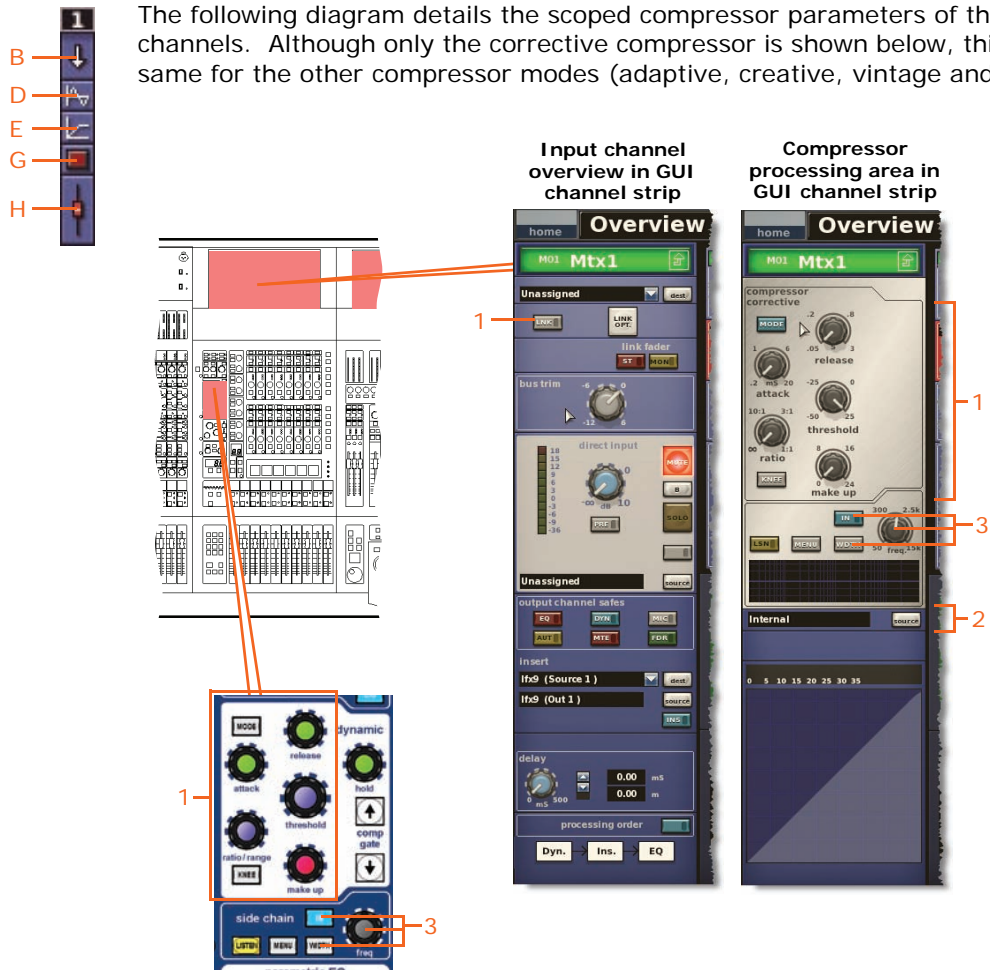

		A	B	C	D	E	F	G	H
Item	Parameter								
1	Compressor: attack, release, threshold, ratio/range/[ratio], make up, KNEE, MODE	N/A	Yes	N/A	N/A	Yes	N/A	N/A	N/A
2	Sidechain source	N/A	No	N/A	N/A	No	N/A	N/A	N/A
3	Compressor sidechain: IN, freq, and WIDTH	N/A	Yes	N/A	N/A	Yes	N/A	N/A	N/A

Insert



The following diagram details the scoped parameters in the insert section of the matrix channels.

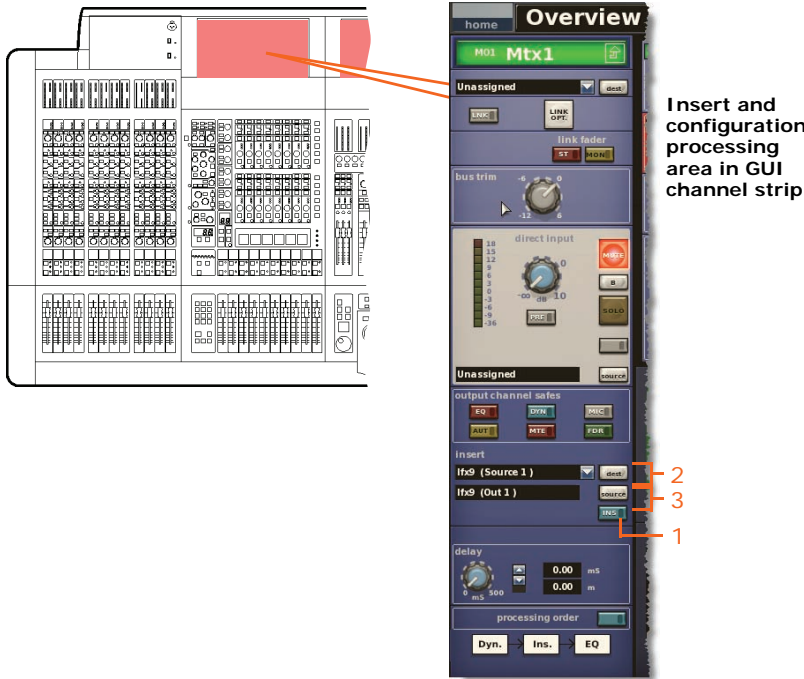

Insert and configuration processing area in GUI channel strip

		A	B	C	D	E	F	G	H
Item	Parameter								
1	In/out	N/A	Yes	N/A	N/A	N/A	N/A	N/A	N/A
2	Insert send destination	N/A	No	N/A	N/A	N/A	N/A	N/A	N/A
3	Insert return source	N/A	No	N/A	N/A	N/A	N/A	N/A	N/A

EQ

The following diagram details the scoped EQ parameters of the matrix channels.

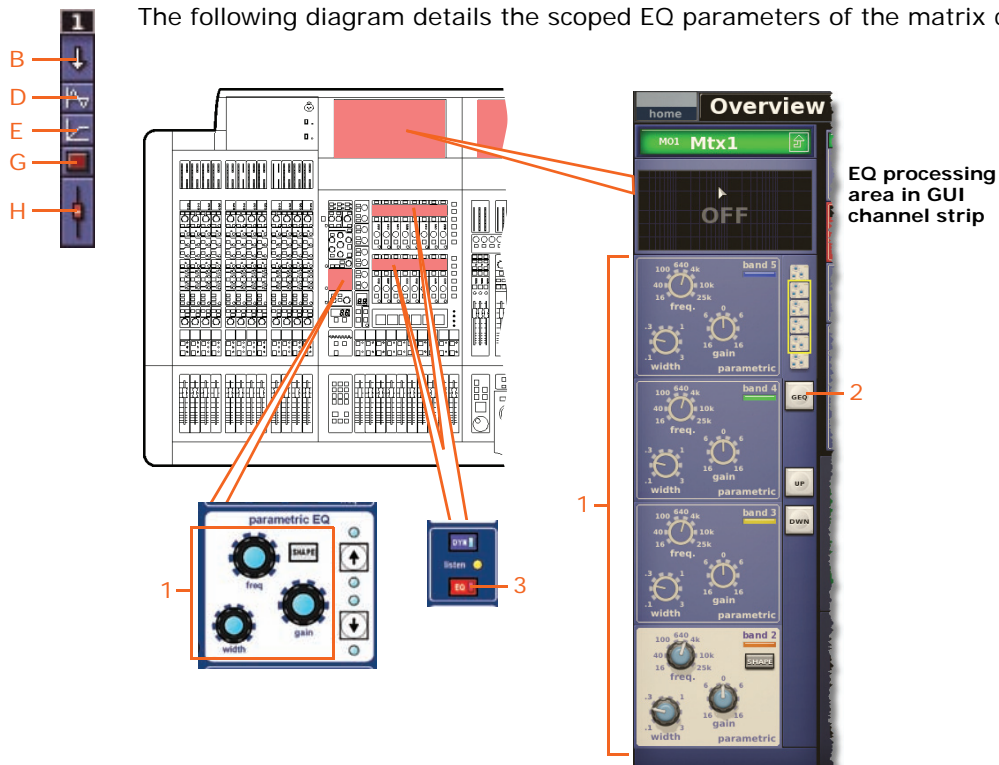

		A	B	C	D	E	F	G	H
Item	Parameter								
1	All PEQ filters (all six bands): freq, gain, width, SHAPE (as necessary)	N/A	Yes	N/A	Yes	N/A	N/A	N/A	N/A
2	Parametric/Graphic type	N/A	No	N/A	No	N/A	N/A	N/A	N/A
3	EQ in/out	N/A	Yes	N/A	Yes	N/A	N/A	N/A	N/A

Aux send

Not applicable.

Aux preset

Not applicable.

Matrix send

Not applicable.

Fader

The following diagram details the scoped fader parameters of the matrix channels.

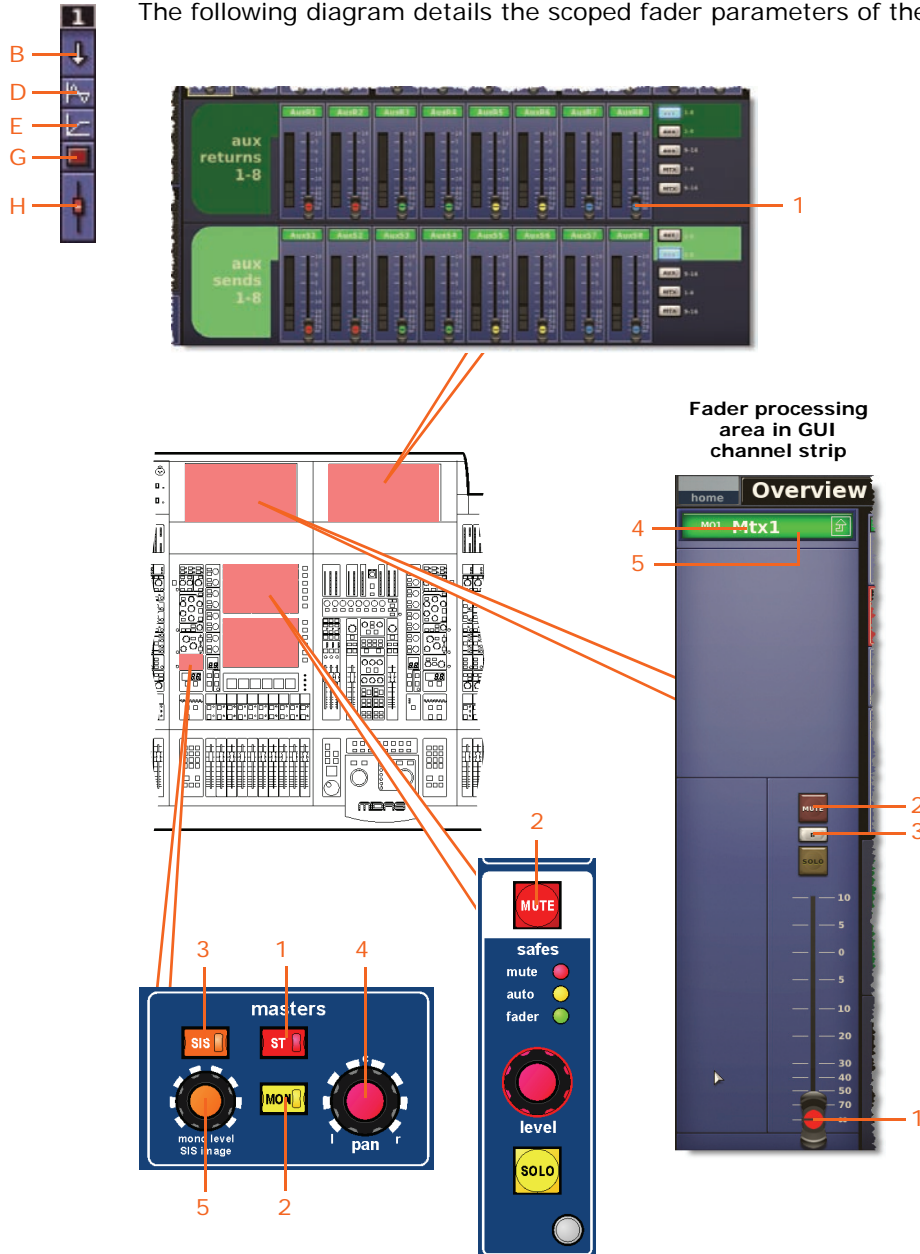

		A	B	C	D	E	F	G	H
Item	Parameter								
1	Fader position	N/A	Yes	N/A	N/A	N/A	N/A	N/A	Yes
2	Channel mute	N/A	Yes	N/A	N/A	N/A	N/A	Yes	No
3	Solo B assignment	N/A	No	N/A	N/A	N/A	N/A	N/A	No
4	Channel name	N/A	Yes	N/A	N/A	N/A	N/A	N/A	No
5	Channel colour	N/A	Yes	N/A	N/A	N/A	N/A	N/A	No

Masters

Each scope screen has three master channels (stereo left and right, and mono) in the **Masters** section.

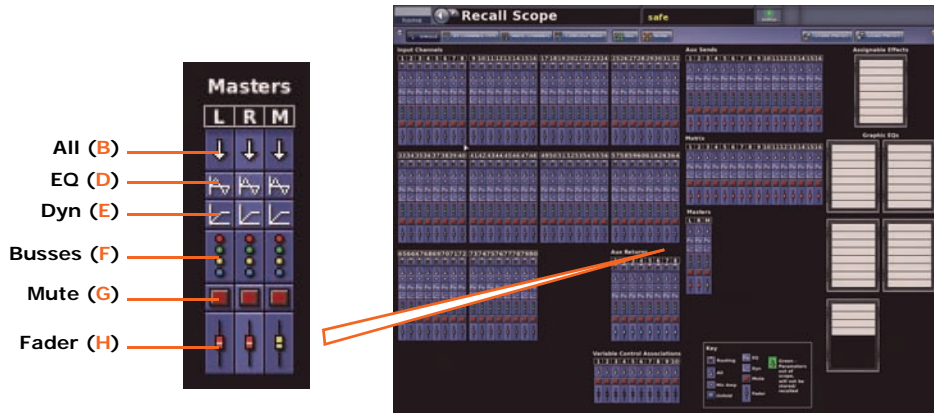

Parameter sections per master channel. There are 16 matrices per PRO6 and PRO9, and only eight on the PRO3. This example is taken from a PRO9.

Patching

The following diagram details the scoped patching parameters of the master channels.

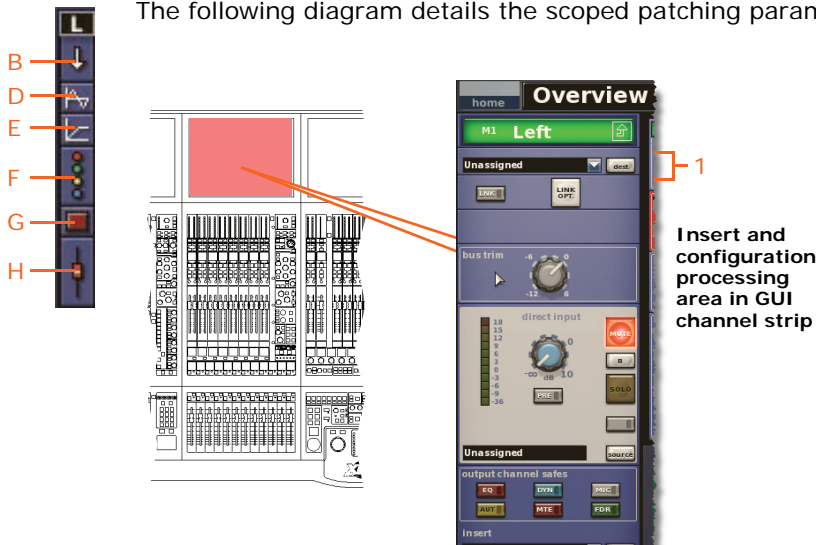

Item	Parameter	A	B	C	D	E	F	G	H
1	Output patching	N/A	No	N/A	N/A	N/A	N/A	N/A	N/A

Configuration

The following diagram details the scoped parameters in the configuration and direct input section of the master channels.

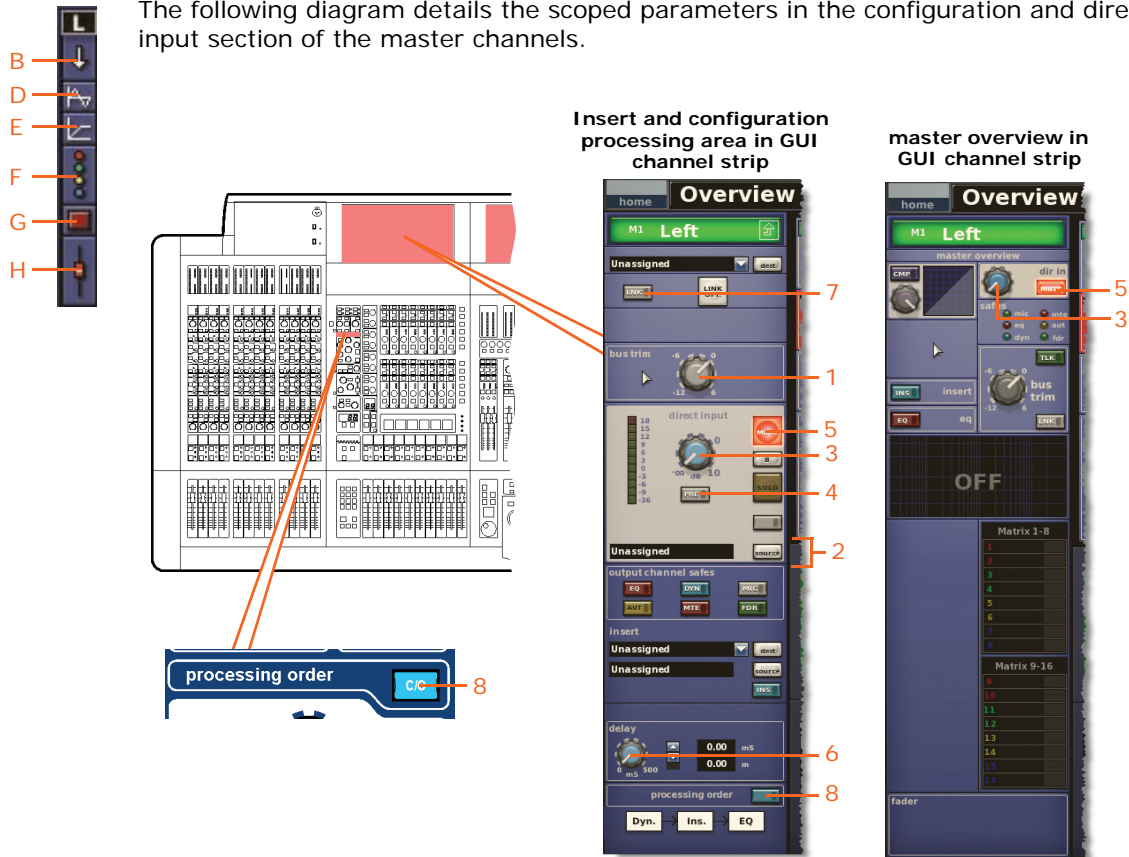

	A	B	C	D	E	F	G	H
Item								
Parameter								
1	N/A	Yes	N/A	N/A	N/A	N/A	N/A	Yes
2	N/A	Yes ¹	N/A	N/A	N/A	N/A	N/A	N/A
3	N/A	Yes	N/A	N/A	N/A	N/A	N/A	N/A
4	N/A	Yes	N/A	N/A	N/A	N/A	N/A	N/A
5	N/A	Yes	N/A	N/A	N/A	N/A	Yes	N/A
6	N/A	Yes	N/A	N/A	N/A	N/A	N/A	Yes
7	N/A	No	N/A	No	No	No	No	No
8	N/A	Yes	N/A	Yes	N/A	N/A	N/A	N/A

1. Only when automate patching is on.

Dynamics

The following diagram details the scoped compressor parameters of the master channels. Although only the corrective compressor is shown below, this is typically the same for the other compressor modes (adaptive, creative, vintage and shimmer).

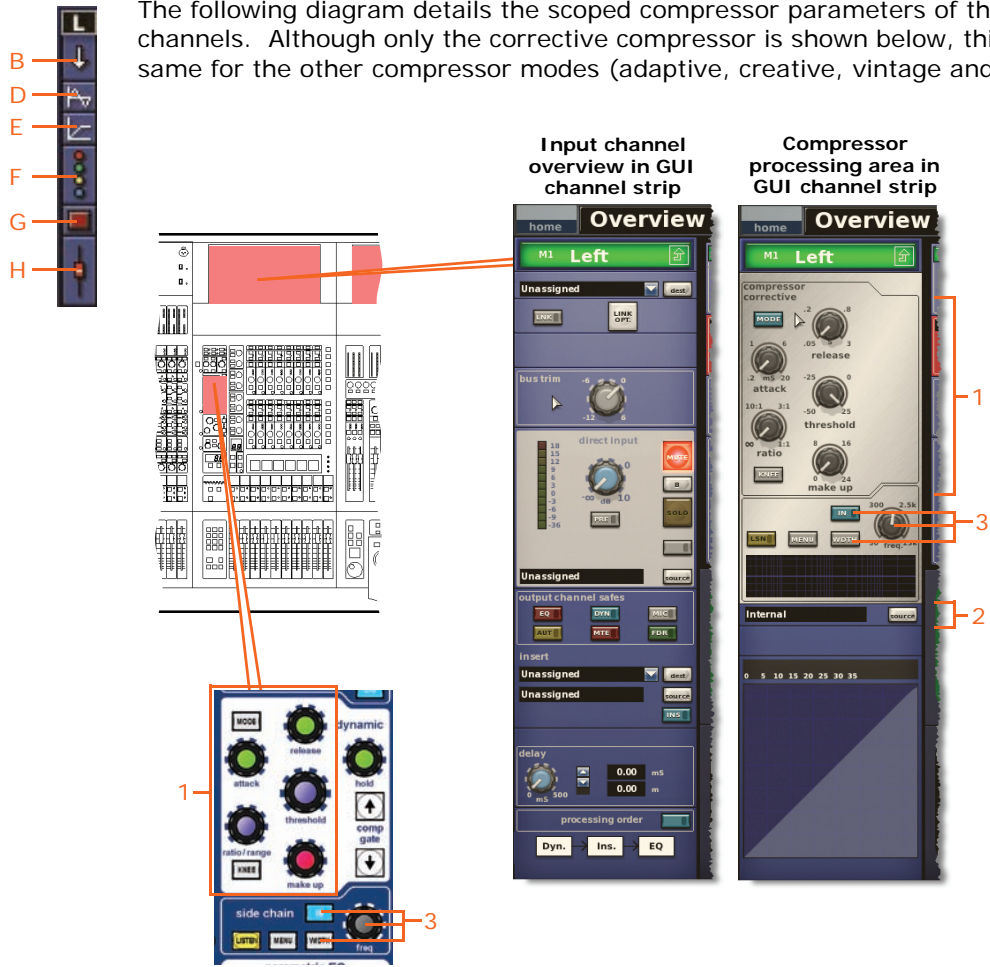

		A	B	C	D	E	F	G	H
Item	Parameter								
1	Compressor: attack , release , threshold , ratio/range/[ratio] , make up (gain), KNEE , MODE	N/A	Yes	N/A	N/A	Yes	N/A	N/A	N/A
2	Sidechain source	N/A	N/A	N/A	N/A	No	N/A	N/A	N/A
3	Compressor sidechain: IN , freq , and WIDTH	N/A	Yes	N/A	N/A	Yes	N/A	N/A	N/A

Insert

The following diagram details the scoped insert parameters of the master channels.

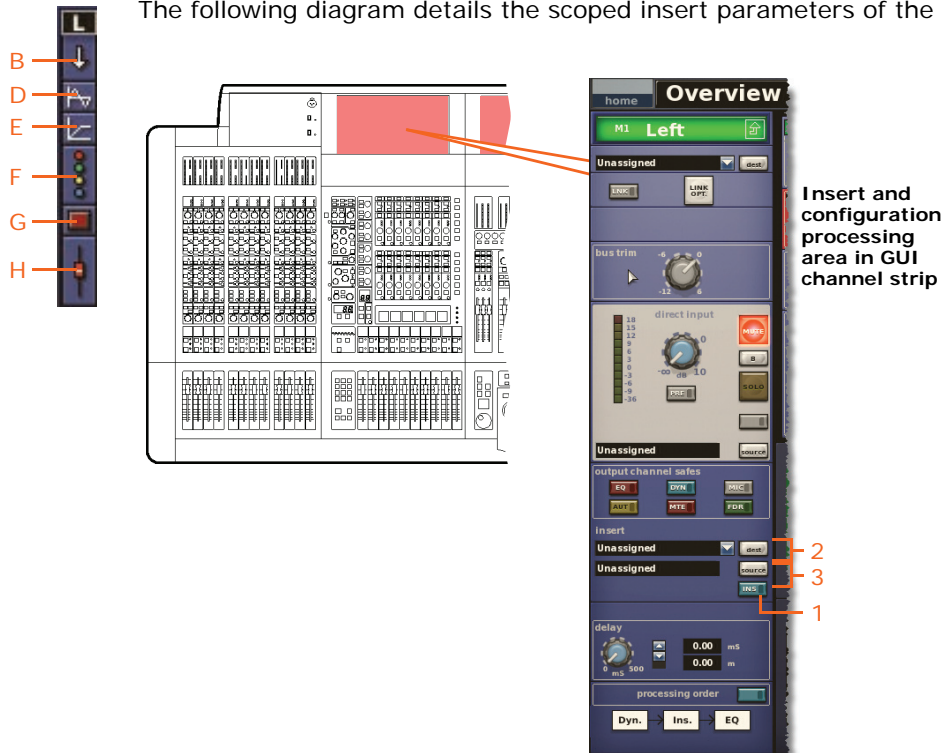

		A	B	C	D	E	F	G	H
Item	Parameter								
1	In/out	N/A	Yes	N/A	N/A	N/A	N/A	N/A	N/A
2	Insert send destination	N/A	No	N/A	N/A	N/A	N/A	N/A	N/A
3	Insert return source	N/A	No	N/A	N/A	N/A	N/A	N/A	N/A

EQ

The following diagram details the scoped EQ parameters of the master channels, and shows the EQ processing area in the GUI channel strip.

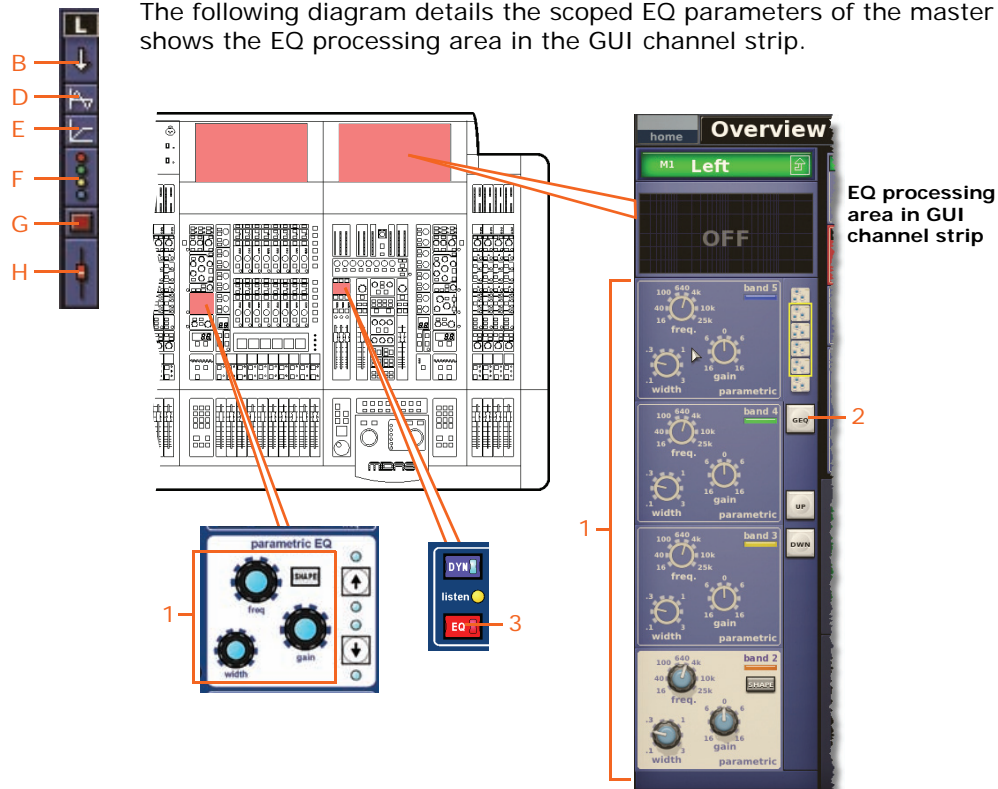

		A	B	C	D	E	F	G	H
Item	Parameter								
1	All PEQ filters (all six bands): freq, gain, width, SHAPE (as necessary)	N/A	Yes	N/A	Yes	N/A	N/A	N/A	N/A
2	Parametric/Graphic type	N/A	No	N/A	No	N/A	N/A	N/A	N/A
3	EQ in/out	N/A	Yes	N/A	Yes	N/A	N/A	N/A	N/A

Aux send

Not applicable

Aux preset

Not applicable

Matrix send

The following diagram details the scoped matrix send parameters of the master channels. Although only matrices 1 to 8 are shown below, this also applies to matrices 9 to 16 (PRO6 and PRO9 only).

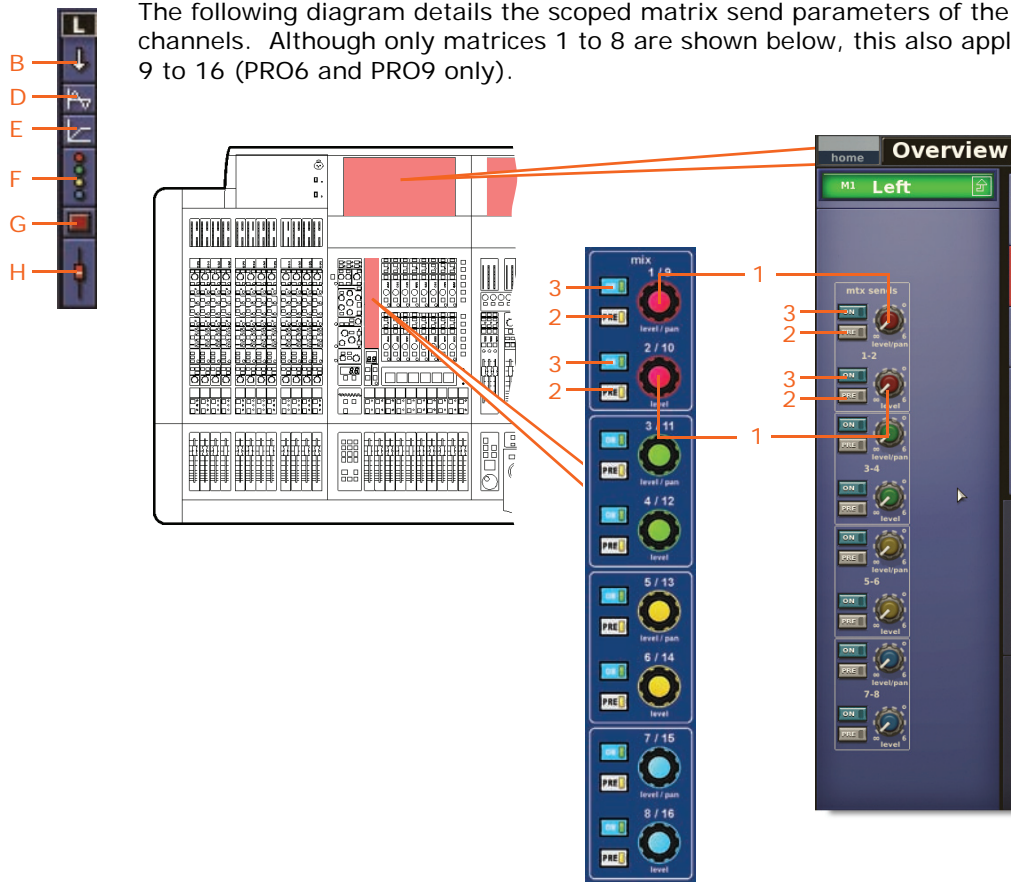

		A	B	C	D	E	F	G	H
Item	Parameter								
1	Send level	N/A	Yes	N/A	N/A	N/A	Yes	N/A	N/A
2	Send pre-fader on/off	N/A	Yes	N/A	N/A	N/A	Yes	N/A	N/A
3	Send on/off	N/A	Yes	N/A	N/A	N/A	Yes	N/A	N/A

You can scope individual bus sends. In column **B (All)**, all sends are affected, and in column **F (Busses)**, individual sends can be scoped.

Fader

The following diagram details the scoped fader parameters in the masters section of master channels, and shows the fader processing area in the GUI channel strip.

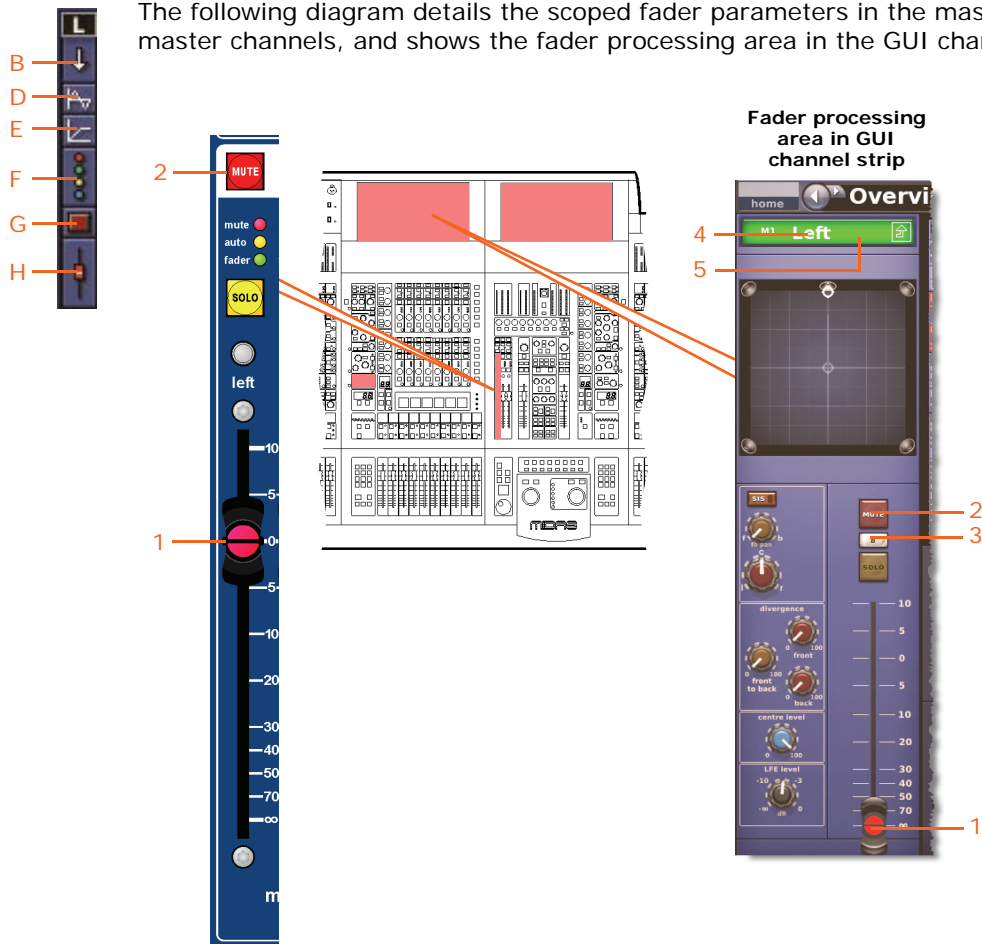

		A	B	C	D	E	F	G	H
1	Fader position	N/A	Yes	N/A	N/A	N/A	N/A	N/A	Yes
2	Channel mute	N/A	Yes	N/A	N/A	N/A	N/A	Yes	No
3	Solo B assignment	N/A	No	N/A	N/A	N/A	N/A	N/A	No
4	Channel name	N/A	Yes	N/A	N/A	N/A	N/A	N/A	No
5	Channel colour	N/A	Yes	N/A	N/A	N/A	N/A	N/A	No

GEQ rack

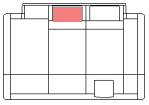

Each scope screen has up to five eight-slot racks in the **Graphic EQs** section, which can contain a maximum of 36 GEQs (as shown below). The number of racks and GEQs are configuration dependent.

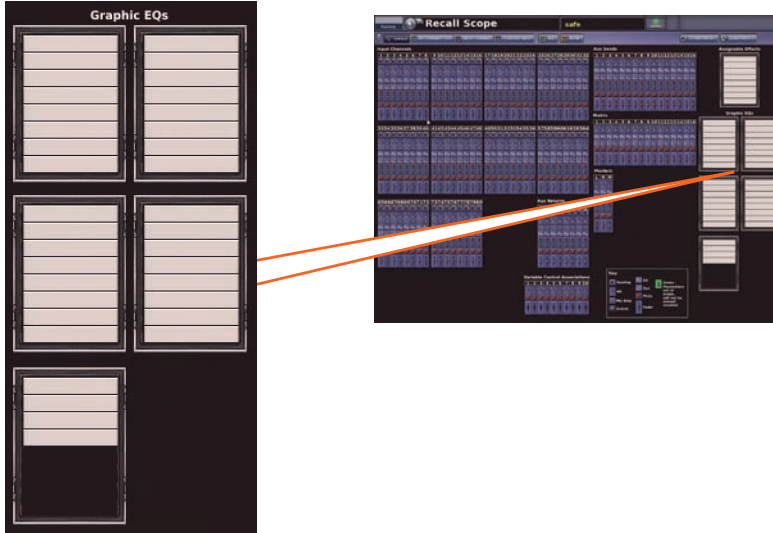

Graphic EQs represented on the **Recall Scope** screen. Racks are always shown fully populated, regardless of how many GEQs are configured. This example is taken from a PRO9.

Note: A rack slot in the **Graphic EQs** section is equivalent to a the **All**  scope area.

Patching

The following diagram details the scoped patching parameters of the GEQs, which are shown on the **Graphic GEQs** screen (below).

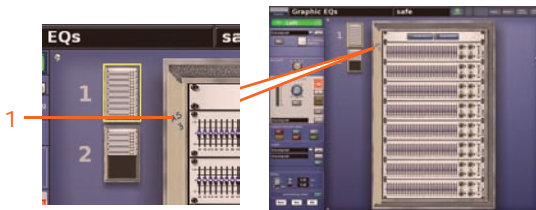

Item	Parameter	A	B	C	D	E	F	G	H
1	Bus assignment/type	N/A	No	N/A	N/A	N/A	N/A	N/A	N/A

GEQ

The following diagram details the scoped parameters of the GEQs, and shows the GEQ window on the GUI screen.

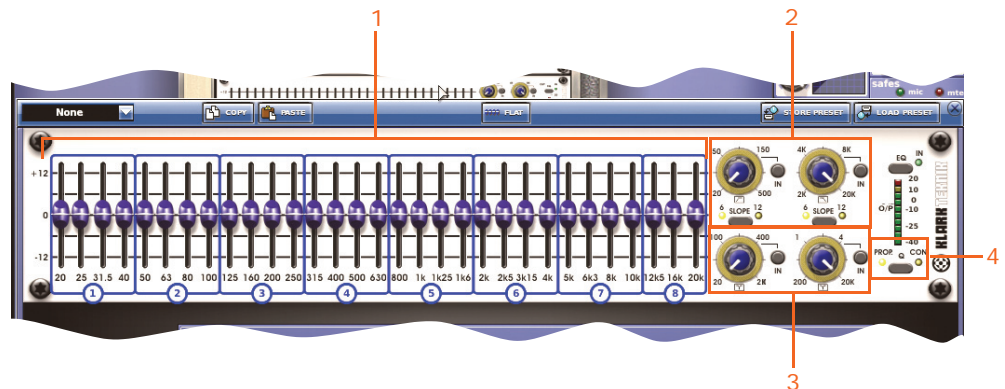

		A	B	C	D	E	F	G	H
Item	Parameter								
1	EQ band gains	N/A	Yes	N/A	N/A	N/A	N/A	N/A	N/A
2	HPF and LPF	N/A	Yes	N/A	N/A	N/A	N/A	N/A	N/A
3	Notch filters	N/A	Yes	N/A	N/A	N/A	N/A	N/A	N/A
4	GEQ mode (proportional/ constant Q)	N/A	Yes	N/A	N/A	N/A	N/A	N/A	N/A

Effects rack

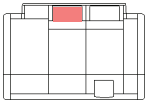

Each scope screen has single eight-position effects rack in the **Assignable Effects** section.

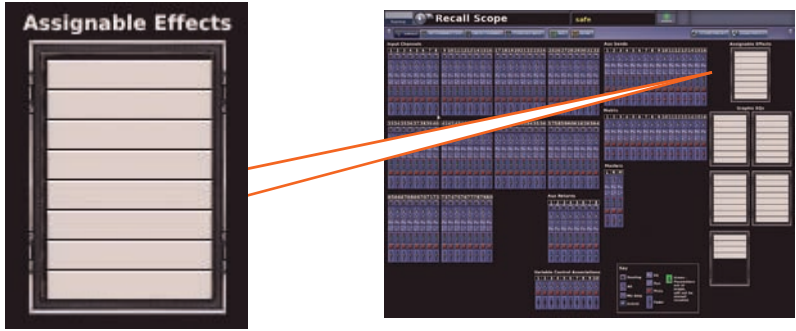







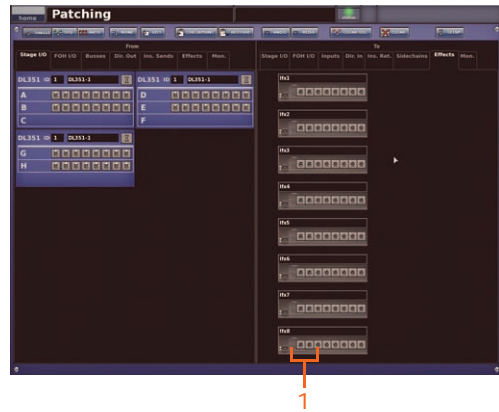

Assignable effects represented on the **Recall Scope** screen. Rack is always shown fully populated, regardless of how many effects are configured. This example is taken from a PRO9.

Note: A rack slot in the **Assignable Effects** section is equivalent to the **All**  scope area.

Patching

The diagram right shows the scoped patching parameters of the effects, which are on the **Effects** tab of the **To** section of the **Patching** screen.



		A	B	C	D	E	F	G	H
Item	Parameter								
1	Input patching	N/A	No	N/A	N/A	N/A	N/A	N/A	N/A

Effects

The following diagram details the scoped parameters of the effects, and shows the effect window on the GUI screen.



		A	B	C	D	E	F	G	H
Item	Parameter								
1	Effect name	N/A	Yes	N/A	N/A	N/A	N/A	N/A	N/A
2	Effect colour	N/A	Yes	N/A	N/A	N/A	N/A	N/A	N/A
3	Effect type	N/A	Yes	N/A	N/A	N/A	N/A	N/A	N/A
4	All effect parameters	N/A	Yes	N/A	N/A	N/A	N/A	N/A	N/A

Groups

Each scope screen contains 10 VCA groups in the **Variable Control Associates** section.

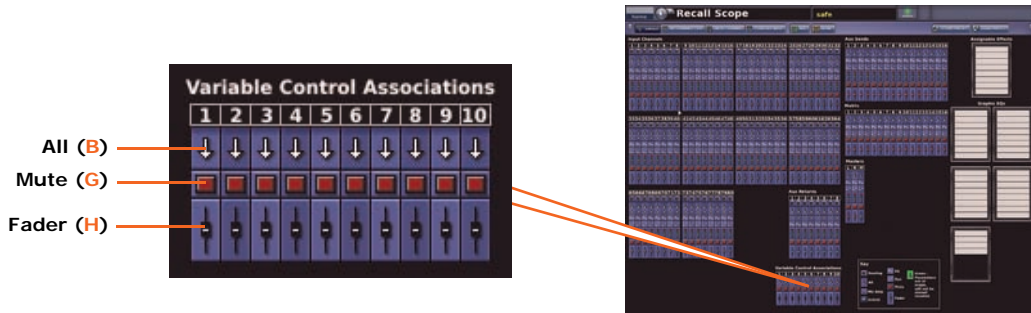

VCA groups represented on the **Recall Scope** screen. There are 10 VCA groups per PRO Series Control Centre. This example is taken from a PRO9.

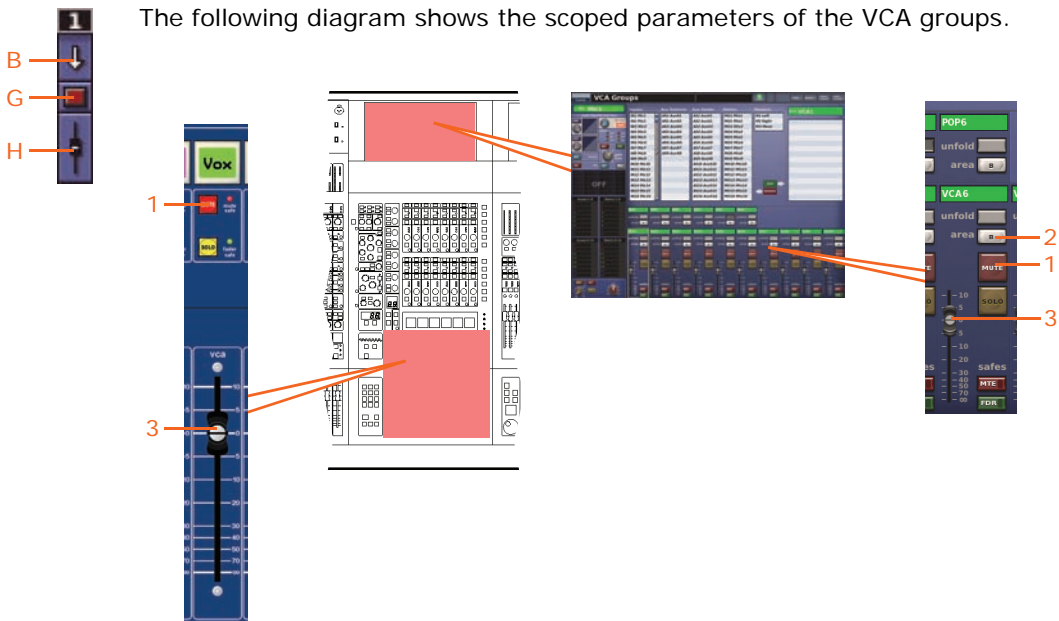

Item	Parameter	A	B	C	D	E	F	G	H
1	VCA mute	N/A	Yes	N/A	N/A	N/A	N/A	Yes	N/A
2	VCA area A and B	N/A	Yes	N/A	N/A	N/A	N/A	N/A	N/A
3	VCA fader level (required for surround panning)	N/A	Yes	N/A	N/A	N/A	N/A	N/A	Yes

Appendix L: Parameters Affected By Automate Patching

This appendix shows the patching parameters (sources) that can be changed on a per-scene basis in automation. These are only selectable when the **Automate Patching** option of the **Preferences** scene is selected (see "Using patching in automation" on page 208).

Note: Automate patching is not applicable to returns.

Inputs

The following input channel sources can be changed per scene.



Item	Parameter
1	Insert return source
2	Compressor side chain source
3	Gate key source

Although the mic input and tape input sources are automatable, that is, they can be changed per scene, they are controlled by the input patching recall scope area switch. They are not affected by the **Automate Patching** function.

Input patching recall scope area switches



Auxes

The source of each aux channel can be changed per scene.

Item	Parameter
1	Insert return source
2	Direct in source
3	Compressor side chain source



Configuration processing area



Compressor processing area

Matrices

The destinations/sources of each matrix channel can be changed per scene.

Item	Parameter
1	Insert return source
2	Direct in source
3	Compressor side chain source



Configuration processing area



Compressor processing area

Masters

The destinations/sources of each master channel can be changed per scene.

Item	Parameter
1	Insert return source
2	Direct in source
3	Compressor side chain source



Configuration processing area



Compressor processing area

Effects

Effect input sources can be changed per scene.



Patching screen showing the location of the effects in the **Effects** tab of the **To** section. (PRO3 only has a maximum of six effects.)

System devices

Sources for the outputs of external devices, such as the DL251 Audio System I/O, DL351 Modular I/O, DL451 Modular I/O, DN9696 Recorder, etc., can be changed per scene. The sources are selectable via the **Stage I/O** and **FOH I/O** tabs in **To** section of the **Patching** screen.

However, this does not include the I/O card configuration.

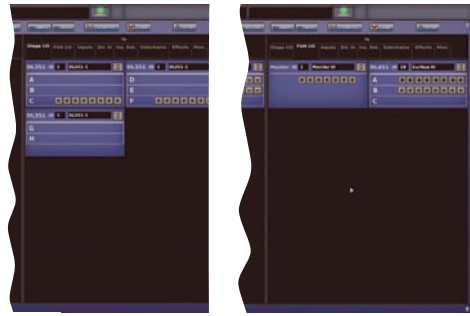

Monitors

The following monitor sources, shown on the **Monitors** screen (see below), can be changed per scene.



Item	Parameter
1	Talk input source
2	Talkback input source
3	PFL direct input source
4	AFL direct input left source
5	AFL direct input right source
6	External monitor input left source
7	External monitor input right source

Appendix M: Parameters Protected By Safes

This appendix shows the parameters affected by each of the safe types (**EQ**, **DYN**, **MIC**, **AUTO**, **MUTE** and **FADER**).

The parameter areas for the scopes (store and recall) and the safes are, basically the same. However, the way they are presented in their respective appendices is different. This may provide you with a useful alternative when referring to this material, should you prefer one more than the other (see Appendix K "Parameters Affected By Scope" on page 421).

Note: Some of the GUI displays in this appendix may look slightly different to the ones on the PRO Series Control Centre you are using, as they may be taken from a different type of PRO Series Live Audio System. For example, the PRO3 doesn't have a **Matrix 9 - 16** section in the GUI channel strip. However, all of the parameters protected by the safes still apply.

Overview

The following table provides a quick reference for finding the channel/group safe areas in this appendix.

<i>Channel or Group</i>	<i>EQ safe</i>	<i>DYN safe</i>	<i>MIC safe</i>	<i>AUTO safe</i>	<i>MUTE safe</i>	<i>FADER safe</i>
Input channel	"EQ safe" on page 472	"DYN (dynamic) safe" on page 473	"MIC safe" on page 475	"AUTO (automatic) safe" on page 476	"MUTE safe" on page 476	"FADER safe" on page 477
Aux	"EQ safe" on page 480	"DYN (dynamic) safe" on page 482	"MIC safe" on page 483	"AUTO (automatic) safe" on page 483	"MUTE safe" on page 484	"FADER safe" on page 485
Return	N/A	N/A	"MIC safe" on page 488	"AUTO (automatic) safe" on page 489	"MUTE safe" on page 489	"FADER safe" on page 490
Matrix	"EQ safe" on page 493	"DYN (dynamic) safe" on page 495	"MIC safe" on page 496	"AUTO (automatic) safe" on page 496	"MUTE safe" on page 497	"FADER safe" on page 498
Master	"EQ safe" on page 501	"DYN (dynamic) safe" on page 503	"MIC safe" on page 504	"AUTO (automatic) safe" on page 504	"MUTE safe" on page 505	"FADER safe" on page 506
VCA group	N/A	N/A	N/A	"Automatic safe" on page 508	"Mute (MTE) safe" on page 509	"Fader (FDR) safe" on page 510

Inputs

The input safes are selected via the **channel safes** section of the channel strip in the mix bay (control surface) or the **input channel safes** section of the configuration processing area (GUI channel strip).

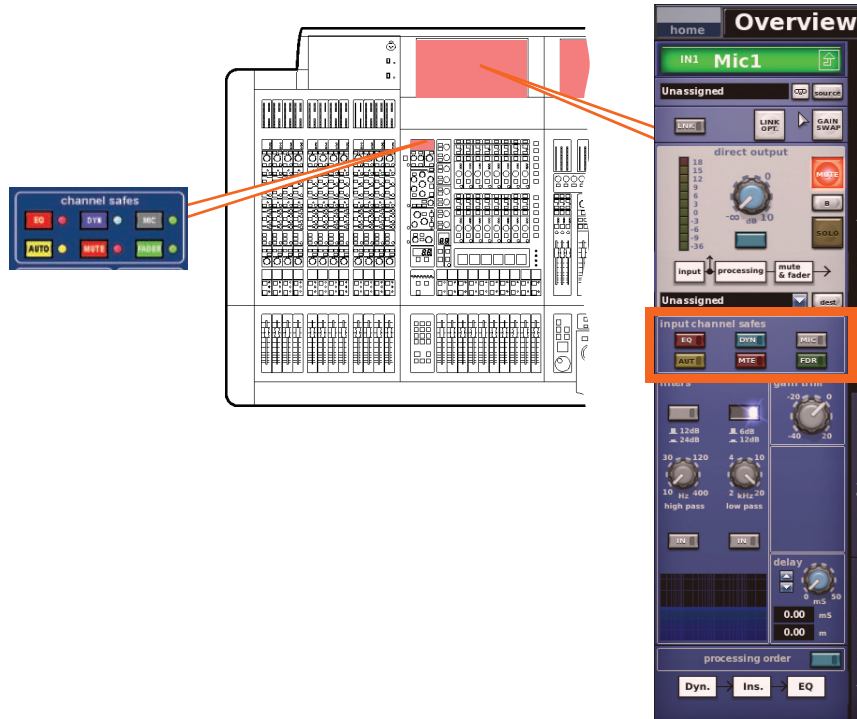

Input parameters not affected by the safes

The following input channel parameters are *not* affected by any of the safes.

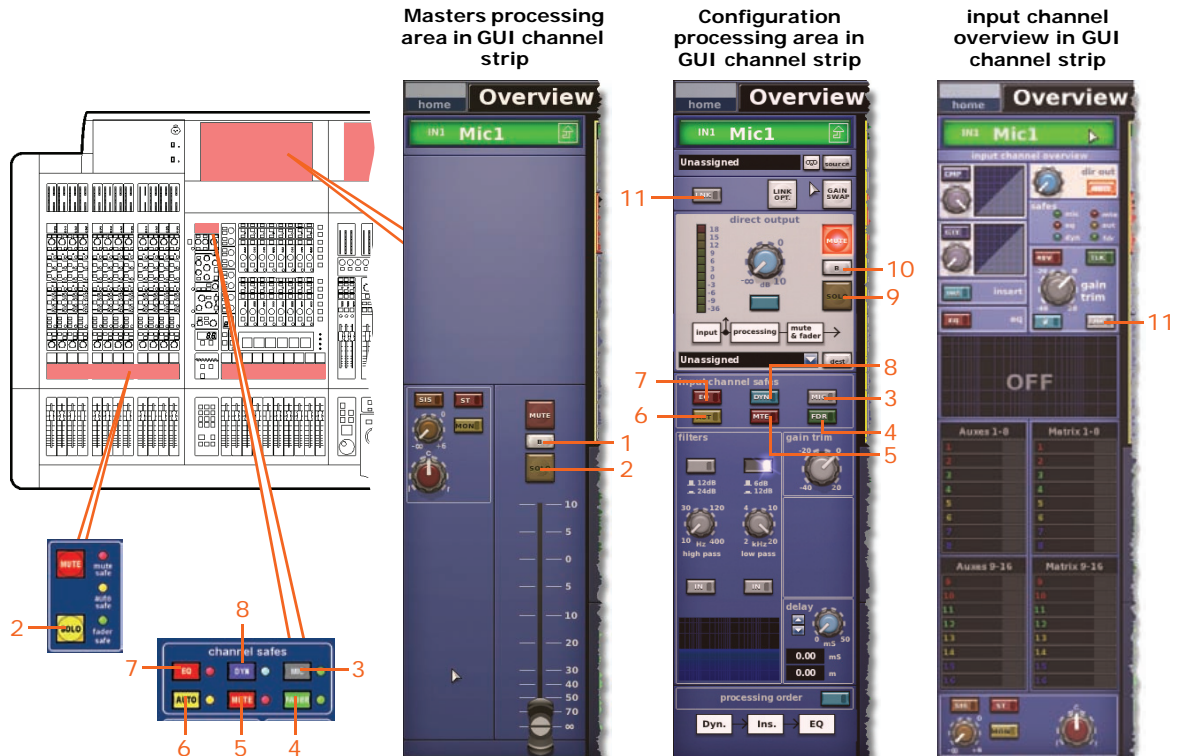

Item	Control	Parameter
1	B switch	Solo B on/off
2	SOLO switch	Solo on/off
3	MIC switch	Mic safe on/off
4	FADER/[FDR] switch	Fader safe on/off
5	MUTE/[MTE] switch	Mute safe on/off
6	AUTO/[AUT] switch	Automation safe on/off
7	EQ switch	EQ safe on/off
8	DYN switch	Dynamic safe on/off
9	SOLO switch	Direct output solo on/off
10	B switch	Direct output solo B on/off
11	LNK switch	Stereo linking on/off

EQ safe

The following diagram details the parameters in the inputs affected by the **EQ** safe, and shows the EQ processing area in the GUI channel strip.

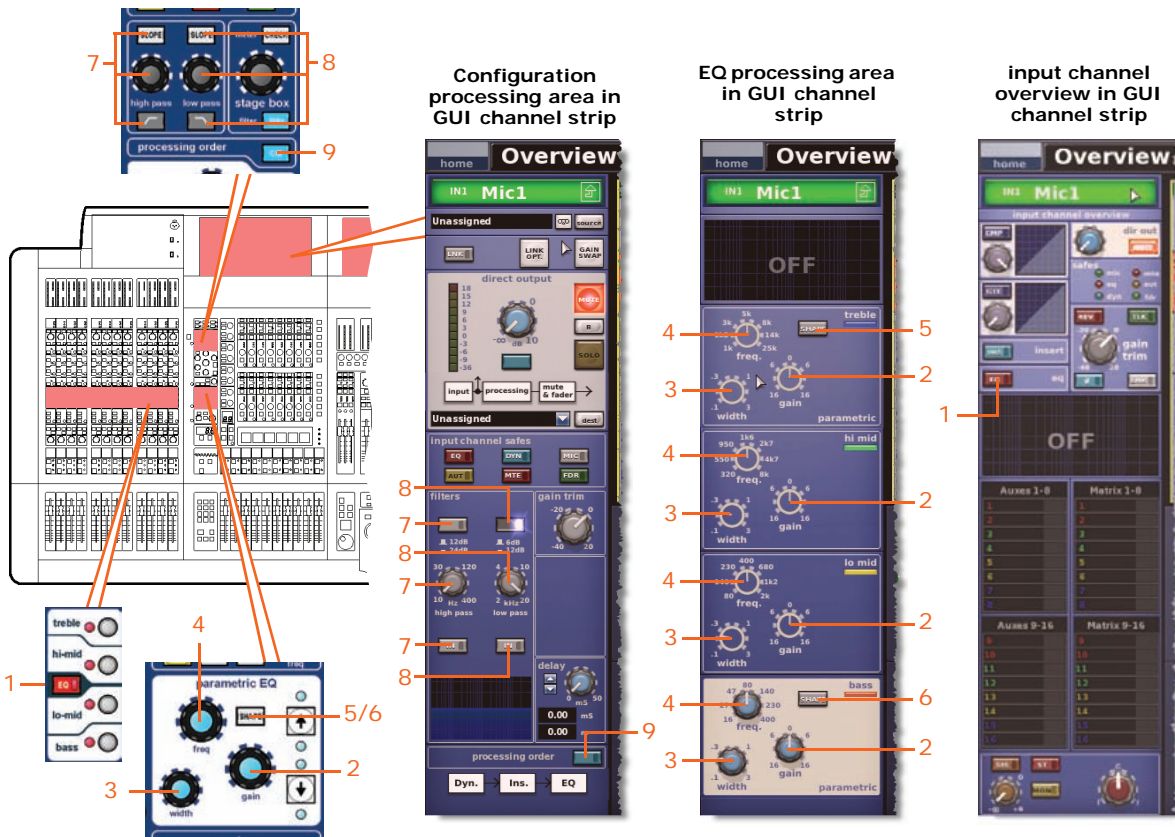

Item	Control(s)	Parameter
1	EQ switch	EQ on/off
2	gain control knob	EQ gain level
3	width control knob	EQ width
4	freq control knob	EQ frequency
5	SHAPES switch	Selects treble shelving mode: peaking, bright, classic or soft
6	SHAPES switch	Selects bass shelving mode: peaking, deep, classic or warm
7	SLOPE switch, high pass control knob, <input type="checkbox"/> /[IN] switch	High pass filter
8	SLOPE switch, low pass control knob, <input type="checkbox"/> /[IN] switch	Low pass filter
9	C/O switch	Order of processing: Dyn. → Ins. → EQ or EQ → Ins. → Dyn.

DYN (dynamic) safe

The following diagram details the parameters in the inputs protected by DYN safe.

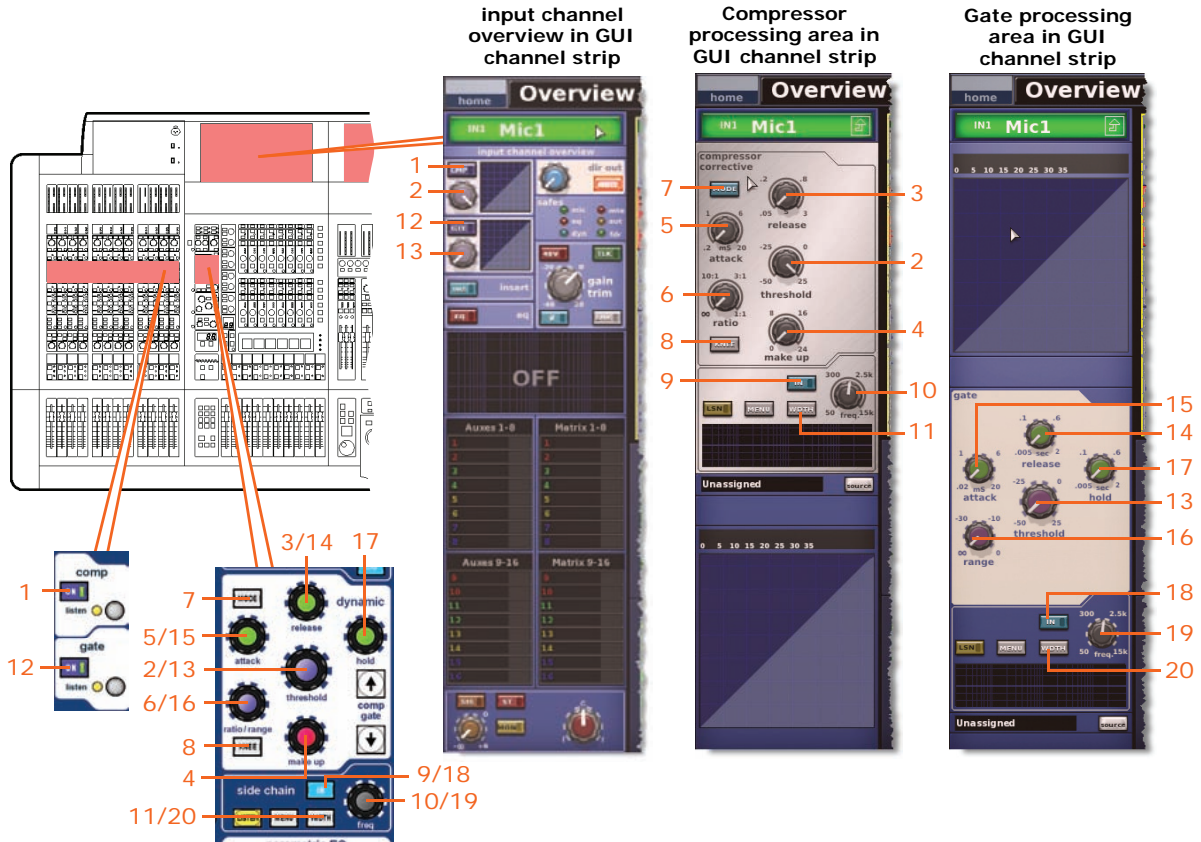

Note: Only the corrective compressor is shown above, but this is typically the same for the other compressor modes (adaptive, creative and vintage).

Item	Control	Parameter
1	ON switch	Compressor on/off
2	threshold control knob	Compressor threshold
3	release control knob	Compressor release
4	make up control knob	Compressor make up gain
5	attack control knob	Compressor attack
6	ratio/range/[ratio] control knob	Compressor ratio
7	MODE pushbutton	Compressor mode: corrective (shown above), adaptive, creative or vintage
8	KNEE pushbutton	Compressor knee: hard, medium or soft
9	IN switch	Compressor sidechain in/out
10	freq control knob	Compressor sidechain frequency

<i>Item</i>	<i>Control</i>	<i>Parameter</i>
11	WIDTH pushbutton	Compressor sidechain width: 2 Oct, 1 Oct or 0.3 Oct
12	ON switch	Gate on/off
13	threshold control knob	Gate threshold
14	release control knob	Gate release
15	attack control knob	Gate attack
16	ratio/range/[range] control knob	Gate range
17	hold control knob	Gate hold
18	IN switch	Gate sidechain in/out
19	freq control knob	Gate sidechain frequency
20	WIDTH pushbutton	Gate sidechain width: 2 Oct, 1 Oct or 0.3 Oct

MIC safe

The following diagram details the parameters in the inputs protected by MIC safe.

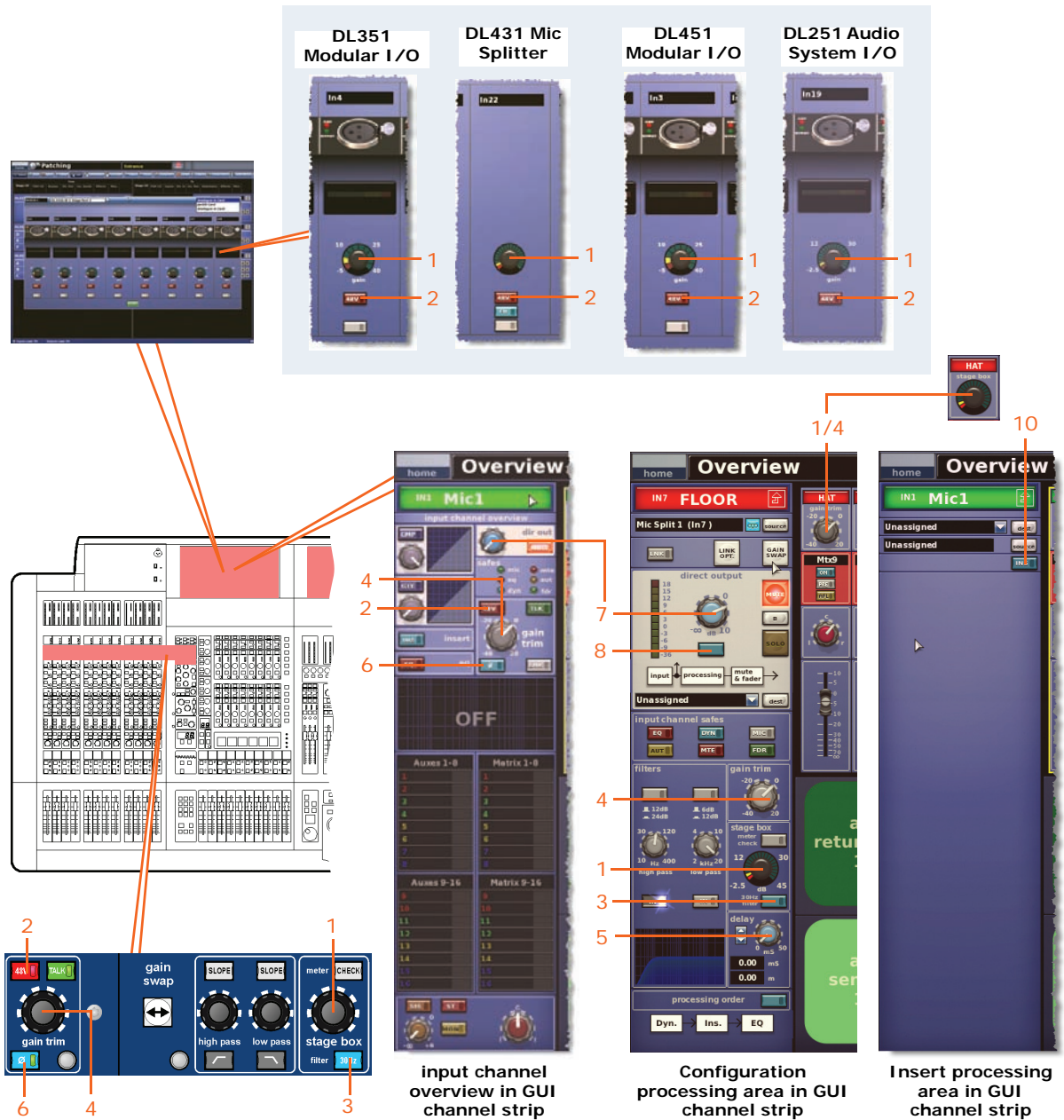

Item	Control	Parameter
1	stage box control knob*	Gain of remote amplifier
2	48V switch	48V phantom gain
3	30Hz switch	30Hz filter
4	gain trim control knob*	Digital input trim
5	Delay control knob	Delay time
6	Ø switch	Input phase invert on/off

Item	Control	Parameter
7	Control knob	Direct output level
8	MODE switch	Direct output tap-off point: "Post-fade and mute", "Pre-mute, pre-processing" or "Pre-mute, post-processing"

* Depends on swap status.

AUTO (automation) safe

All of the input channel parameters are protected by the **AUTO** safe — except, of course, for the ones unaffected by the safes (see "Input parameters not affected by the safes" on page 471).

MUTE safe

The following diagram details the parameters in the inputs protected by **MUTE** safe.

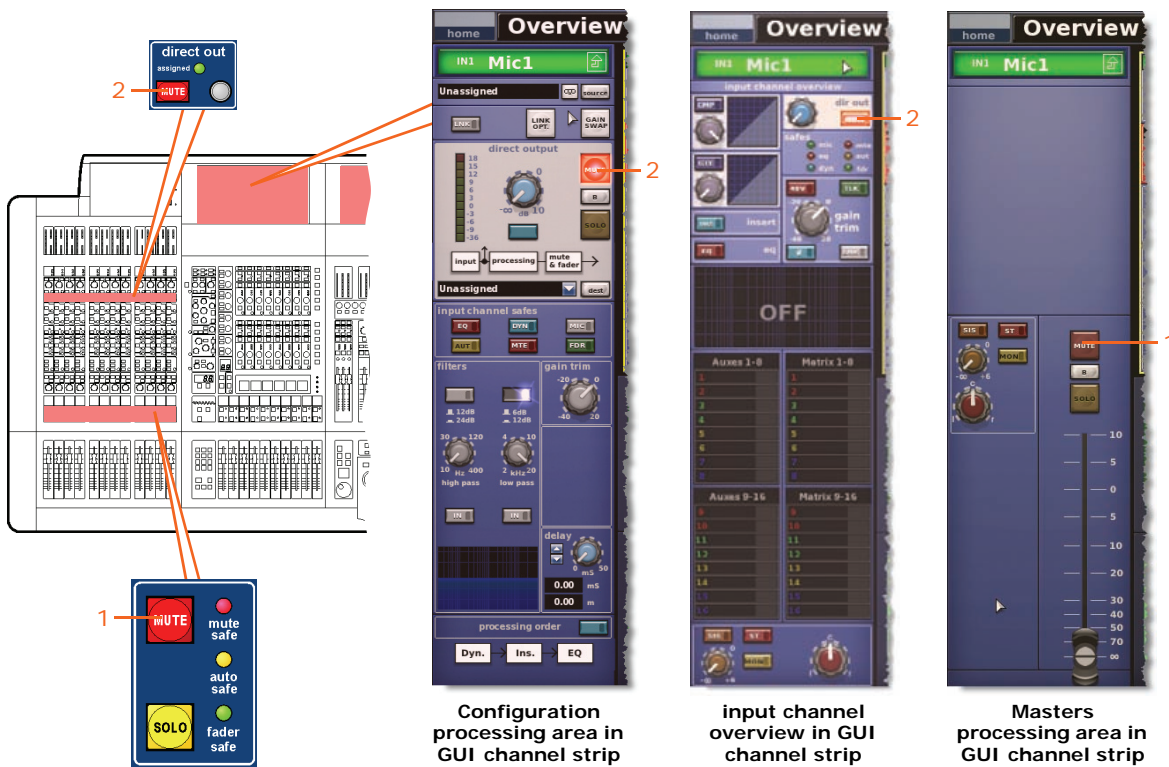

Item	Control	Parameter
1	MUTE switch	Mute on/off
2	MUTE switch	Direct output mute on/off

FADER safe

The following diagram details the parameters in the inputs protected by **FADER** safe.

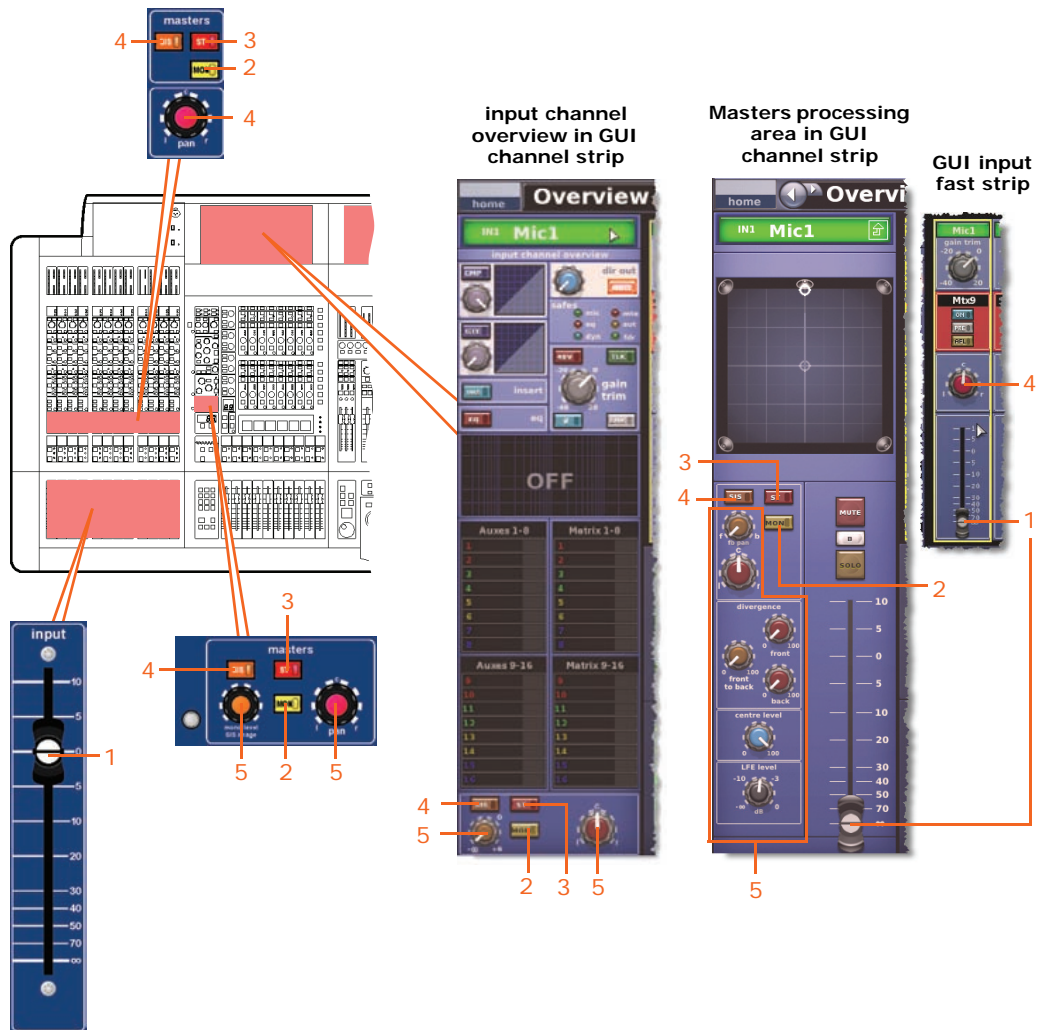

<i>Item</i>	<i>Control(s)</i>	<i>Parameter</i>
1	Fader	Fader level
2	MON switch	Mono routing on/off
3	ST switch	Stereo routing on/off
4	SIS switch	Spatial imaging system on/off
5	Panning control knobs	Surround panning (includes all surround sound parameters)

Auxes (Aux Sends)

The aux safes are selected via the **channel safes** section of the channel strip in the mix bay (control surface) or the **output channel safes** section of the insert and configuration processing area (GUI channel strip).

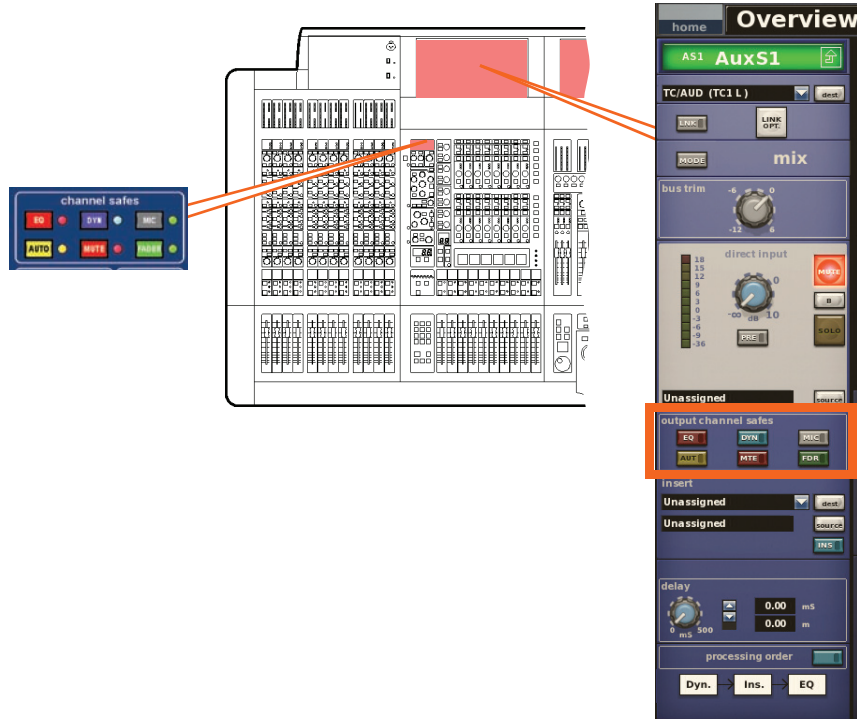

Aux parameters not affected by the safes

The following aux parameters are *not* affected by any of the safes.

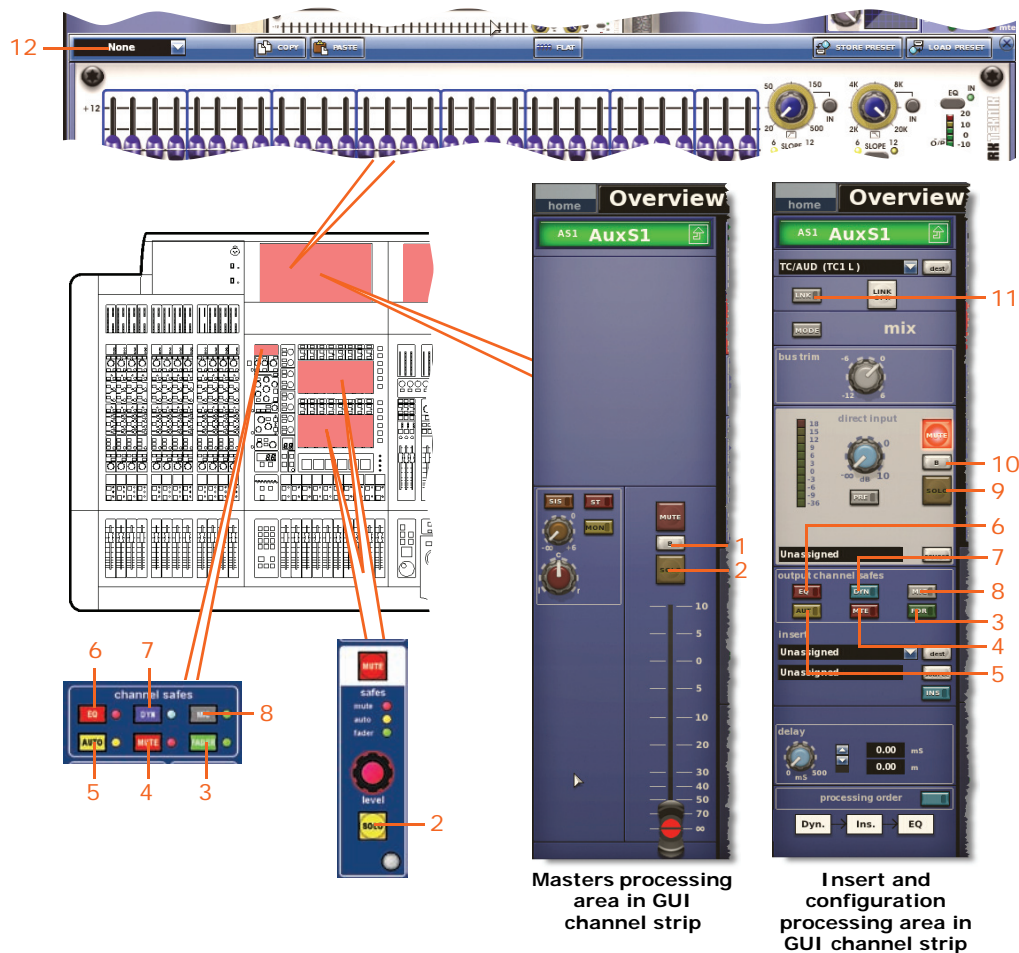

Item	Control	Parameter
1	B switch	Solo B on/off
2	SOLO switch	Solo on/off
3	FADER/[FDR] switch	Fader safe on/off
4	MUTE/[MTE] switch	Mute safe on/off
5	AUTO/[AUT] switch	Automation safe on/off
6	EQ switch	EQ safe on/off
7	DYN switch	Dynamic safe on/off
8	MIC switch	Mic safe on/off
9	SOLO switch	Direct input solo on/off
10	B switch	Direct input solo B on/off
11	LNK switch	Stereo linking on/off
12	Field	GEQ assignment

EQ safe

The following diagram details the parameters in the auxes protected by the EQ safe.

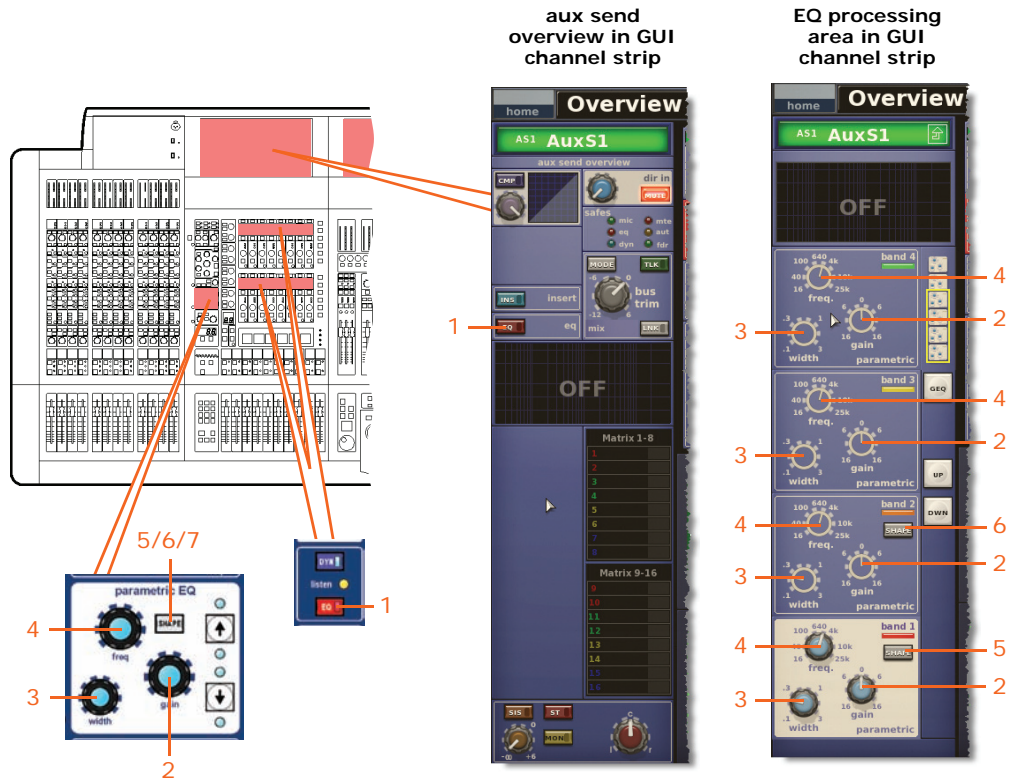

Item	Control	Parameter
1	EQ switch	EQ on/off
2	gain control knob	EQ gain level
3	width control knob	EQ width
4	freq control knob	EQ frequency
5	SHAPe switch	Band 1 shelving mode: bell, warm, high pass 6dB or high pass 12dB
6	SHAPe switch	Band 2 shelving mode: bell or high pass 24dB
7*	SHAPe switch	Band 6 shelving mode: bell, soft, low pass 6dB or low pass 12dB

* Not shown in diagram.

Note: Although band 6 is not shown above, the items in the table also apply. This band has items 2, 3 and 4, and also item 7.

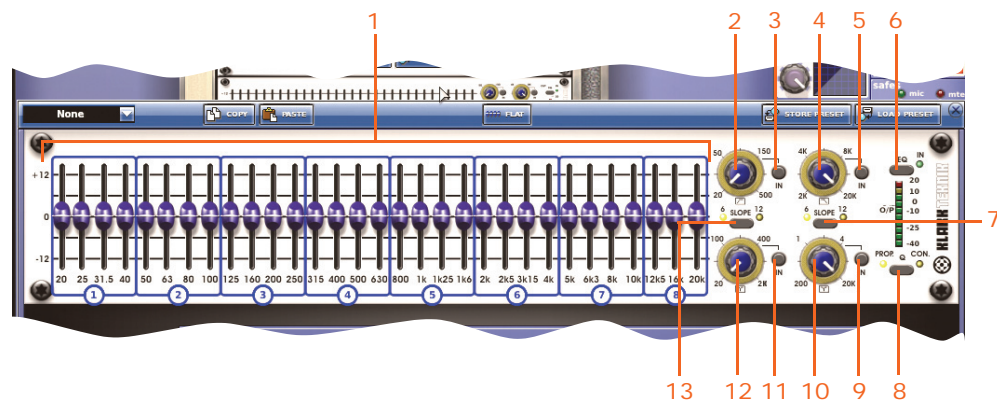

<i>Item</i>	<i>Control</i>	<i>Parameter</i>
1	31 faders	Fader positions
2	High pass filter control knob	High pass filter cut off frequency
3	IN switch	High pass filter in/out
4	Low pass filter control knob	Low pass filter cut off frequency
5	IN switch	Low pass filter in/out
6	EQ switch	EQ in/out
7	SLOPE switch	Selects low pass filter as 6dB or 12dB
8	Q switch	Selects Q mode as proportional (PROP.) or constant (CON.)
9	IN switch	Switches 200Hz - 20kHz notch filter in/out
10	Notch filter control knob	200Hz - 20kHz notch filter frequency
11	IN switch	Switches 20Hz - 2kHz notch filter in/out
12	Notch filter control knob	20Hz - 2kHz notch filter frequency
13	SLOPE switch	Selects high pass filter as 6dB or 12dB

DYN (dynamic) safe

The following diagram details the parameters in the auxes protected by the **DYN** safe. Only the corrective compressor is shown, but this is typically the same for the other compressor modes (adaptive, creative, vintage and shimmer).

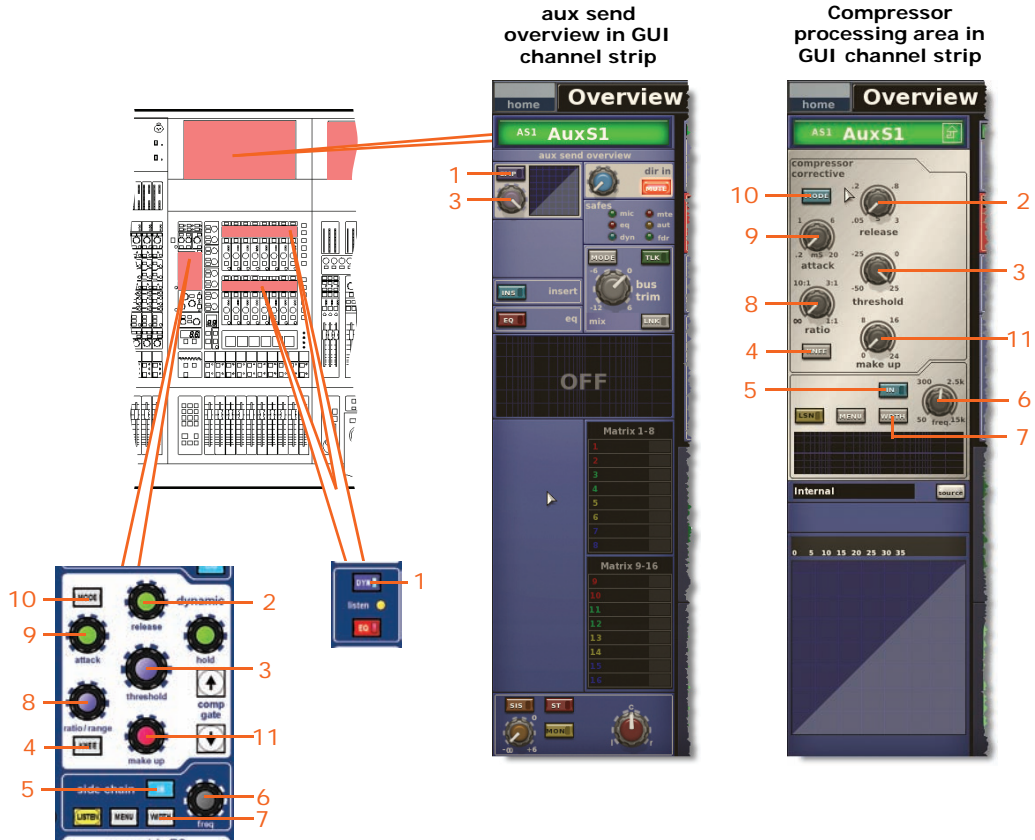

Item	Control	Parameter
1	DYN /[CMP] switch	Compressor on/off
2	release control knob	Compressor release
3	threshold control knob	Compressor threshold
4	KNEE pushbutton	Compressor knee selector: hard, medium and soft
5	IN switch	Compressor sidechain in/out
6	freq control knob	Compressor sidechain frequency
7	WIDTH pushbutton	Compressor sidechain width (unlabelled): 2 Oct, 1 Oct or 0.3 Oct
8	ratio/range /[ratio] control knob	Compressor ratio
9	attack control knob	Compressor attack
10	MODE pushbutton	Compressor mode — corrective, adaptive, creative, vintage or shimmer
11	make up control knob	Compressor gain

MIC safe

The following diagram details the parameters in the auxes protected by the **MIC** (configuration) safe.

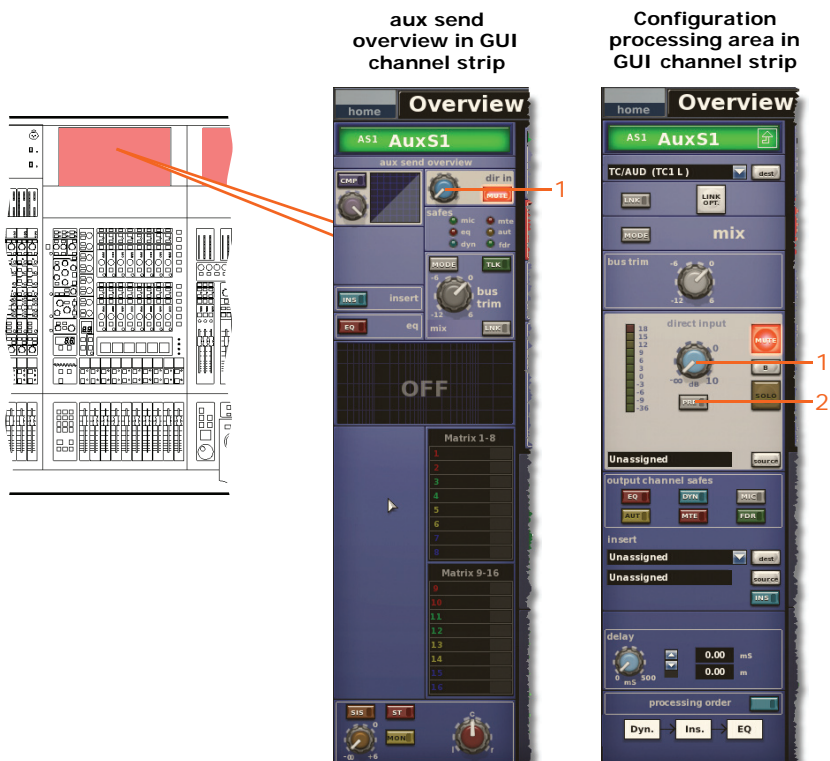

Item	Control	Parameter
1	Control knob	Direct input level
2	PRE switch	Direct input pre- in/out

AUTO (automation) safe

All of the aux channel parameters are protected by the **AUTO** (automation) safe — except, of course, for the ones unaffected by the safes (see “Aux parameters not affected by the safes” on page 479).

MUTE safe

The following diagram details the parameters of the auxes protected by the **MUTE** safe.

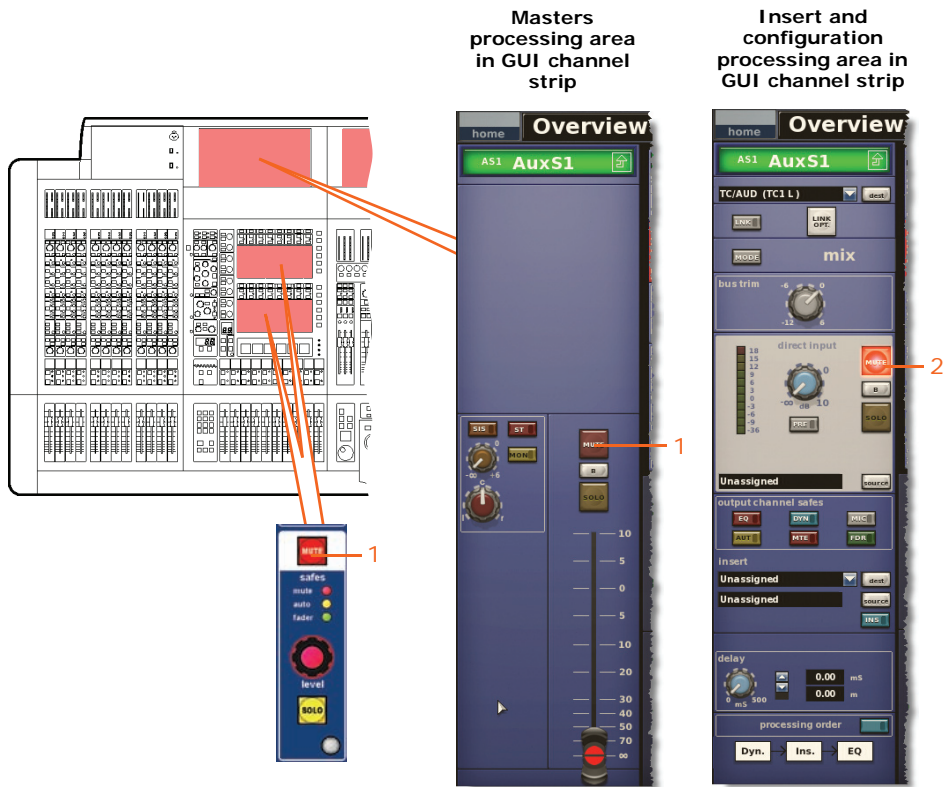

<i>Item</i>	<i>Control</i>	<i>Parameter</i>
1	MUTE switch	Mute on/off
2	MUTE switch	Direct input mute on/off

FADER safe

The following diagram details the parameters of the auxes protected by the **FADER** safe.

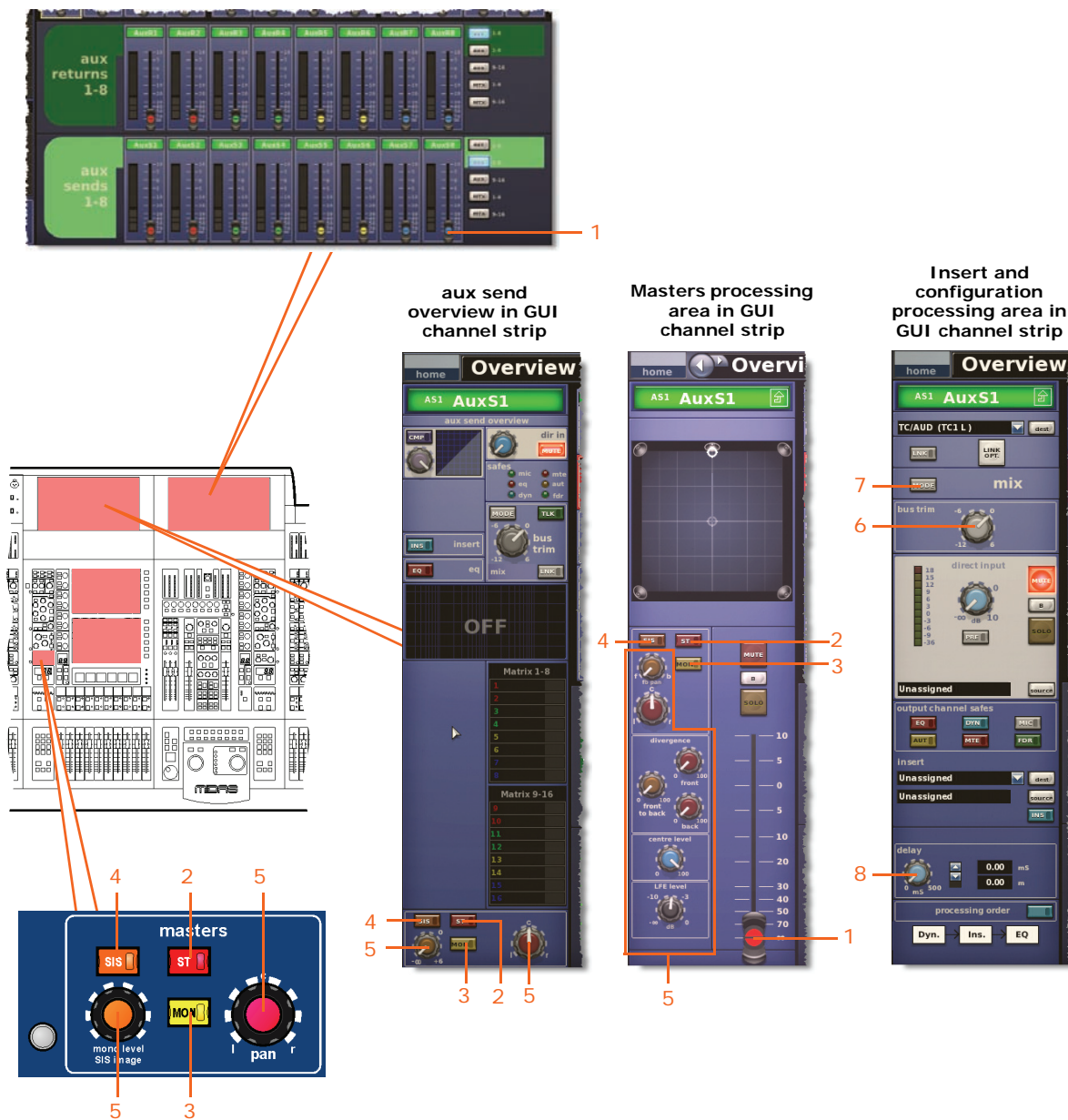

Item	Control	Parameter
1	Fader	Fader level
2	ST switch	Stereo routing
3	MON switch	Mono routing
4	SIS switch	Spatial imaging system in/out
5	Panning control knobs	Surround sound panning (includes all surround parameters)
6	bus trim control knob	Bus trim level

<i>Item</i>	<i>Control</i>	<i>Parameter</i>
7	MODE switch	Bus mode
8	delay control knob	Delay time

Returns (Aux Returns)

The return safes are selected via the **channel safes** section of the channel strip in the mix bay (control surface) or the **input channel safes** section of the configuration processing area (GUI channel strip).

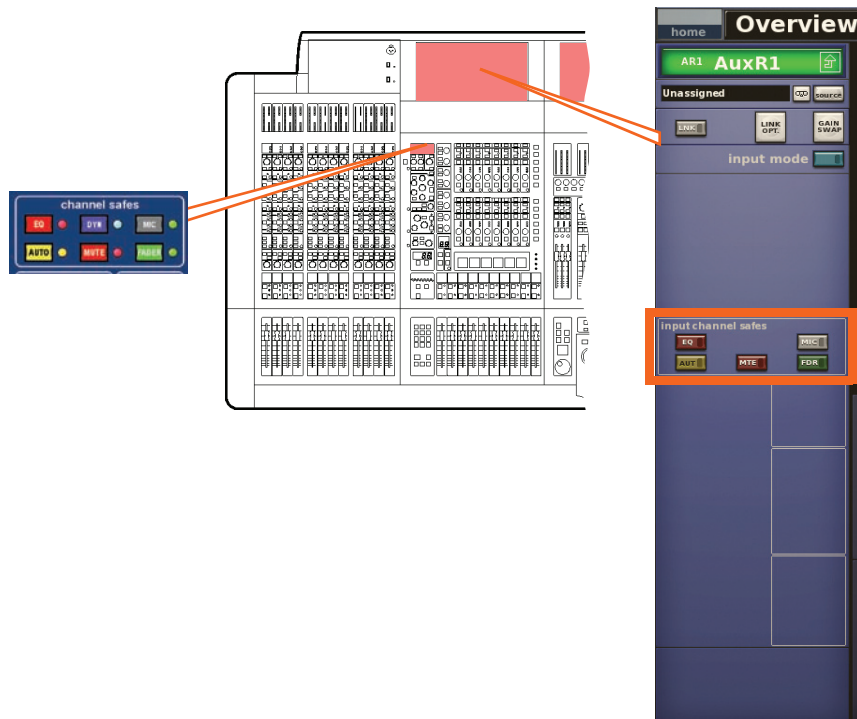

Return parameters not affected by the safes

The following return parameters are *not* affected by any of the safes.

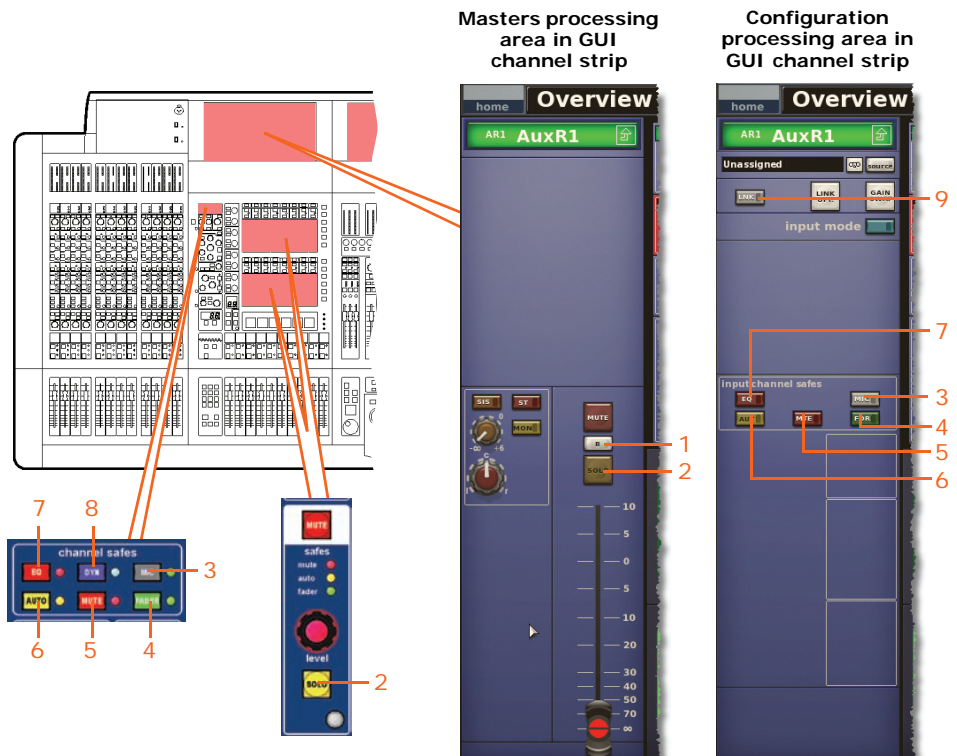

Item	Control	Parameter
1	B switch	Solo B on/off
2	SOLO switch	Solo on/off
3	MIC switch	Mic safe on/off
4	FADER/[FDR] switch	Fader safe on/off
5	MUTE/[MTE] switch	Mute safe on/off
6	AUTO/[AUT] switch	Automation safe on/off
7	EQ switch	EQ safe on/off
8	DYN switch	Dynamic safe on/off
9	LNK switch	Stereo linking on/off

EQ safe

Not applicable.

DYN (dynamic) safe

Not applicable.

MIC safe

The following diagram details the parameters in the returns protected by the **MIC** safe, which are accessible via the DL431 Mic Splitter configuration (see “Device configuration procedure” on page 90).

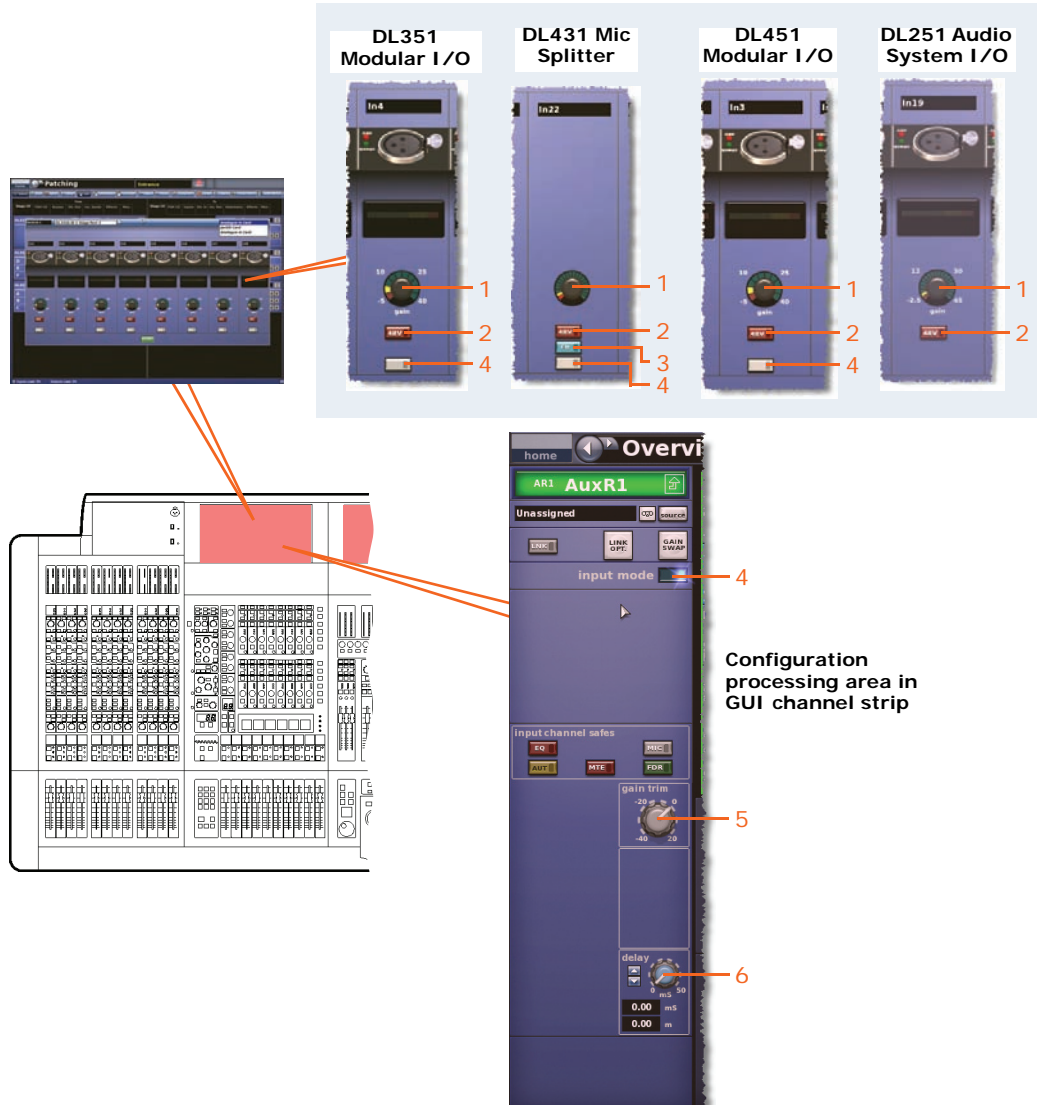

Item	Control	Parameter
1	Stage box control knob	Mic gain
2	48V switch	48V phantom gain in/out
3	Flt switch	30Hz filter ¹ in/out
4	Input zone switch	Input zone in/out
5	gain trim control knob	Digital trim
4	Input zone switch	Input zone in/out

1. Applies to tape and primary inputs.

AUTO (automation) safe

All of the return channel parameters are protected by **AUTO** (automation) safe — except, of course, for the ones unaffected by the safes (see “Return parameters not affected by the safes” on page 487).

MUTE safe

The following diagram details the parameters of the returns protected by the **MUTE** safe.

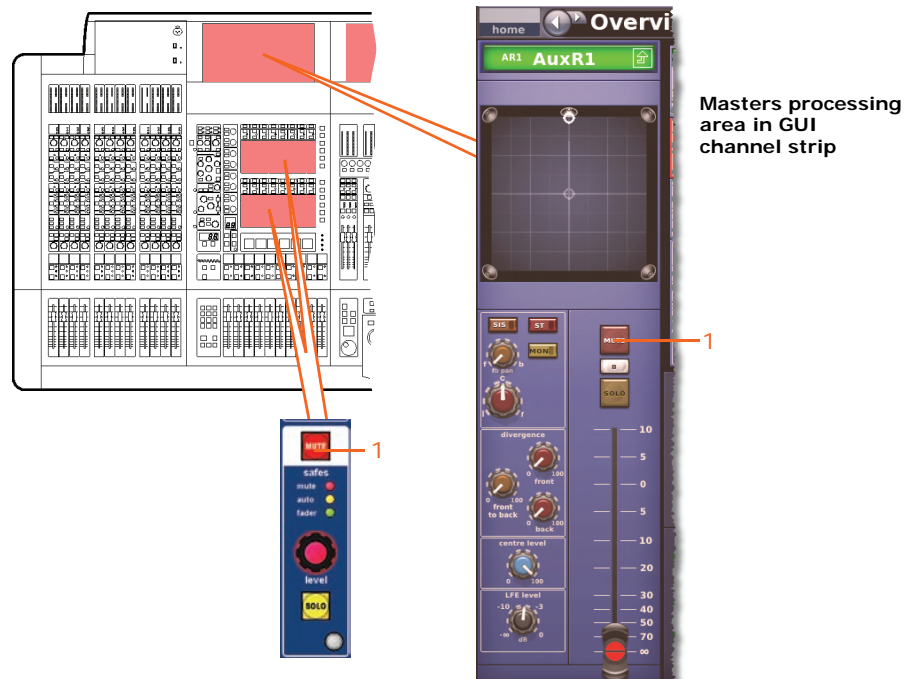

<i>Item</i>	<i>Control</i>	<i>Parameter</i>
1	MUTE switch	Mute on/off

FADER safe

The following diagram details the parameters of the returns protected by the **FADER** safe.

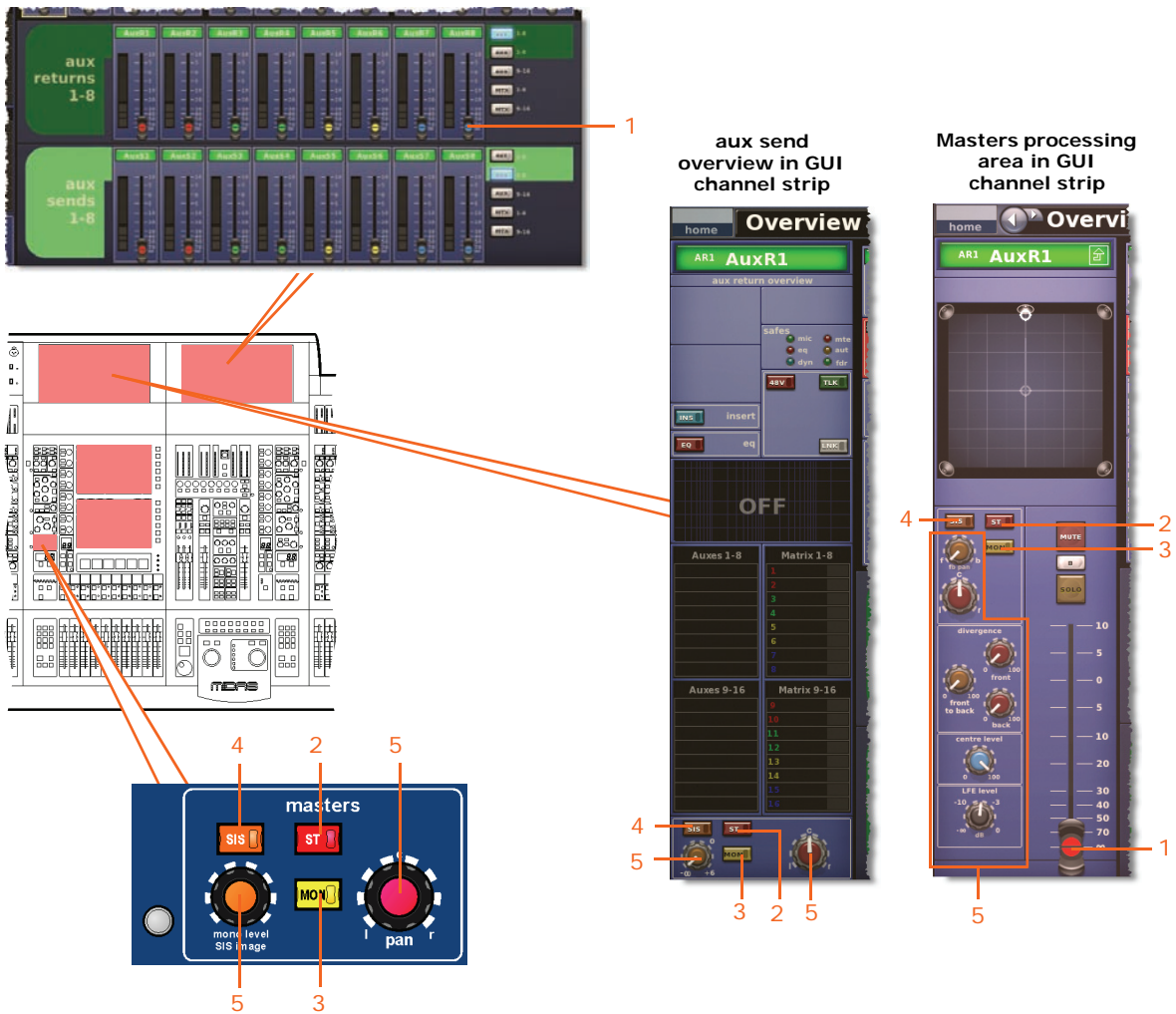

Item	Control	Parameter
1	Fader	Fader level
2	ST switch	Stereo routing
3	MON switch	Mono routing
4	SIS switch	Spatial imaging system in/out
5	Panning control knobs	Surround panning (includes all surround sound parameters)

Matrices

The matrix safes are selected via the **channel safes** section of the channel strip in the mix bay (control surface) or the **output channel safes** section of the insert and configuration processing area (GUI channel strip).

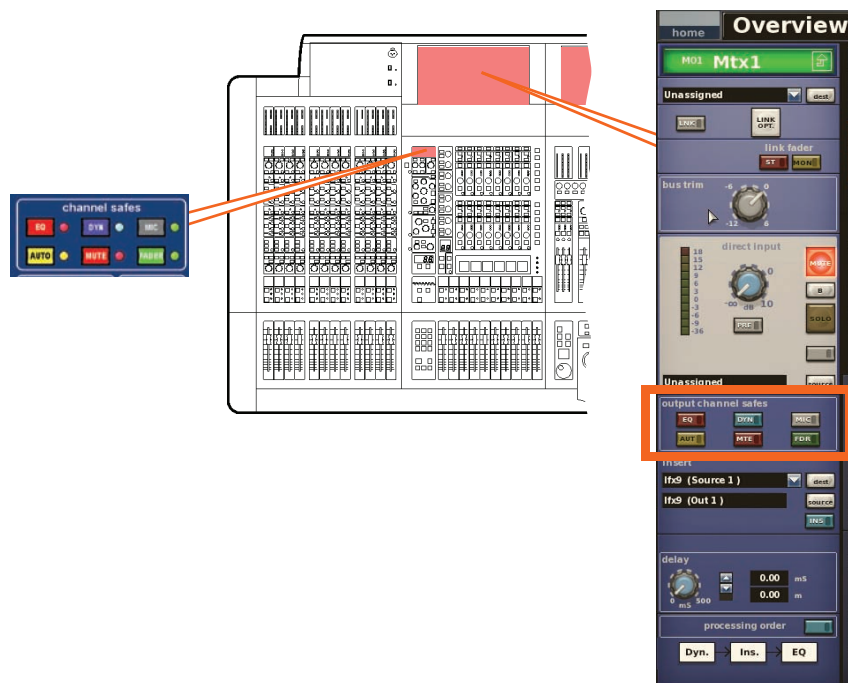

Matrix parameters not affected by the safes

The following matrix parameters are *not* affected by any of the safes.

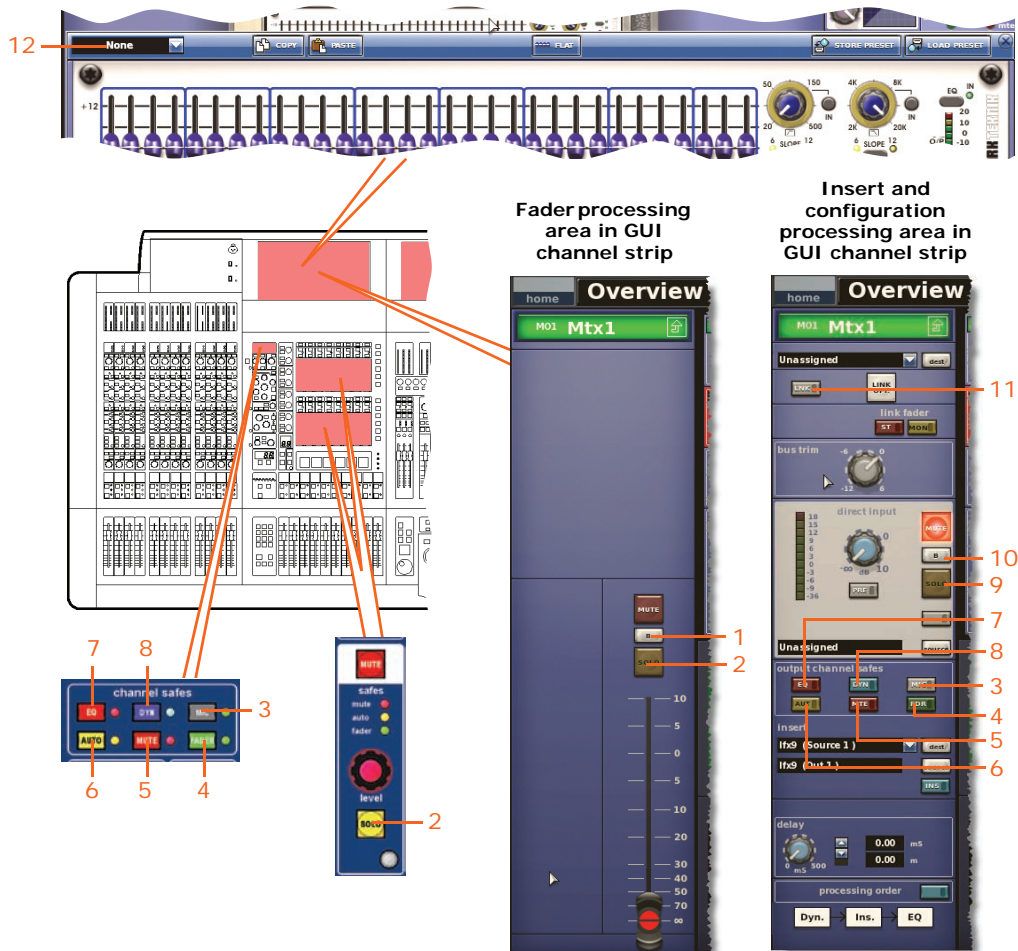

Item	Control	Parameter
1	B switch	Solo B on/off
2	SOLO switch	Solo on/off
3	MIC switch	Mic safe on/off
4	FADER/[FDR] switch	Fader safe on/off
5	MUTE/[MTE] switch	Mute safe on/off
6	AUTO/[AUT] switch	Automation safe on/off
7	EQ switch	EQ safe on/off
8	DYN switch	Dynamic safe on/off
9	SOLO switch	Direct input solo on/off
10	B switch	Direct input solo B on/off
11	LNK switch	Stereo linking on/off
12	Field	GEQ assignment

EQ safe

The following diagram details the matrix parameters protected by the **EQ safe**.

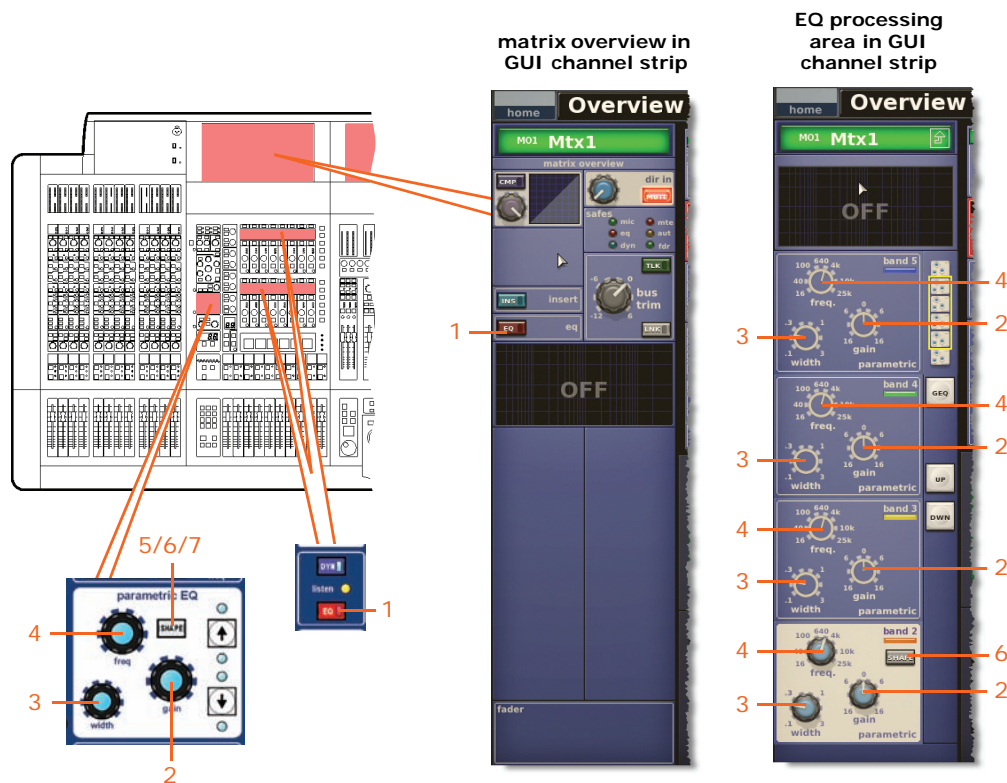

Item	Control	Parameter
1	EQ switch	EQ on/off
2	gain control knob	EQ gain level
3	width control knob	EQ width
4	freq control knob	EQ frequency
5*	SHAPE switch	Selects band 1 shelving modes: bell, warm, high pass 6dB or high pass 12dB
6	SHAPE switch	Selects band 2 shelving modes: bell or high pass 24dB
7*	SHAPE switch	Selects band 6 shelving modes: bell, soft, low pass 6dB or low pass 12dB

* Not shown in diagram.

Note: Although bands 1 and 6 are not shown above, the items in the table also apply. Both bands have items 2, 3 and 4. Additionally, band 1 also has item 5, and band 6 also has item 7.

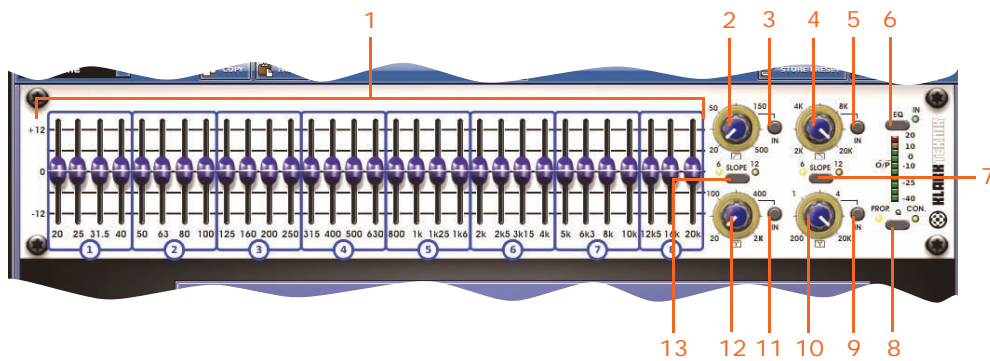

<i>Item</i>	<i>Control</i>	<i>Parameter</i>
1	31 faders	Fader positions
2	High pass filter control knob	High pass filter cut off frequency
3	IN switch	High pass filter in/out
4	Low pass filter control knob	Low pass filter cut off frequency
5	IN switch	Low pass filter in/out
6	EQ switch	EQ in/out
7	SLOPE switch	Selects low pass filter as 6dB or 12dB
8	Q switch	Selects Q mode as proportional (PROP.) or constant (CON.)
9	IN switch	Switches 200Hz - 20kHz notch filter in/out
10	Notch filter control knob	200Hz - 20kHz notch filter frequency
11	IN switch	Switches 20Hz - 2kHz notch filter in/out
12	Notch filter control knob	20Hz - 2kHz notch filter frequency
13	SLOPE switch	Selects high pass filter as 6dB or 12dB

DYN (dynamic) safe

The following diagram details the matrix parameters protected by the **DYN** safe. Only the corrective compressor is shown, but this is typically the same for the other compressor modes (adaptive, creative, vintage and shimmer).

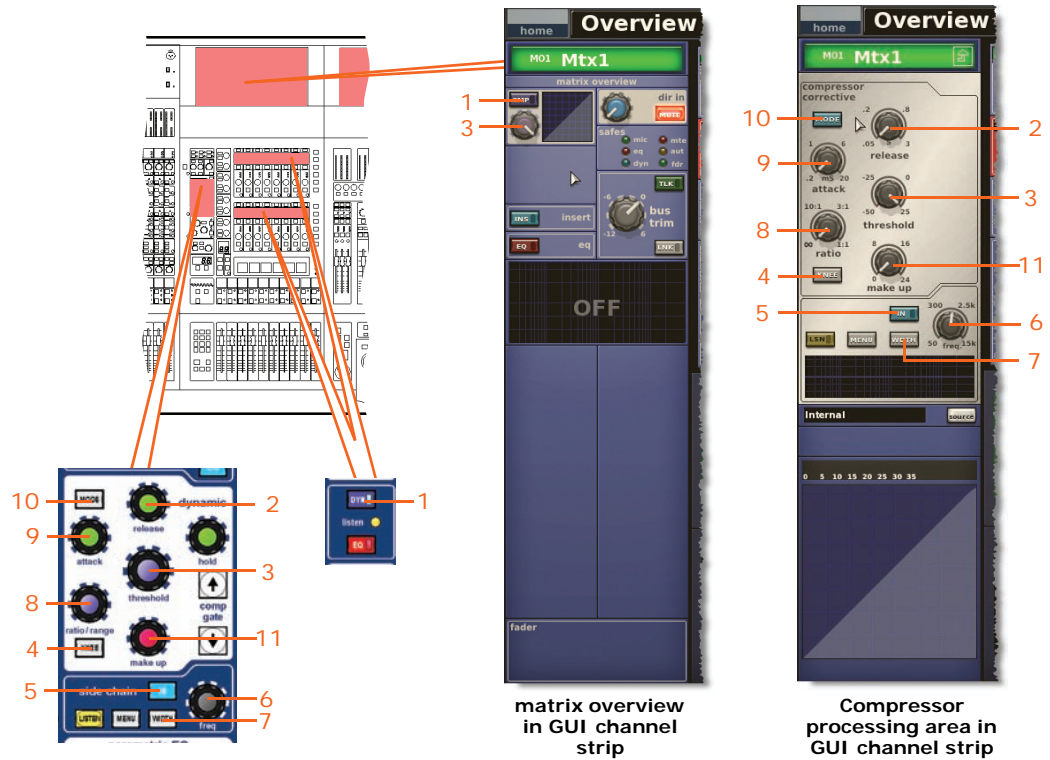

Item	Control	Parameter
1	DYN /[CMP] switch	Compressor on/off
2	release control knob	Compressor release
3	threshold control knob	Compressor threshold
4	KNEE pushbutton	Compressor knee selector: hard, medium and soft
5	IN switch	Compressor sidechain in/out
6	freq control knob	Compressor sidechain frequency
7	WIDTH pushbutton	Compressor sidechain width selector: 2 Oct, 1 Oct and 0.3 Oct
8	ratio/range /[ratio] control knob	Compressor ratio
9	attack control knob	Compressor attack
10	MODE pushbutton	Compressor mode selector — corrective, adaptive, creative, vintage or shimmer
11	make up control knob	Compressor gain

MIC safe

The following diagram details the matrix parameters protected by the **MIC** (configuration) safe.

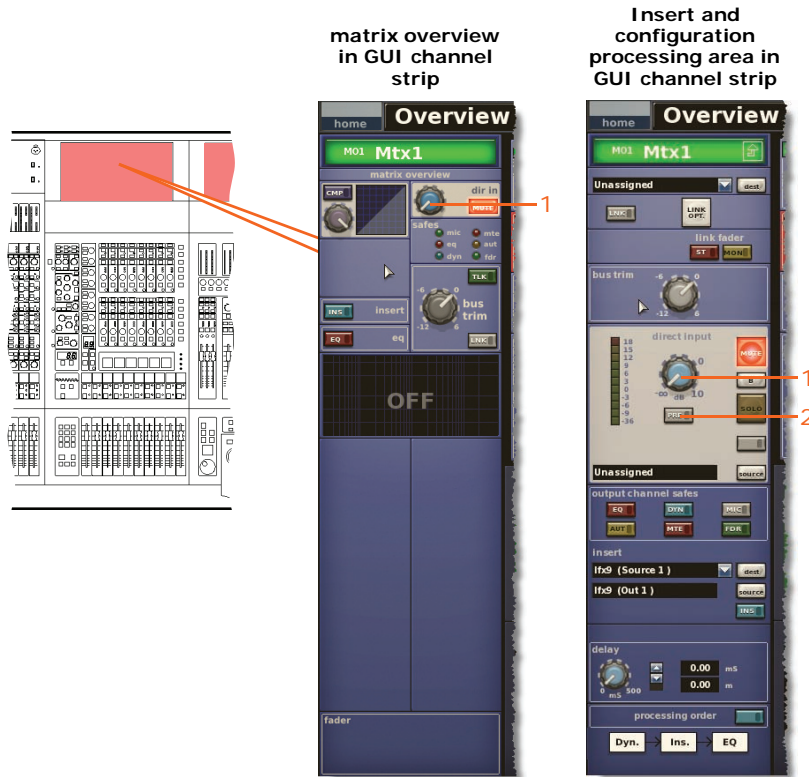

Item	Control	Parameter
1	Control knob	Direct input level
2	PRE switch	Direct input pre- in/out

AUTO (automation) safe

All of the matrix channel parameters are protected by **AUTO** (automation) safe — except, of course, for the ones unaffected by the safes (see “Matrix parameters not affected by the safes” on page 492).

MUTE safe

The following diagram details the matrix parameters protected by the **MUTE** safe.

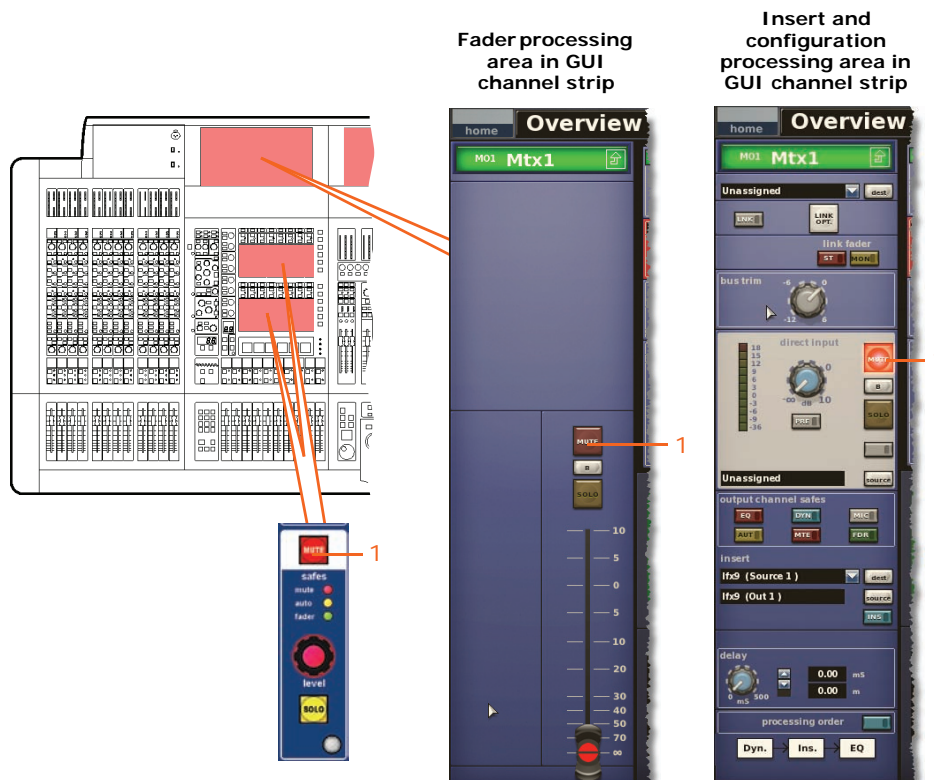

<i>Item</i>	<i>Control</i>	<i>Parameter</i>
1	MUTE switch	Mute on/off
2	MUTE switch	Direct input mute on/off

FADER safe

The following diagram details the matrix parameters protected by the **FADER** safe.

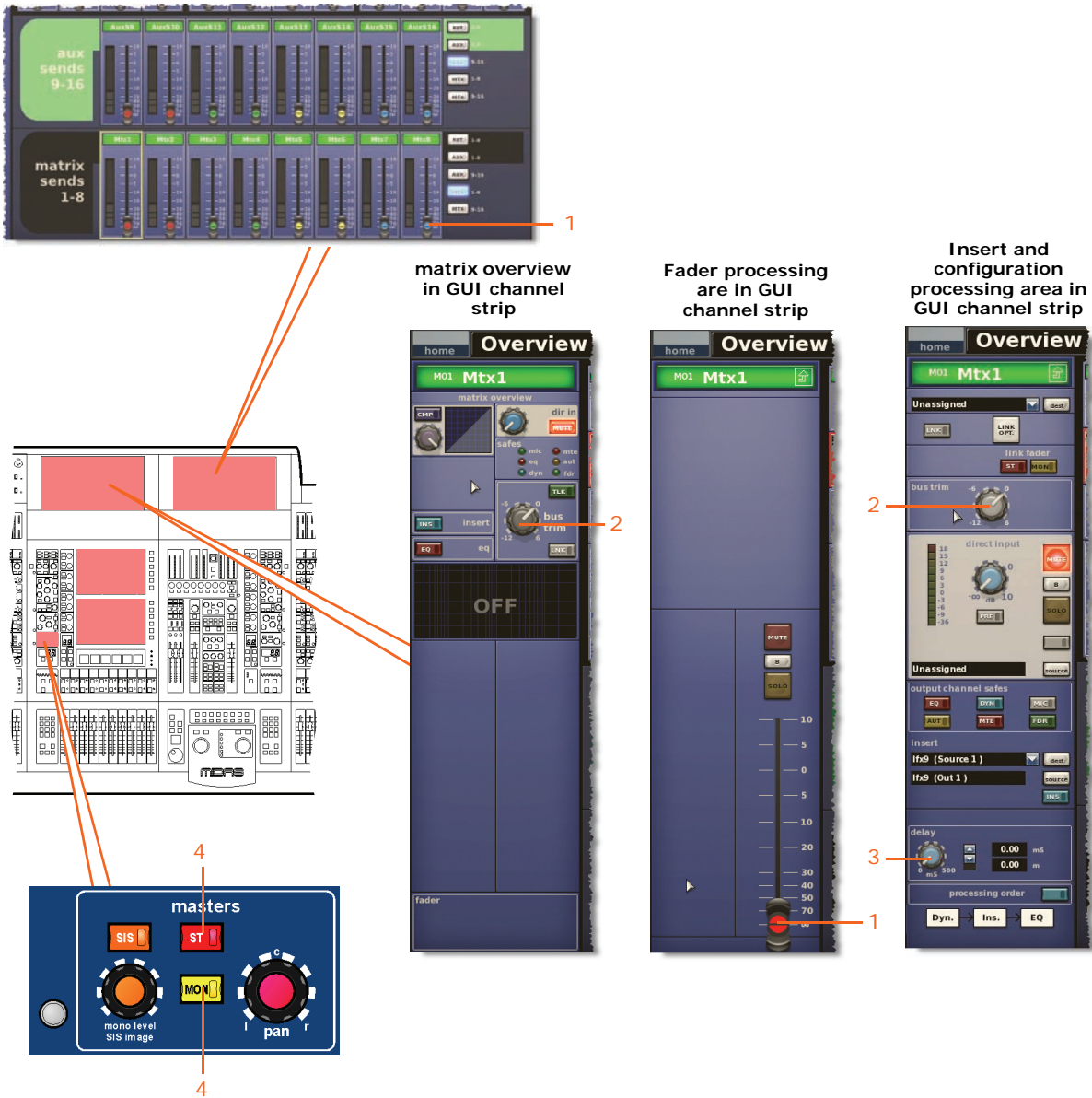

Item	Control(s)	Parameter
1	Fader	Fader level
2	bus trim control knob	Bus trim level
3	delay control knob	Delay time
4	ST switch, MON switch	Linking to stereo/mono master fader switch

Masters

The master safes are selected via the **channel safes** section of the channel strip in the mix bay (control surface) or the **output channel safes** section of insert and configuration processing area (GUI channel strip).

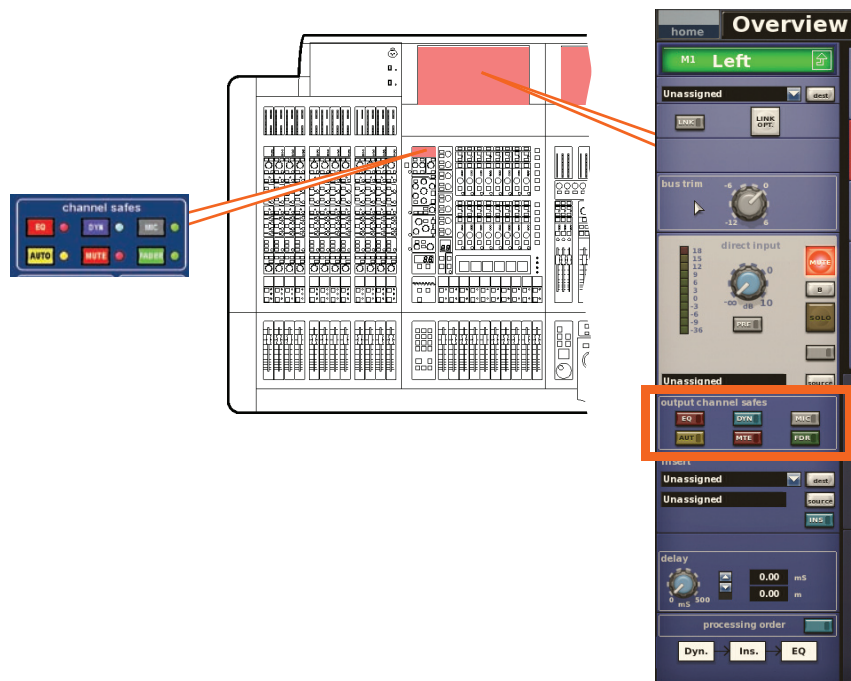

Master parameters not affected by the safes

The following shows you which master parameters are *not* affected by each safe.

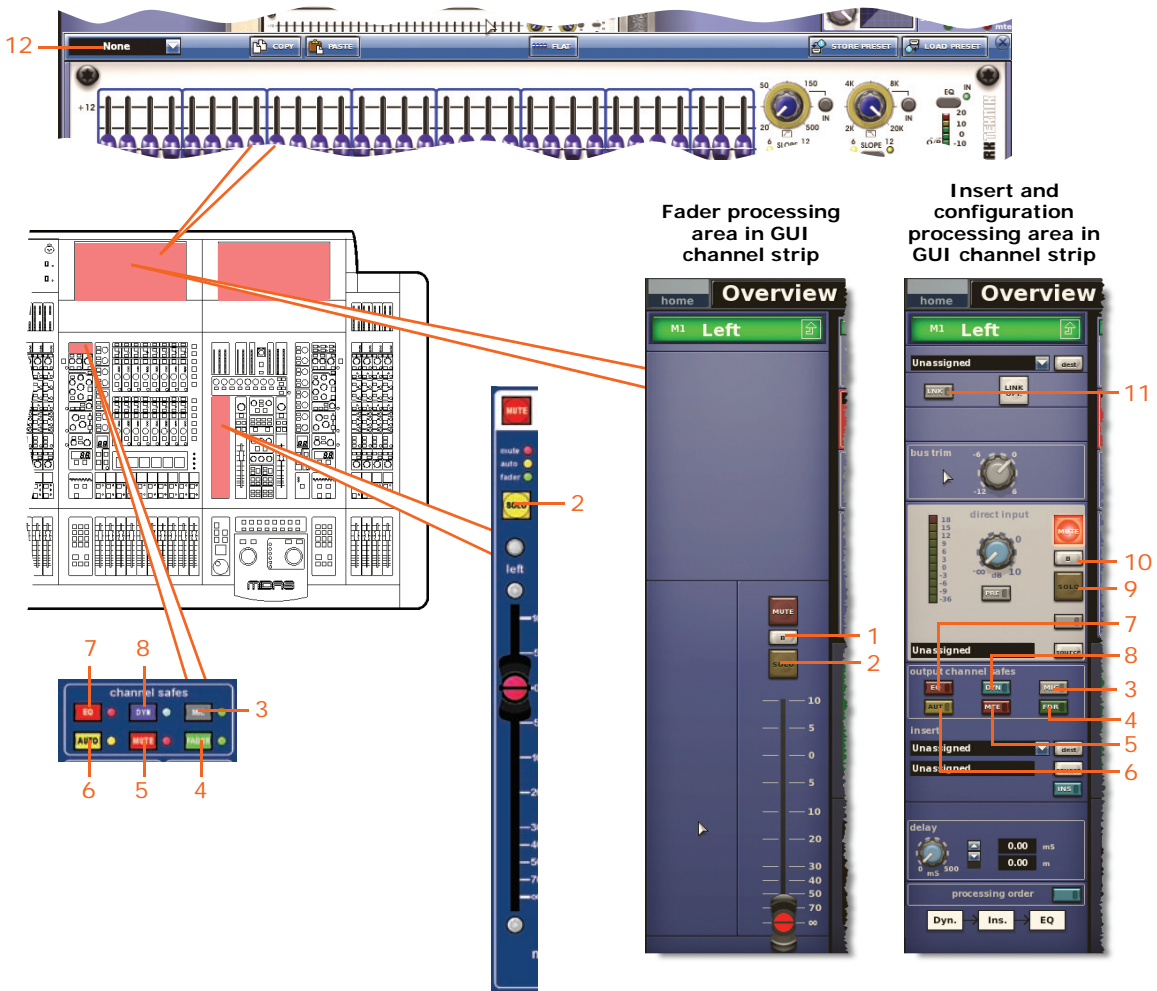

Item	Control	Parameter
1	B switch	Solo B on/off
2	SOLO switch	Solo on/off
3	MIC switch	Mic safe on/off
4	FADER/[FDR] switch	Fader safe on/off
5	MUTE/[MTE] switch	Mute safe on/off
6	AUTO/[AUT] switch	Automation safe on/off
7	EQ switch	EQ safe on/off
8	DYN switch	Dynamic safe on/off
9	SOLO switch	Direct input solo on/off
10	B switch	Direct input solo B on/off
11	LNK switch	Stereo linking
12	Field	GEQ assignment

EQ safe

The following diagram details the master parameters protected by the **EQ safe**.

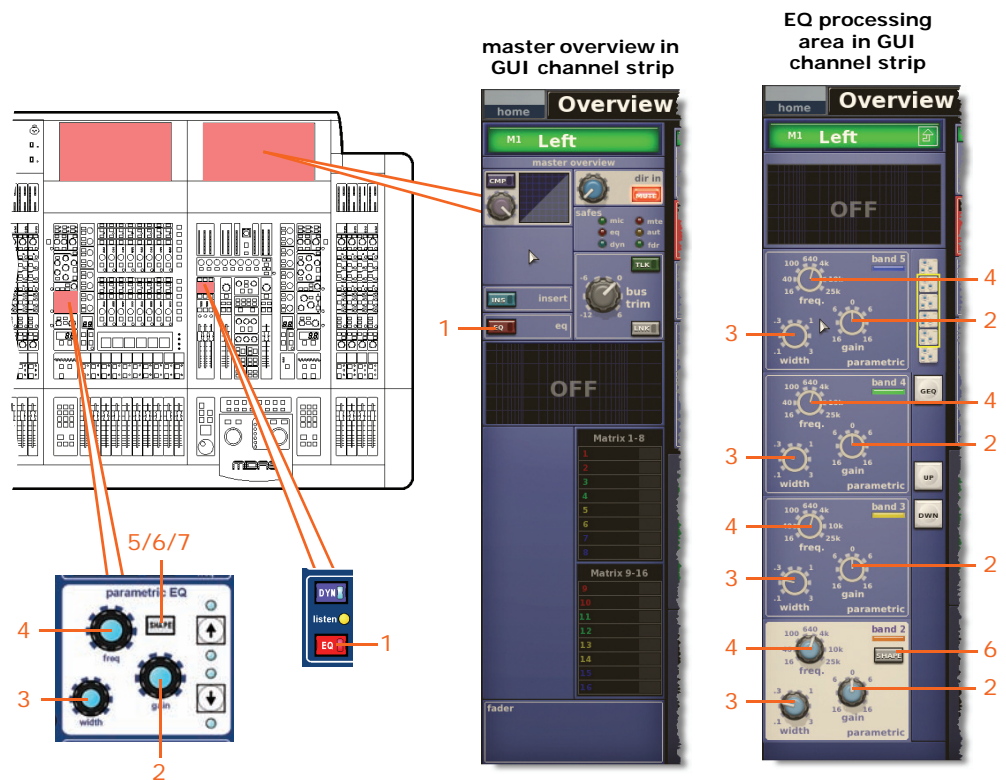

Item	Control	Parameter
1	EQ switch	EQ on/off
2	gain control knob	EQ gain level
3	width control knob	EQ width
4	freq control knob	EQ frequency
5*	SHAPE switch	Selects band 6 shelving modes: bell, soft, low pass 6dB or low pass 12dB
6*	SHAPE switch	Selects band 1 shelving modes: bell, warm, high pass 6dB or high pass 12dB
7	SHAPE switch	Selects band 2 shelving modes: bell or high pass 24dB

* Not shown in diagram.

Note: Although bands 1 and 6 are not shown above, the items in the table also apply. Both bands have items 2, 3 and 4. Additionally, band 1 has item 6, and band 6 has item 5.

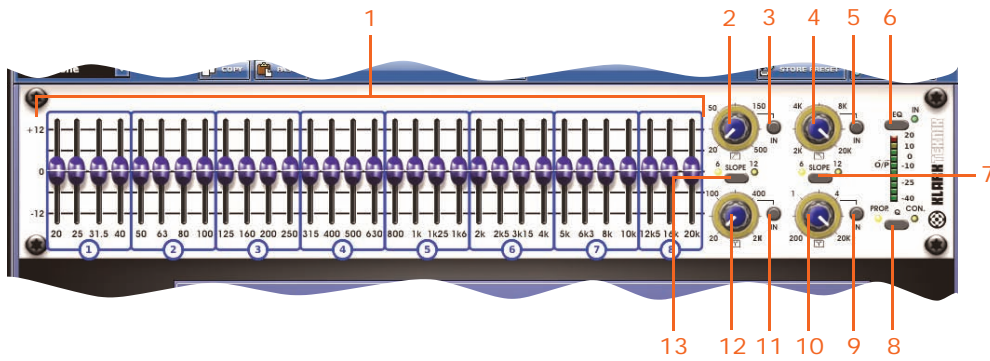

<i>Item</i>	<i>Control</i>	<i>Parameter</i>
1	31 faders	Fader positions
2	High pass filter control knob	High pass filter cut off frequency
3	IN switch	High pass filter in/out
4	Low pass filter control knob	Low pass filter cut off frequency
5	IN switch	Low pass filter in/out
6	EQ switch	EQ in/out
7	SLOPE switch	Selects low pass filter as 6dB or 12dB
8	Q switch	Selects Q mode as proportional (PROP.) or constant (CON.)
9	IN switch	Switches 200Hz - 20kHz notch filter in/out
10	Notch filter control knob	200Hz - 20kHz notch filter frequency
11	IN switch	Switches 20Hz - 2kHz notch filter in/out
12	Notch filter control knob	20Hz - 2kHz notch filter frequency
13	SLOPE switch	Selects high pass filter as 6dB or 12dB

DYN (dynamic) safe

The following diagram details the master parameters protected by the **DYN** safe. Only the corrective compressor is shown, but this is typically the same for the other compressor modes (adaptive, creative, vintage and shimmer).

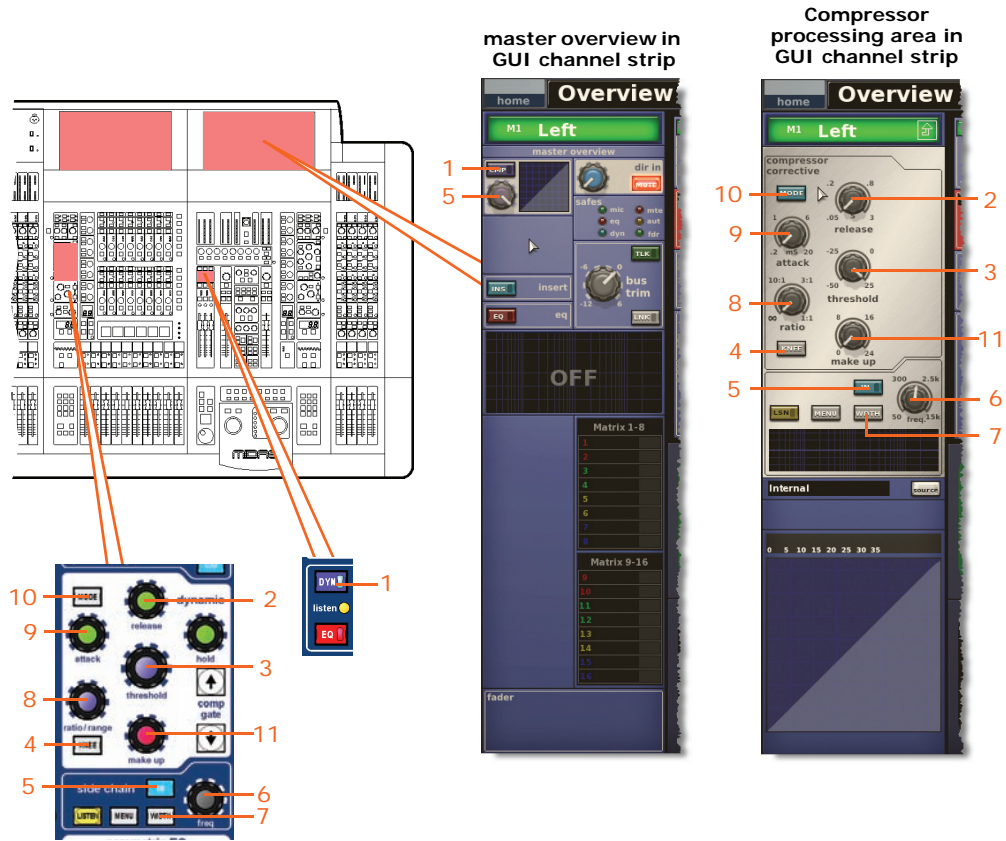

Item	Control	Parameter
1	CMP switch	Compressor on/off
2	release control knob	Compressor release
3	threshold control knob	Compressor threshold
4	KNEE pushbutton	Compressor knee selector: hard, medium and soft
5	IN switch	Compressor sidechain in/out
6	freq control knob	Compressor sidechain frequency
7	WIDTH pushbutton	Compressor sidechain width: 2 Oct, 1 Oct or 0.3 Oct
8	ratio/range/[ratio] control knob	Compressor ratio
9	attack control knob	Compressor attack
10	MODE pushbutton	Compressor mode — corrective, adaptive, creative, vintage or shimmer
11	make up control knob	Compressor gain

MIC safe

The following diagram details the master parameters protected by the **MIC** (configuration) safe.

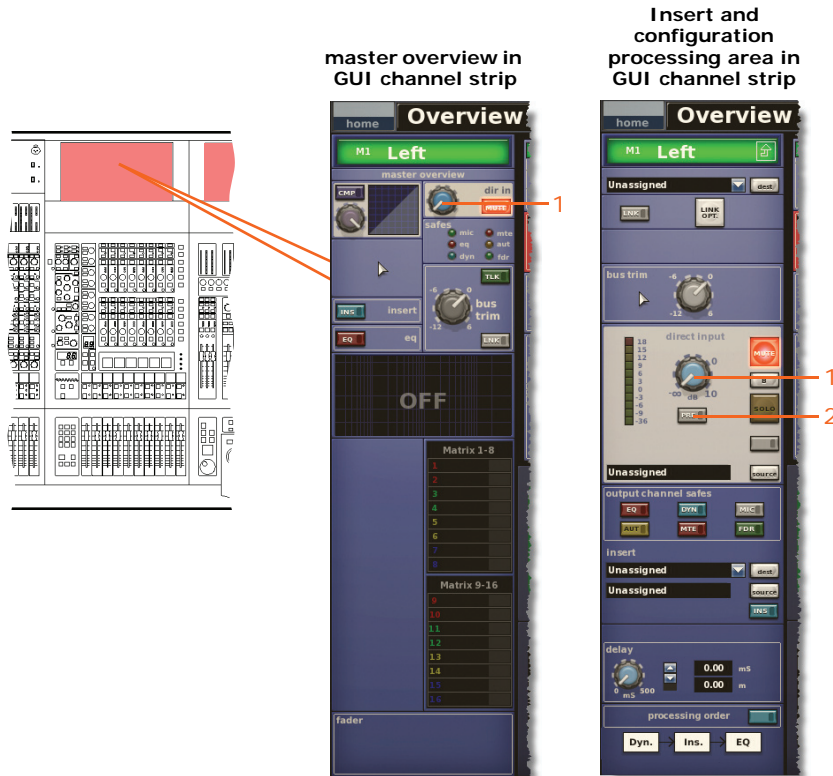

Item	Control	Parameter
1	Control knob	Direct input level
2	PRE switch	Direct input pre- in/out

AUTO (automation) safe

All of the master channel parameters are protected by **AUTO** (automation) safe — except, of course, for the ones unaffected by the safes (see “Aux parameters not affected by the safes” on page 479).

MUTE safe

The following diagram details the master parameters protected by the **MUTE** safe.

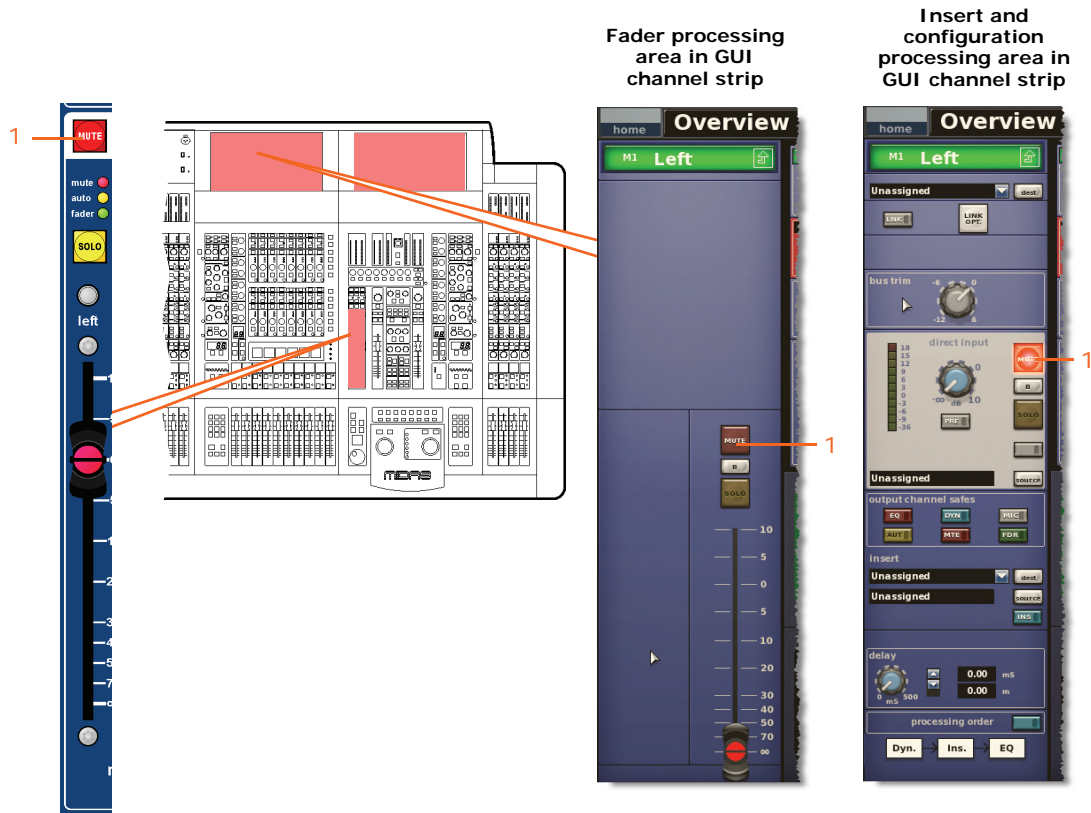

<i>Item</i>	<i>Control</i>	<i>Parameter</i>
1	MUTE switch	Mute on/off
2	MUTE switch	Direct input mute on/off

FADER safe

The following diagram details the master parameters protected by the **FADER** safe.

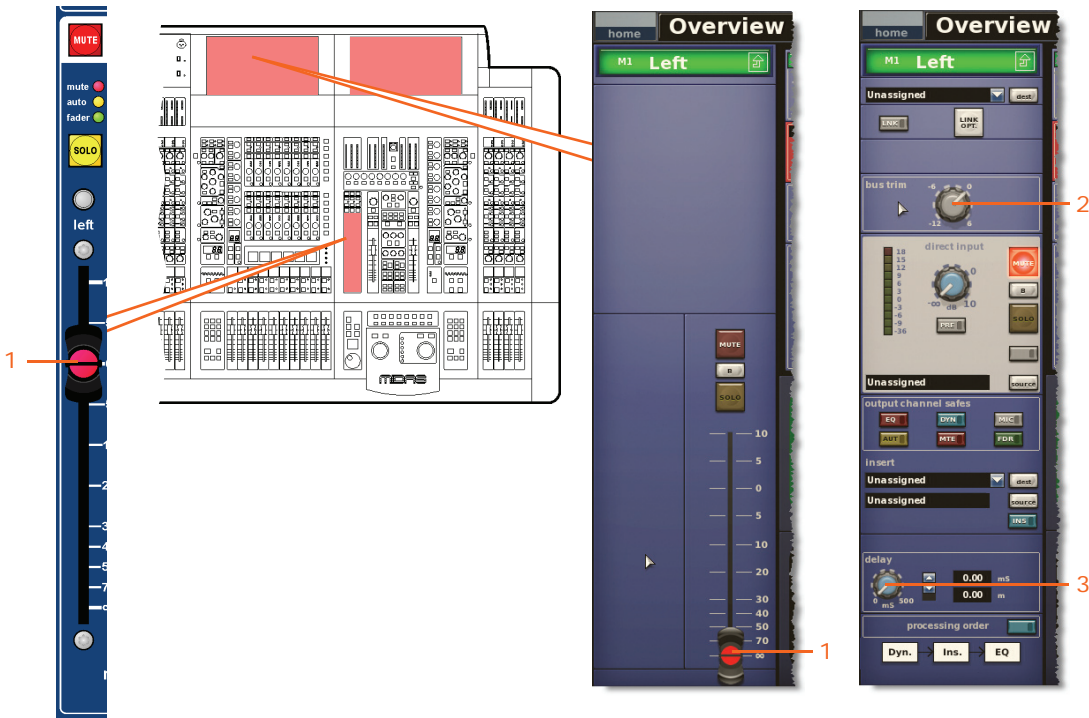

<i>Item</i>	<i>Control</i>	<i>Parameter</i>
1	Fader	Fader level
2	bus trim control knob	Bus trim level
3	delay control knob	Delay time

Groups

The group safes — mute (MTE) and fader (FDR) — are selected via the **VCA Groups** screen of the GUI (shown below).

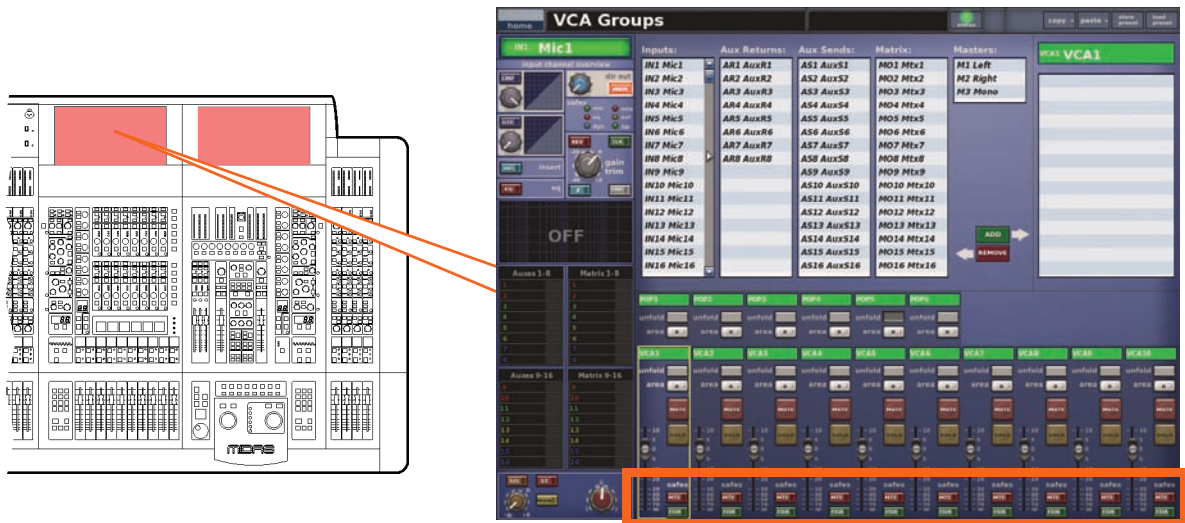

EQ safe

Not applicable.

Dynamic safe

Not applicable.

Mic safe

Not applicable.

Automation safe

The following diagram shows the parameters of the VCA groups protected by the **MTE** (mute) safe.

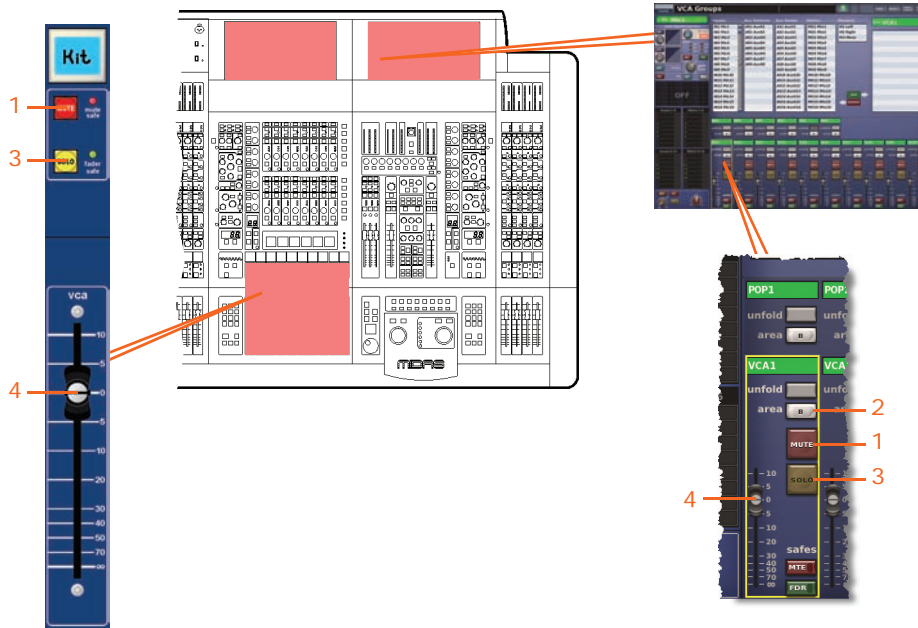

<i>Item</i>	<i>Control</i>	<i>Parameter</i>
1	MUTE switch	Mute on/off
2	B switch	Solo B on/off
3	SOLO switch	Solo on/off
4	Fader	Fader level

Mute (MTE) safe

The following diagram shows the parameters of the VCA groups protected by the **MTE** (mute) safe.

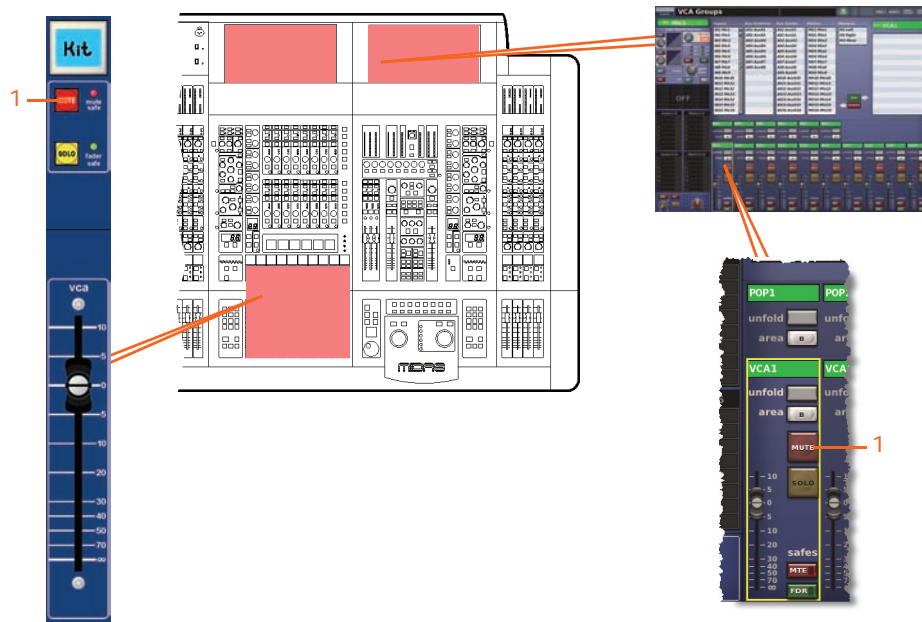

<i>Item</i>	<i>Control</i>	<i>Parameter</i>
1	MUTE switch	Mute on/off

Fader (FDR) safe

The following diagram shows the parameters of the VCA groups protected by the **FDR** (fader) safe.

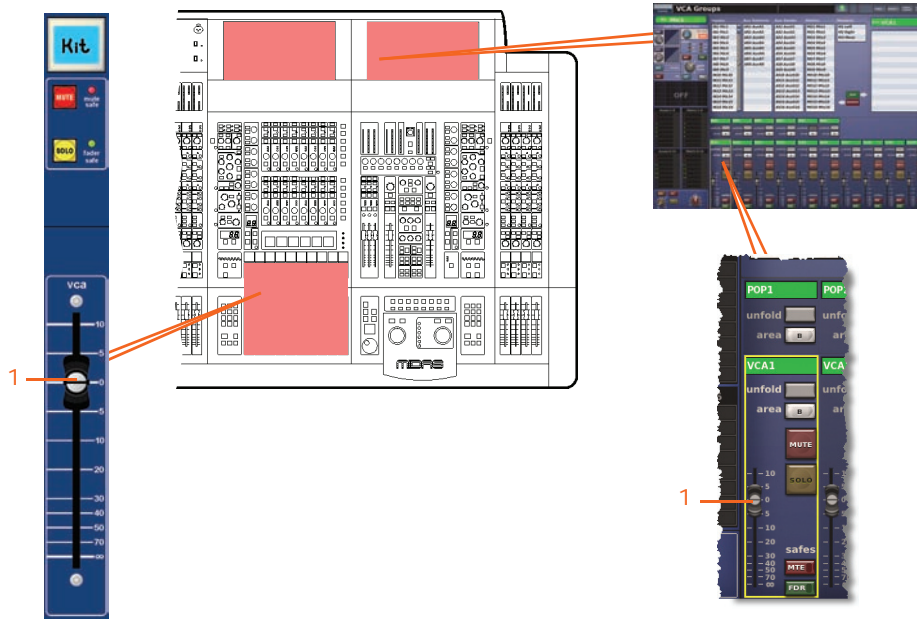

<i>Item</i>	<i>Control</i>	<i>Parameter</i>
1	Fader	Fader level

Appendix N: Parameters Affected By Copy And Paste

This appendix shows the input and output channel parameters affected by copy and paste operations, which are selected via the copy and paste buttons on the GUI (see "Using copy and paste" on page 118).

The structure of this appendix is intended to follow the way that copy and paste operates, that is, by channel or processing area.

Note: Some of the GUI displays in this appendix may look slightly different to the ones on the PRO Series Control Centre you are using, as they may be taken from a different type of PRO Series Live Audio System. For example, the PRO3 doesn't have a **Matrix 9 - 16** section in the GUI channel strip. However, all of the parameters affected by copy and paste still apply.

Overview

The following table provides a quick reference for finding the copy and paste parameters per channel in this appendix.

Control area	Inputs	Auxes	Returns	Matrices	Masters
Configuration	"Configuration" on page 512	"Configuration" on page 520	"Configuration" on page 526	"Configuration" on page 529	"Configuration" on page 534
Compressor	"Compressor" on page 514	"Compressor" on page 521	N/A	"Compressor" on page 530	"Compressor" on page 535
Gate	"Gate" on page 516	N/A	N/A	N/A	N/A
EQ (GEQ)	"EQ" on page 517	"EQ (GEQ)" on page 522	N/A	"EQ (GEQ)" on page 531	"EQ (GEQ)" on page 536
Bus sends	"Bus sends" on page 518	"Bus sends" on page 524	"Bus sends" on page 527	N/A	N/A
Master routing /fader section	"Master routing" on page 519	"Master routing" on page 525	"Master routing" on page 528	"Fader section" on page 533	"Master routing" on page 538

Inputs

This section shows you which input channel parameters are affected by copy and paste.

Configuration

The following diagram shows the parameters of the input configuration section affected by copy and paste.

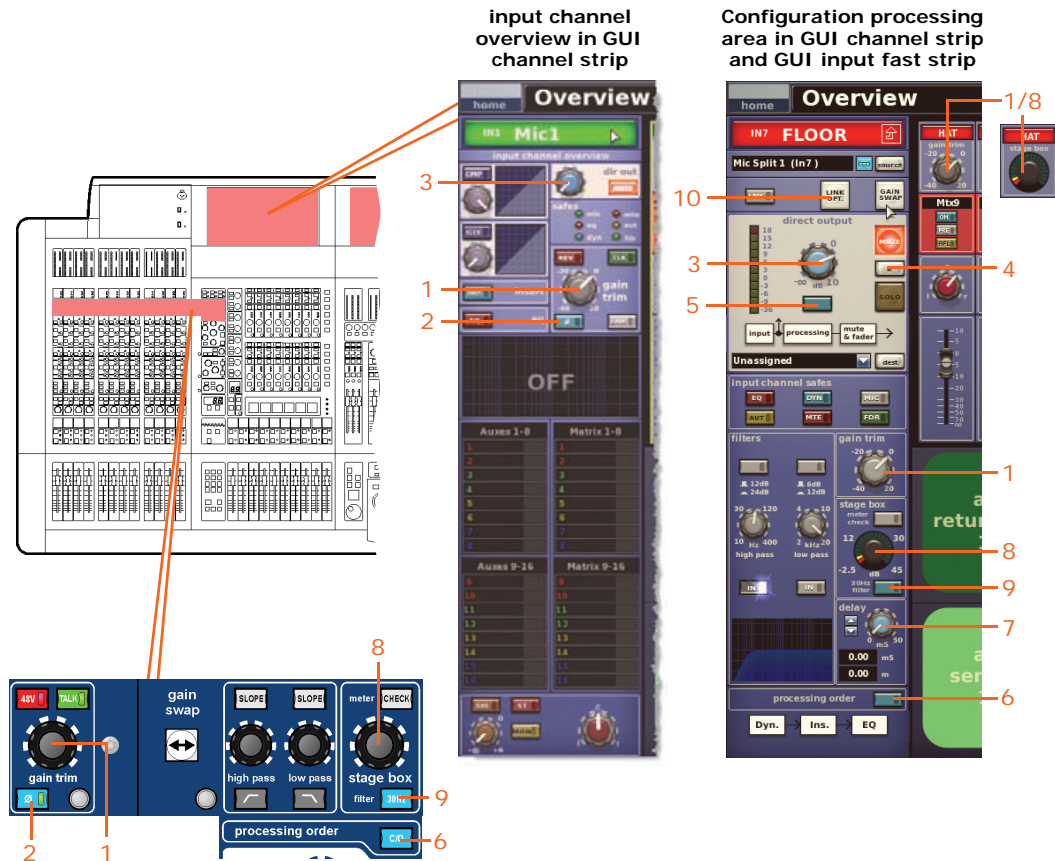

Item	Control	Parameter
1	gain trim control knob	Digital trim
2	Ø switch	Phase invert on/off switch
3	Control knob	Direct output level
4	B switch	Direct output solo B on/off
5	Pushbutton	Direct output tap-off point: "Post-fade and mute", "Pre-mute, pre-processing" and "Pre-mute, post-processing"
6	C/O switch	Order of processing: Dyn. → Ins. → EQ or EQ → Ins. → Dyn.
7	delay control knob	Delay time
8	stage box control knob	Gain of remote amplifier knob

<i>Item</i>	<i>Control</i>	<i>Parameter</i>
9	30Hz filter switch	30Hz filter in/out
10	LINK OPT. pushbutton	Stereo linking options

Compressor

This section shows the compression parameters of the input dynamics section affected by copy and paste.

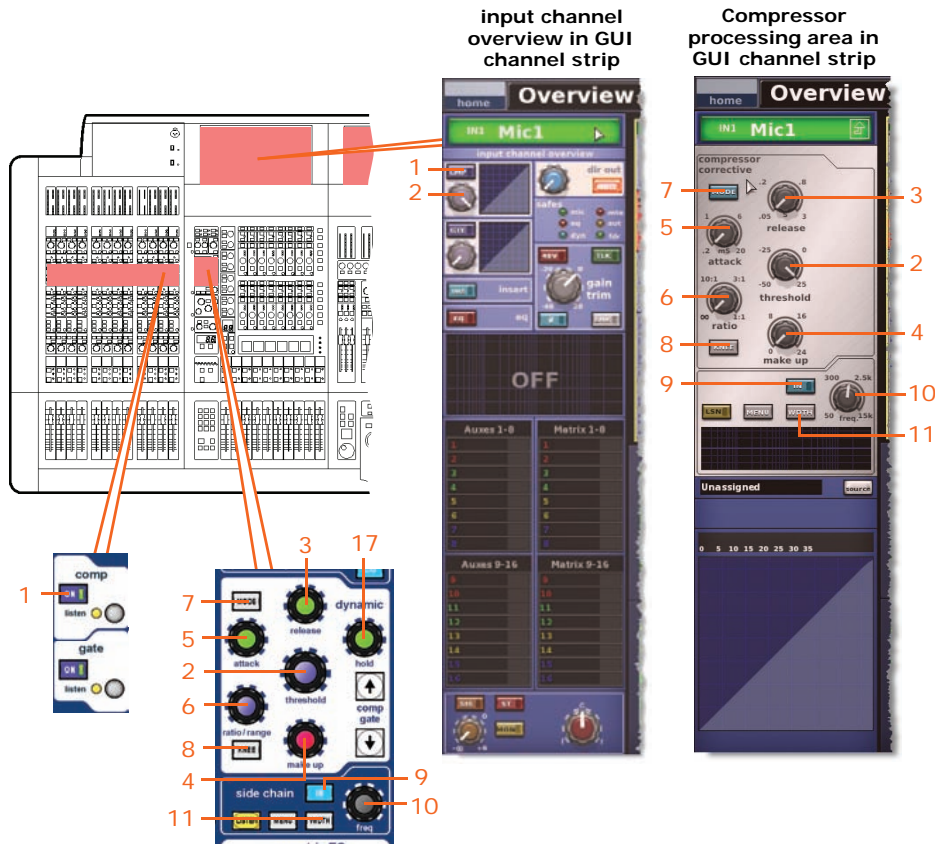

Note: Only the corrective compressor is shown above, but this is typically the same for the other compressor modes (adaptive, creative and vintage).

Item	Control	Parameter
1	ON/[CMP] switch	Compressor on/off
2	threshold control knob	Compressor threshold
3	release control knob	Compressor release
4	make up control knob	Compressor make up gain
5	attack control knob	Compressor attack
6	ratio/range/[ratio] control knob	Compressor ratio
7	MODE pushbutton	Compressor mode selector: corrective (shown above), adaptive, creative and vintage
8	KNEE pushbutton	Compressor knee: hard, medium or soft
9	IN switch	Compressor sidechain in/out

<i>Item</i>	<i>Control</i>	<i>Parameter</i>
10	freq control knob	Compressor sidechain frequency
11	WIDTH pushbutton	Compressor sidechain width: 2 Oct, 1 Oct or 0.3 Oct

Gate

This section shows the gate parameters of the input dynamics section affected by copy and paste.

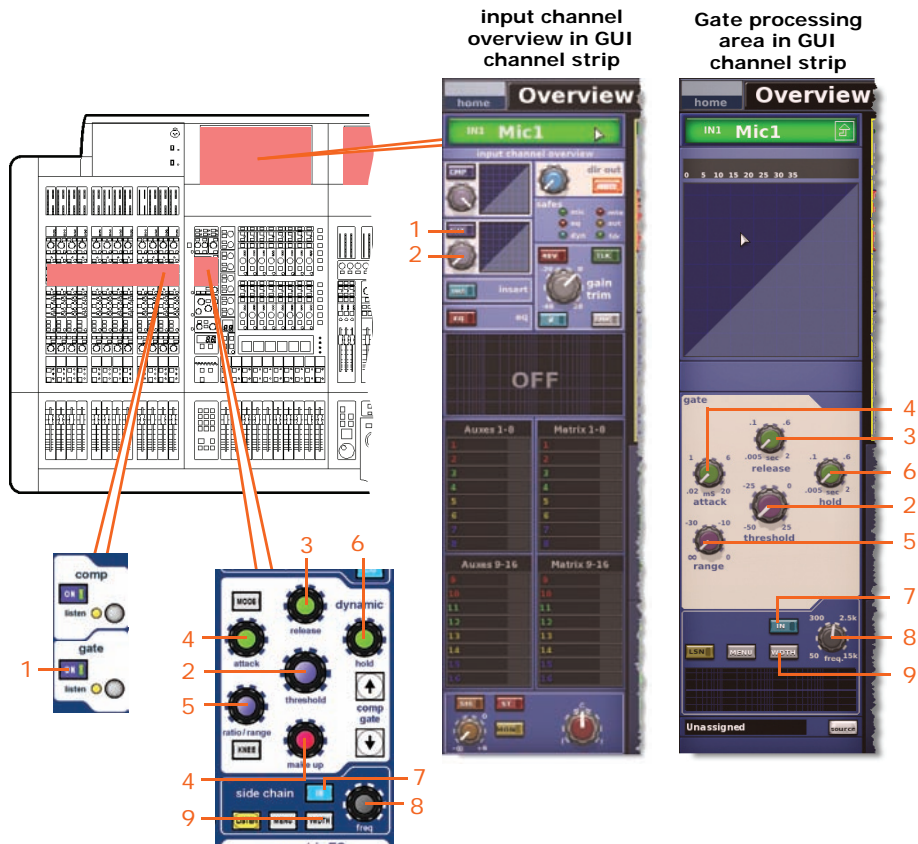

Item	Control	Parameter
1	ON/[GTE] switch	Gate on/off
2	threshold control knob	Gate threshold
3	release control knob	Gate release
4	attack control knob	Gate attack
5	ratio/range/[range] control knob	Gate range
6	hold control knob	Gate hold
7	IN switch	Gate sidechain in/out
8	freq control knob	Gate sidechain frequency
9	WIDTH pushbutton	Gate sidechain width: 2 Oct, 1 Oct or 0.3 Oct

EQ

This section shows the parameters of the input EQ section affected by copy and paste.

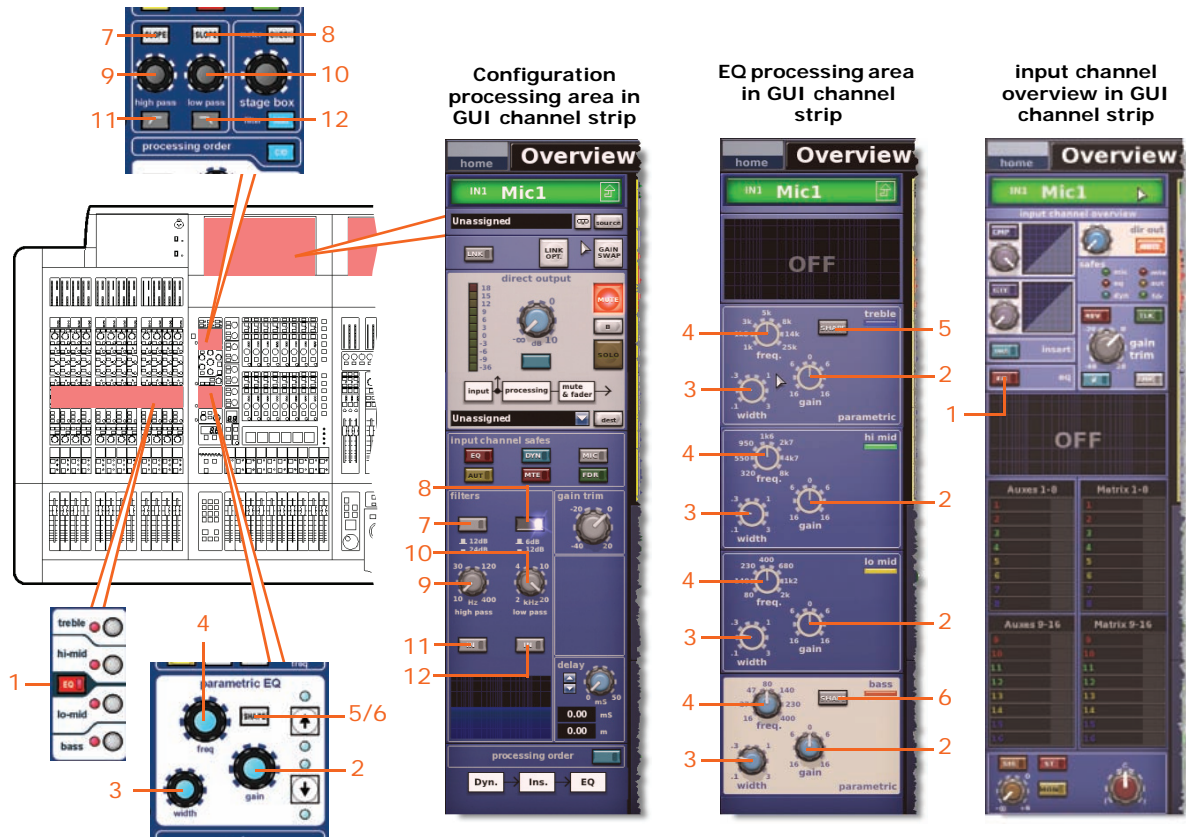

Item	Control	Parameter
1	EQ switch	EQ on/off
2	gain control knob	EQ gain level
3	width control knob	EQ width
4	freq control knob	EQ frequency
5	SHAPE switch	Treble shelving mode: peaking, bright, classic or soft
6	SHAPE switch	Bass shelving mode: peaking, deep, classic or warm
7	SLOPE pushbutton	High pass filter slope 12dB or 24dB
8	SLOPE pushbutton	Low pass filter slope 6dB or 12dB
9	high pass control knob	High pass filter frequency
10	low pass control knob	Low pass filter frequency
11	[IN] switch	High pass filter in/out
12	[IN] switch	Low pass filter in/out

Bus sends

This section shows the parameters of the input mix sections affected by copy and paste.

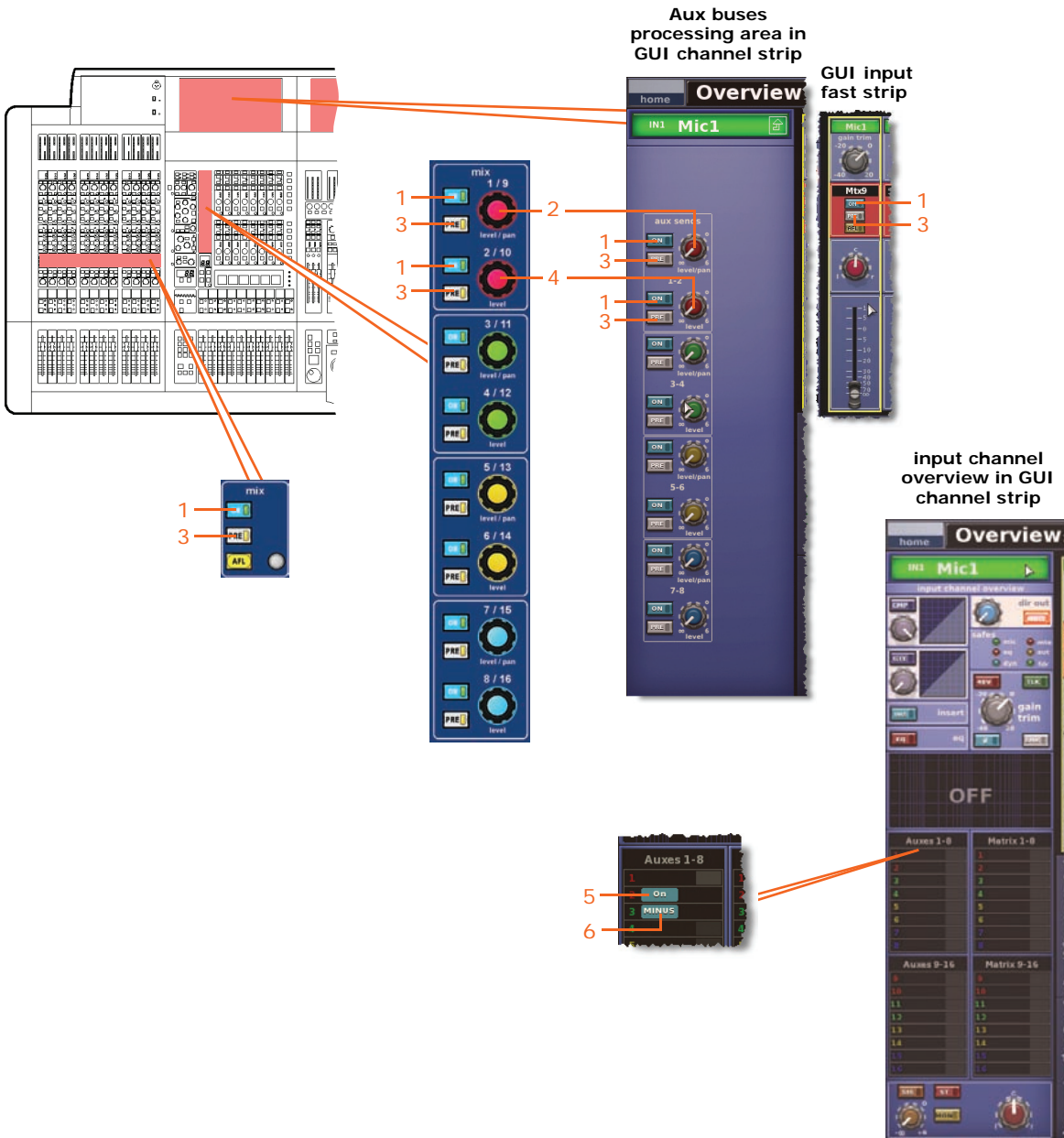

Note: Only matrix sends 1 to 8 are shown above, but a copy/paste operation affects all aux and matrix sends.

Item	Control	Parameter
1	ON switch	Bus send on/off
2	level/pan control knob	Bus level, or pan when bus is linked
3	PRE switch	Pre-fader on/off
4	Control knob	Bus level

Item	Control	Parameter
5	On switch	Aux bus send on/off — only available when aux bus is in group mode
6	MINUS switch	Aux bus send mute on/off — only available when aux bus is in mix minus mode

Master routing

This section shows the parameters of the input master routing affected by copy and paste.

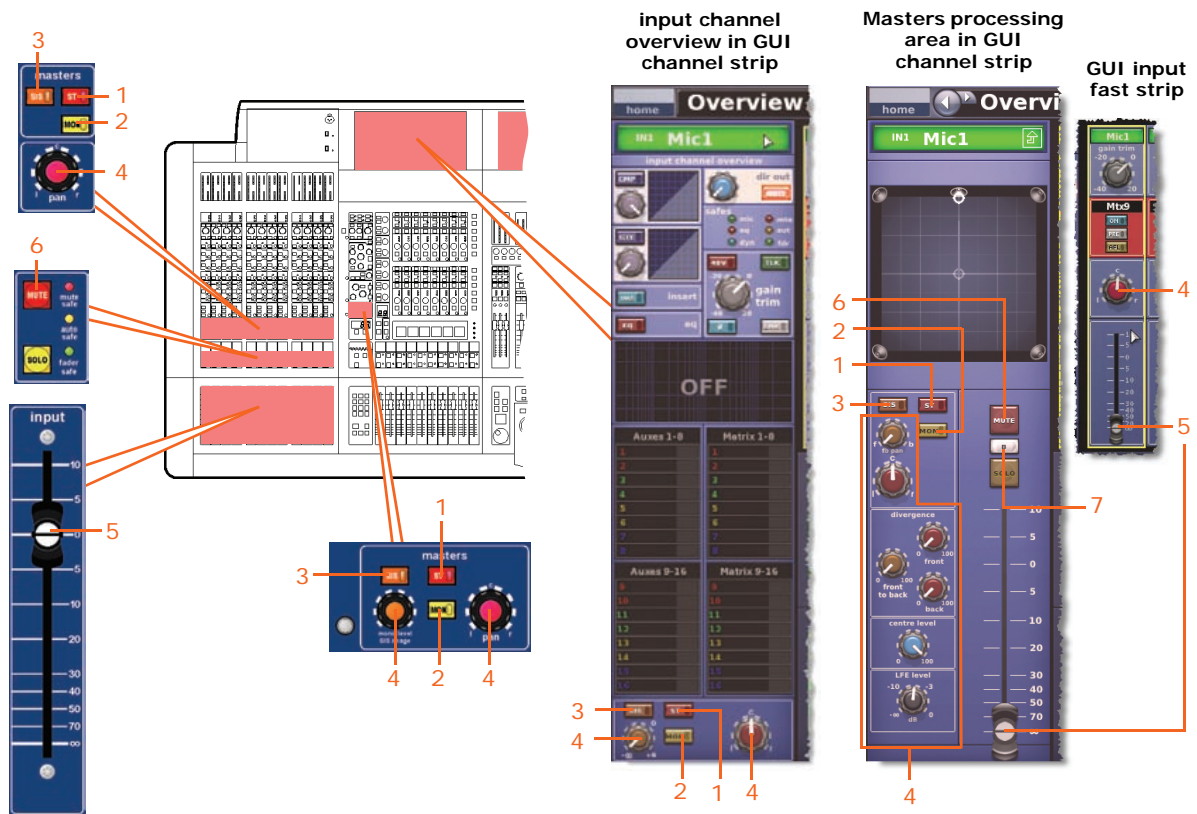

Item	Control	Parameter
1	ST switch	Stereo on/off
2	MON switch	Mono on/off
3	SIS switch	Spatial imaging system on/off
4	Panning control knobs	Surround panning (includes all surround sound parameters)
5	Fader	Level
6	MUTE switch	Mute on/off
7	B switch	Solo B on/off

Aux

This section shows you which aux channel parameters are affected by copy and paste.

Configuration

The following diagram shows the configuration parameters affected by copy and paste.

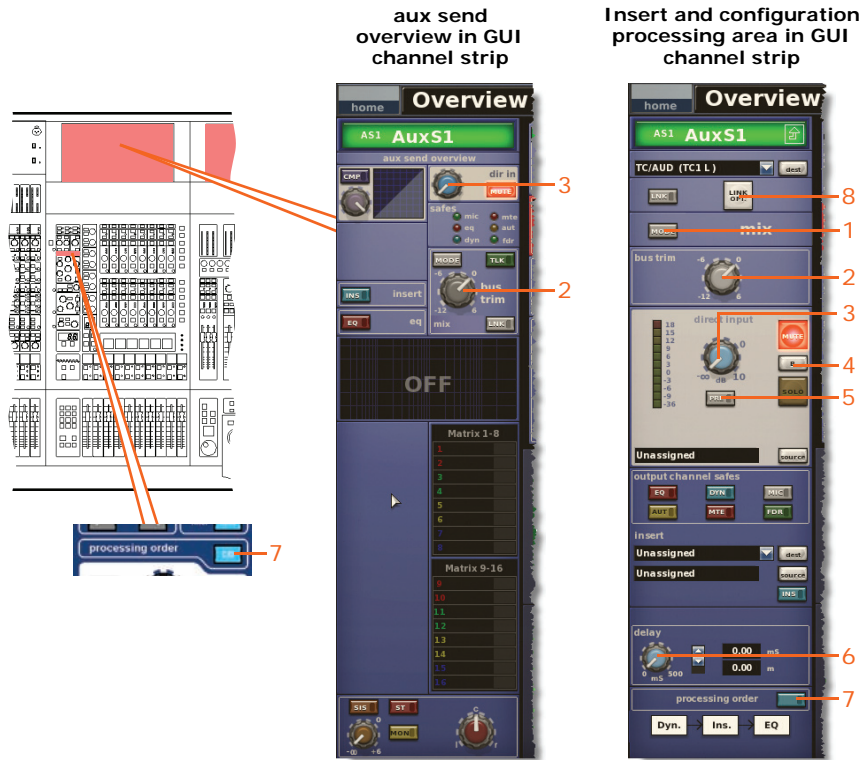

Item	Control	Parameter
1	MODE pushbutton	Bus mode: mix, group or mix minus
2	bus trim control knob	Bus trim level
3	Control knob	Direct input level
4	B switch	Direct input solo B on/off
5	PRE switch	Direct input pre- in/out
6	delay control knob	Delay time
7	C/O switch	Order of processing: Dyn. → Ins. → EQ or EQ → Ins. → Dyn.
8	LINK OPT. button	Stereo linking options

Compressor

This section shows the compression parameters of the dynamics section affected by copy and paste. Only corrective compressor shown below, but this is typically the same for the other compressor modes.

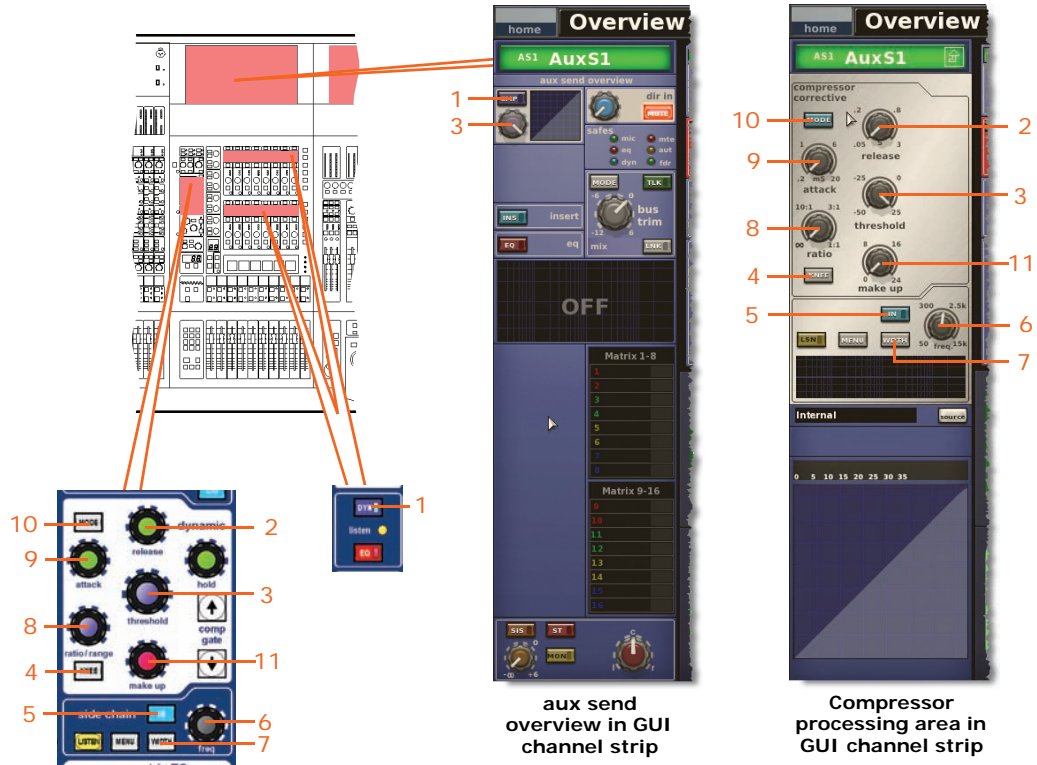

Note: Only the corrective compressor is shown above, but this is typically the same for the other compressor modes (adaptive, creative, vintage and shimmer).

Item	Control	Parameter
1	DYN/[CMP] switch	Compressor on/off
2	release control knob	Compressor release
3	threshold control knob	Compressor threshold
4	KNEE pushbutton	Compressor knee: hard, medium or soft
5	IN switch	Compressor sidechain in/out
6	freq control knob	Compressor sidechain frequency
7	WIDTH pushbutton	Compressor sidechain: 2 Oct, 1 Oct or 0.3 Oct
8	ratio/range/[ratio] control knob	Compressor ratio
9	attack control knob	Compressor attack
10	MODE pushbutton	Compressor mode: corrective, adaptive, creative, vintage or shimmer
11	make up control knob	Compressor gain

Gate

Not applicable.

EQ (GEO)

This section shows the parameters of the EQ section, including the GEQ, affected by copy and paste.

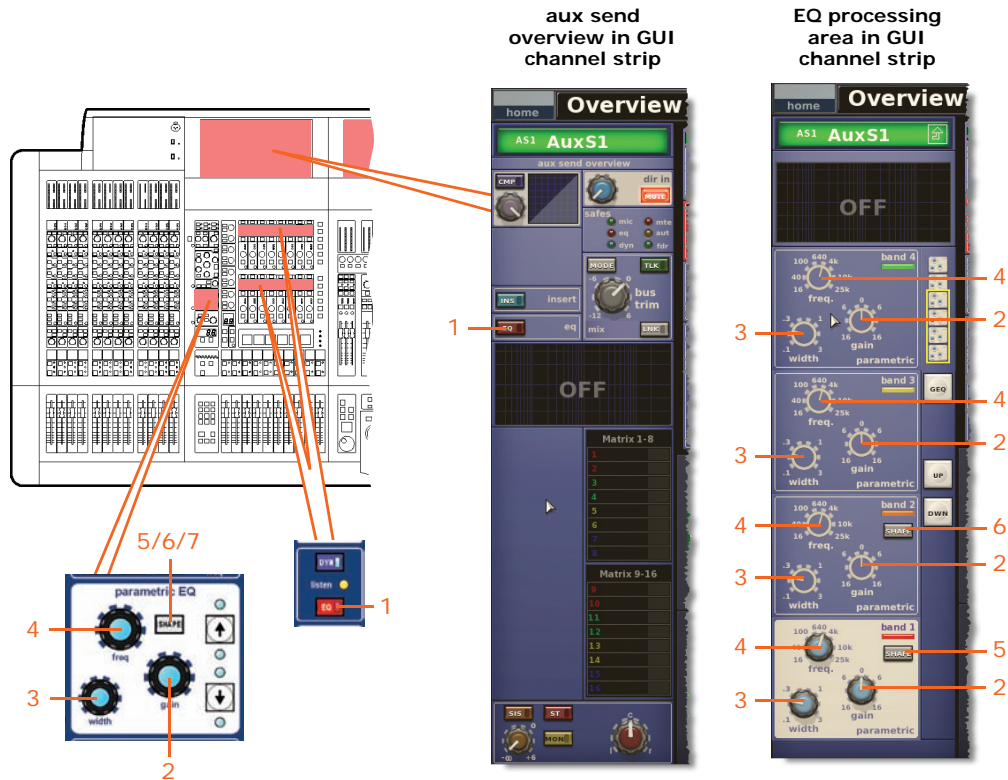

Item	Control	Parameter
1	EQ switch	EQ on/off
2	gain control knob	EQ gain level
3	width control knob	EQ width
4	freq control knob	EQ frequency
5	SHAPE switch	Band 1 shelving mode: bell, warm, high pass 6dB or high pass 12dB
6	SHAPE switch	Band 2 shelving mode: bell or high pass 24dB
7*	SHAPE switch	Band 6 shelving mode: bell, soft, low pass 6dB or low pass 12dB

* Not shown in diagram.

Note: Although band 6 is not shown above, the items in the table also apply. The band has items 2, 3 and 4, and also includes item 7.

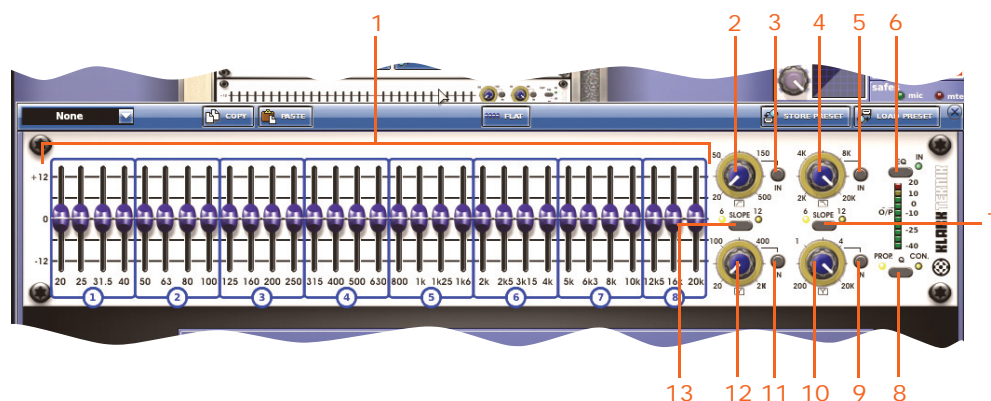

<i>Item</i>	<i>Control</i>	<i>Parameter</i>
1	31 faders	Fader positions
2	High pass filter control knob	High pass filter cut off frequency
3	IN switch	High pass filter in/out
4	Low pass filter control knob	Low pass filter cut off frequency
5	IN switch	Low pass filter in/out
6	EQ switch	EQ in/out
7	SLOPE switch	Low pass filter: 6dB or 12dB
8	Q switch	Q mode as proportional (PROP.) or constant (CON.)
9	IN switch	200Hz - 20kHz notch filter in/out
10	Notch filter control knob	200Hz - 20kHz notch filter frequency
11	IN switch	20Hz - 2kHz notch filter in/out
12	Notch filter control knob	20Hz - 2kHz notch filter frequency
13	SLOPE switch	High pass filter: 6dB or 12dB

Bus sends

This section shows the parameters of the mix buses affected by copy and paste.

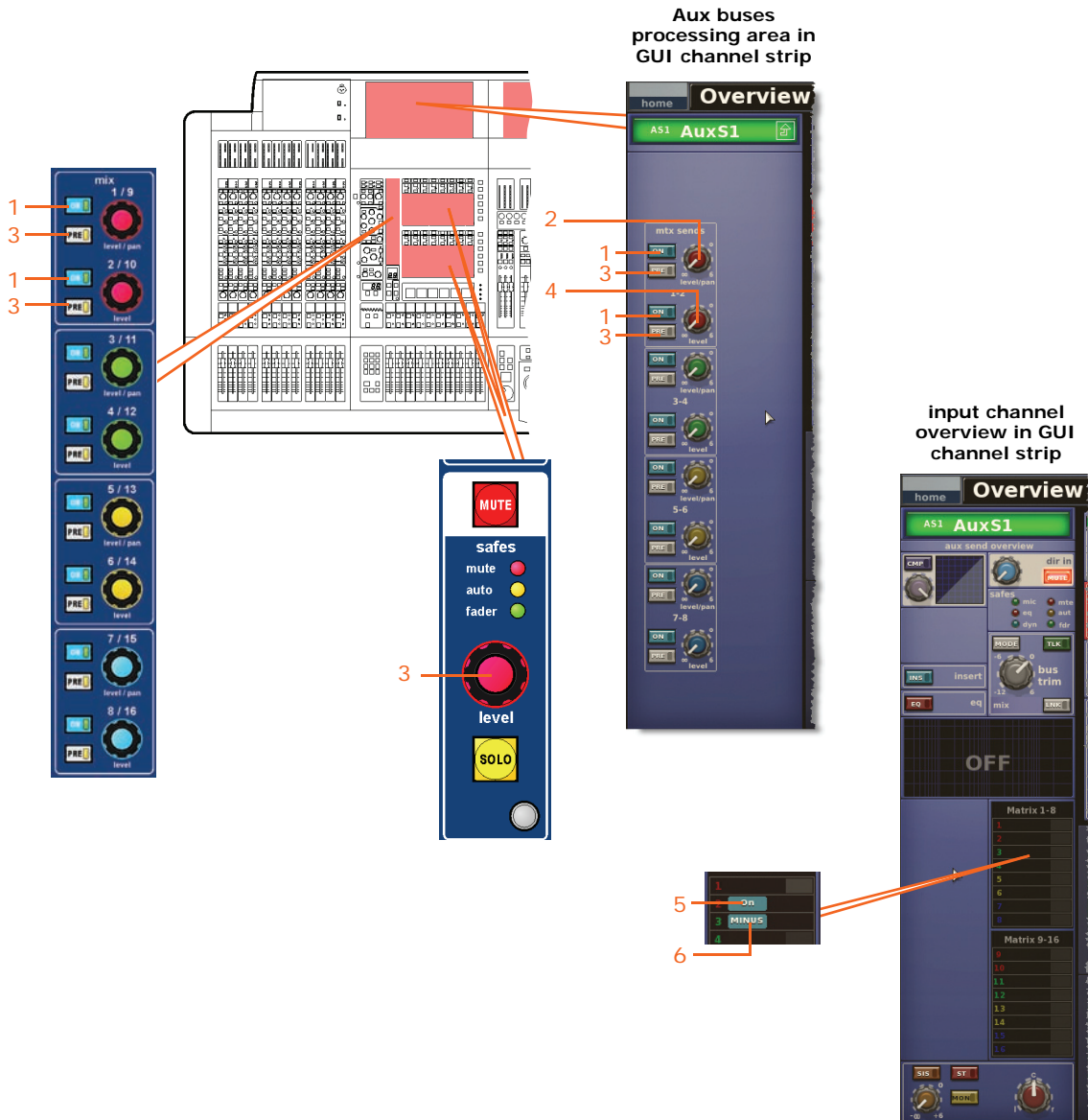

Note: Although only matrix sends 1-2 are referenced above, this also applies to all matrix sends.

Item	Control	Parameter
1	ON switch	Matrix bus send on/off
2	level/pan control knob	Bus level, or pan when bus is linked
3	PRE switch	Pre-fader on/off
4	level control knob	Bus level

Master routing

This section shows all the parameters of the master routing section affected by copy and paste.

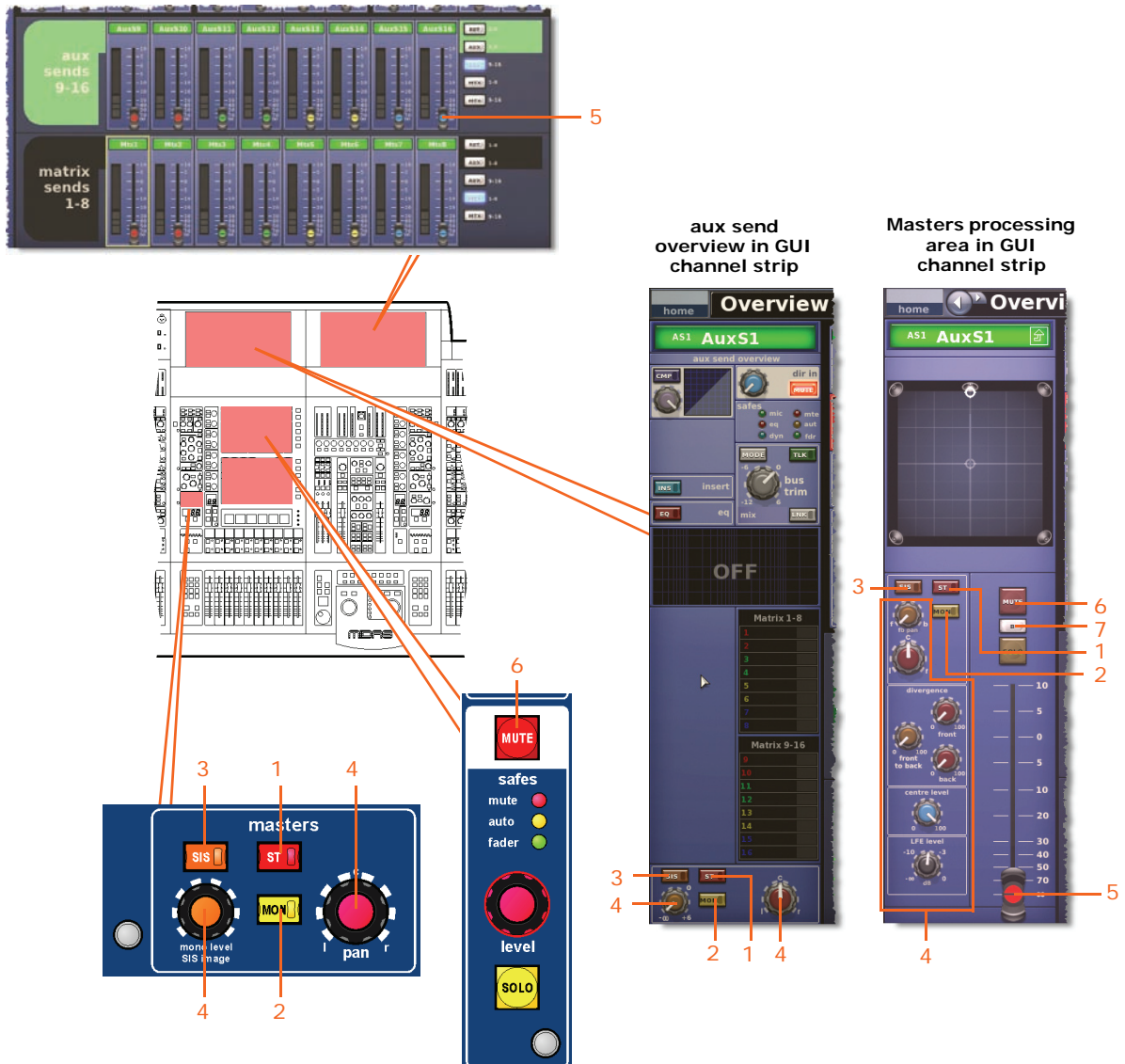

Item	Control	Parameter
1	ST switch	Stereo on/off
2	MON switch	Mono on/off
3	SIS switch	Spatial imaging system on/off
4	Panning control knobs	Surround panning (includes all surround sound parameters)
5	Fader	Level
6	MUTE switch	Mute on/off
7	B switch	Solo B on/off

Return

This section shows you which return channel parameters are affected by copy and paste.

Configuration

The following diagram shows the configuration parameters affected by copy and paste.

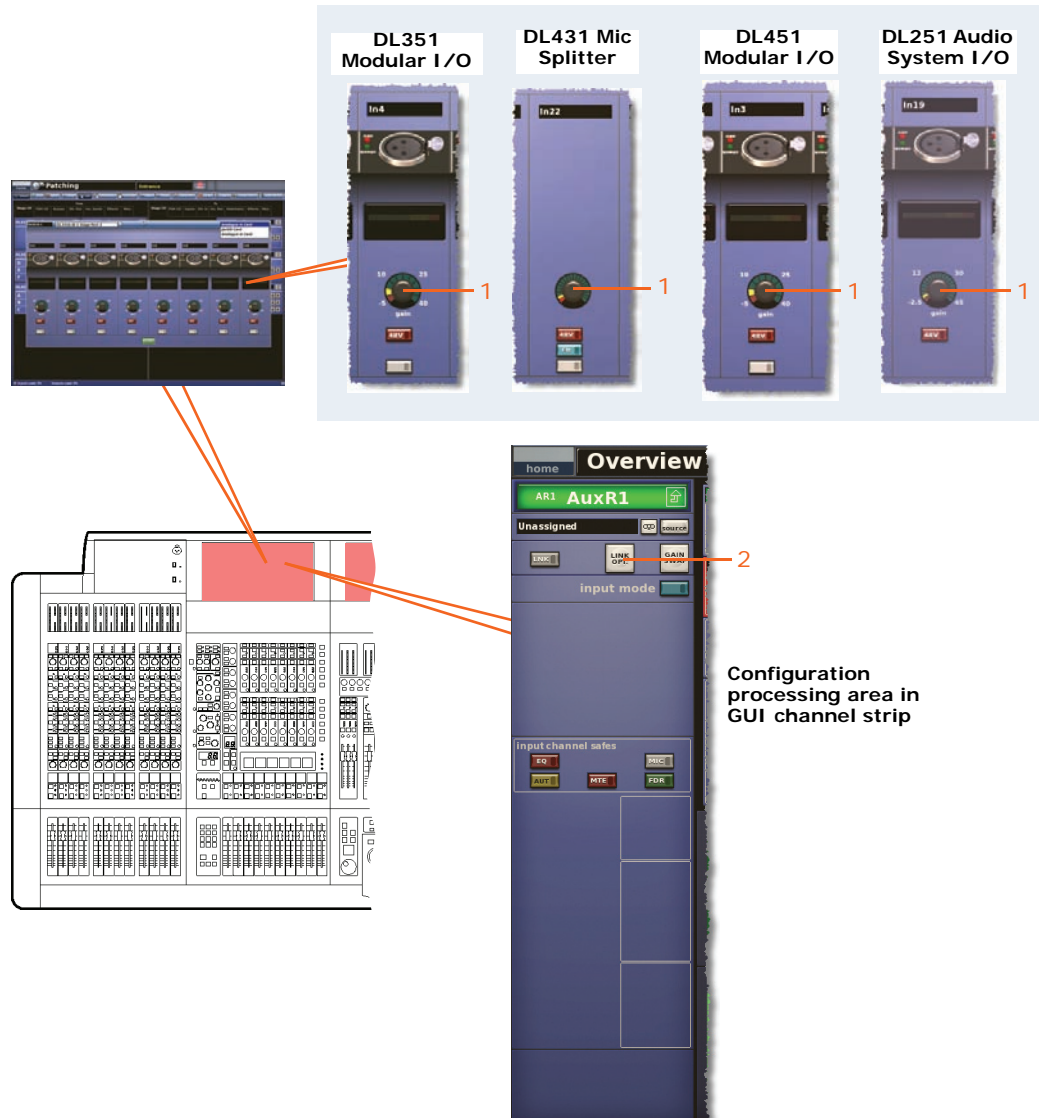

Item	Control	Parameter
1	Stage box control knob	Gain of remote amplifier
2	LINK OPT. button	Stereo linking options

Compressor

Not applicable.

Gate

Not applicable.

EQ

Not applicable.

Bus sends

This following diagram shows the return parameters of the mix sections affected by copy and paste.

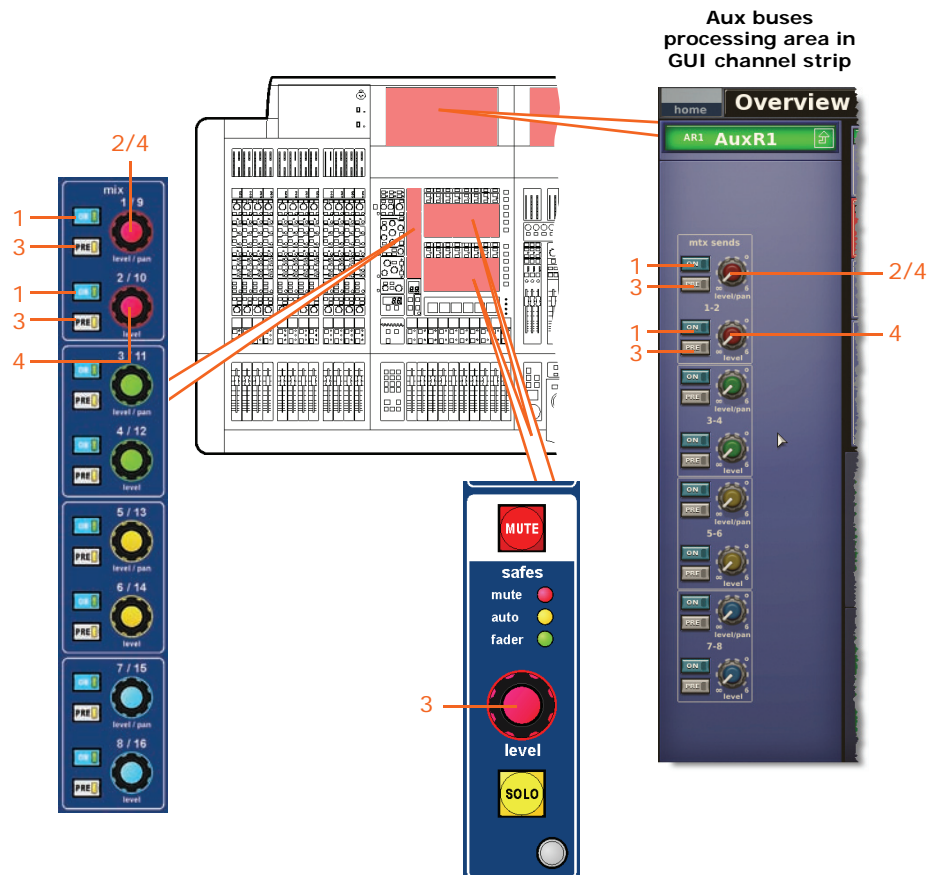

Note: Although only matrix sends 1-2 are referenced above, this applies to all 16 matrix sends.

Item	Control	Parameter
1	ON switch	Matrix bus send on/off
2	level/pan control knob	Bus level, or pan when bus is linked
3	PRE switch	Pre-fader on/off
4	level control knob	Bus level

Master routing

This section shows all the parameters of the master routing affected by copy and paste.

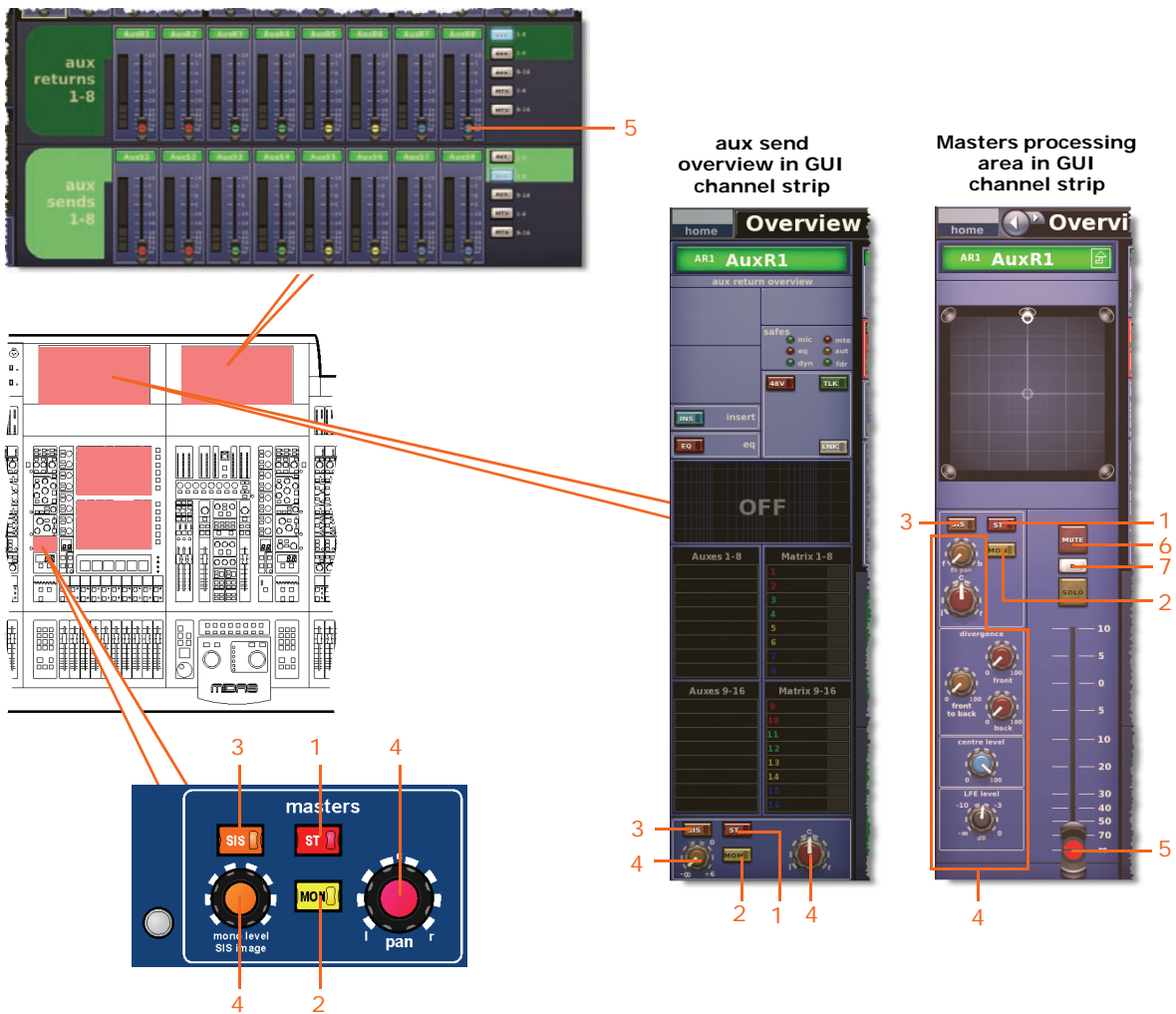

Item	Control	Parameter
1	ST switch	Stereo on/off
2	MON switch	Mono on/off
3	SIS switch	Spatial imaging system on/off
4	Panning control knobs	Surround panning (includes all surround sound parameters)
5	Fader	Level
6	MUTE switch	Mute on/off
7	B switch	Solo B on/off

Matrix

This section shows you which matrix channel parameters are affected by copy and paste.

Configuration

The following diagram shows the configuration parameters affected by copy and paste.

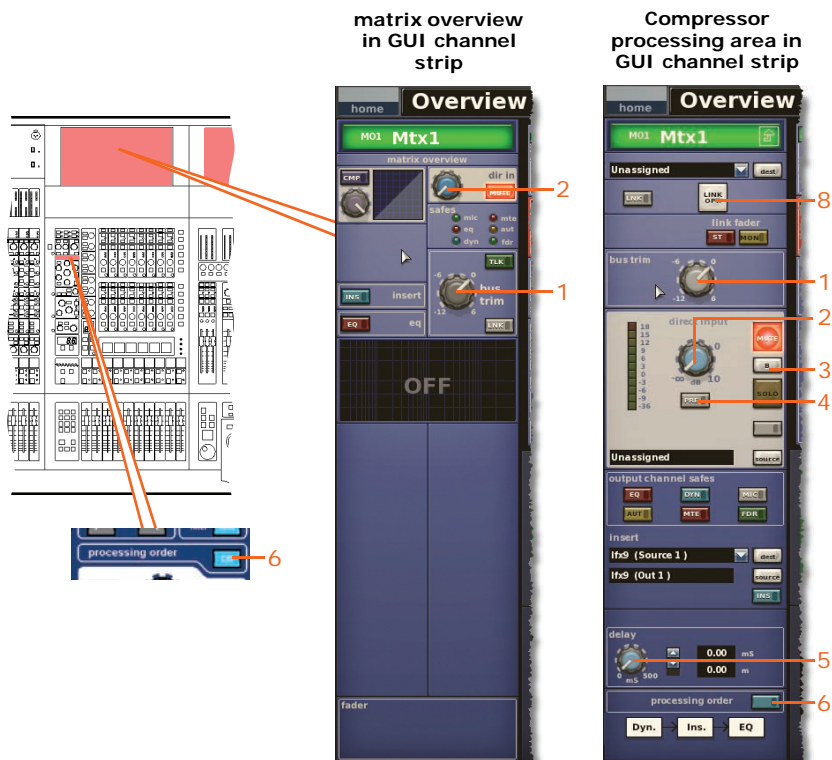

Item	Control	Parameter
1	bus trim control knob	Bus trim level
2	Control knob	Direct input level
3	B switch	Direct input solo B on/off
4	PRE switch	Direct input pre- in/out
5	delay control knob	Delay time
6	C/O switch	Order of processing: Dyn.→Ins.→EQ or EQ→Ins.→Dyn.

Compressor

This section shows all the compression parameters of the dynamics section affected by copy and paste.

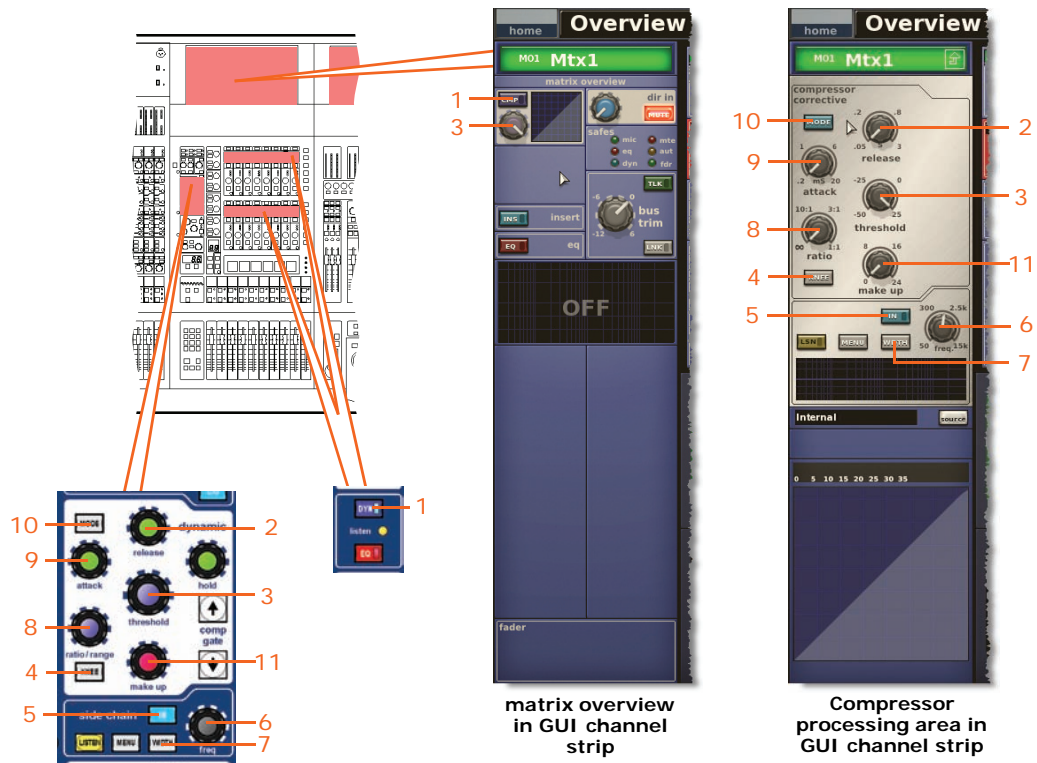

Note: Only the corrective compressor is shown above, but this is typically the same for the other compressor modes (adaptive, creative, vintage and shimmer).

Item	Control	Parameter
1	DYN/[CMP] switch	Compressor on/off
2	release control knob	Compressor release
3	threshold control knob	Compressor threshold
4	KNEE pushbutton	Compressor knee: hard, medium or soft
5	IN switch	Compressor sidechain in/out
6	freq control knob	Compressor sidechain frequency
7	WIDTH pushbutton	Compressor sidechain width: 2 Oct, 1 Oct or 0.3 Oct
8	ratio/range/[ratio] control knob	Compressor ratio
9	attack control knob	Compressor attack
10	MODE pushbutton	Compressor mode: corrective, adaptive, creative, vintage or shimmer
11	make up control knob	Compressor gain

Gate

Not applicable.

EQ (GEQ)

This section shows the parameters of the EQ section (including the GEQ) affected by copy and paste.

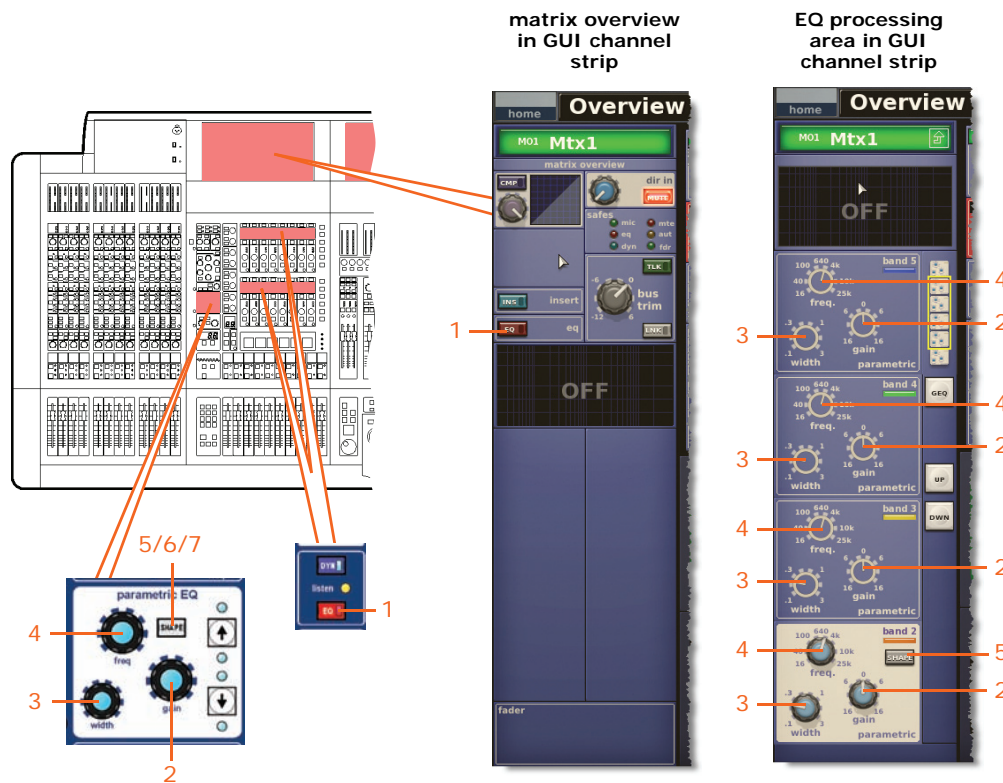

Item	Control	Parameter
1	EQ switch	EQ on/off
2	gain control knob	EQ gain level
3	width control knob	EQ width
4	freq control knob	EQ frequency
5*	SHAPE switch	Band 6 shelving mode: bell, soft, low pass 6dB or low pass 12dB
6	SHAPE switch	Band 2 shelving mode: bell or high pass 24dB
7*	SHAPE switch	Band 1 shelving mode: bell, warm, high pass 6dB or high pass 12dB

* Not shown in diagram.

Note: Although bands 1 and 6 are not shown above, the items in the table also apply. Both bands have items 2, 3 and 4. Band 1 also has item 7, and band 6 also has item 5.

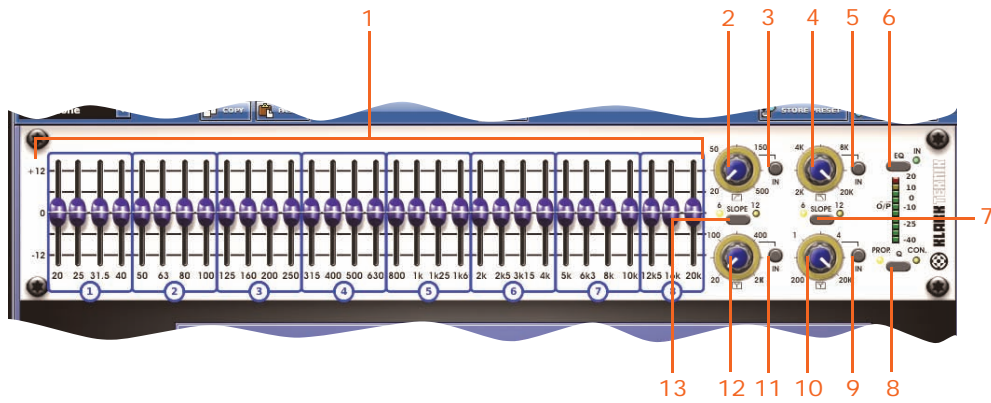

<i>Item</i>	<i>Control</i>	<i>Parameter</i>
1	31 faders	Fader positions
2	High pass filter control knob	High pass filter cut off frequency
3	IN switch	High pass filter in/out
4	Low pass filter control knob	Low pass filter cut off frequency
5	IN switch	Low pass filter in/out
6	EQ switch	EQ in/out
7	SLOPE switch	Low pass filter: 6dB or 12dB
8	Q switch	Q mode as proportional (PROP.) or constant (CON.)
9	IN switch	200Hz - 20kHz notch filter in/out
10	Notch filter control knob	200Hz - 20kHz notch filter frequency
11	IN switch	20Hz - 2kHz notch filter in/out
12	Notch filter control knob	20Hz - 2kHz notch filter frequency
13	SLOPE switch	High pass filter: 6dB or 12dB

Bus sends

Not applicable.

Fader section

This section shows all the parameters of the master routing affected by copy and paste.

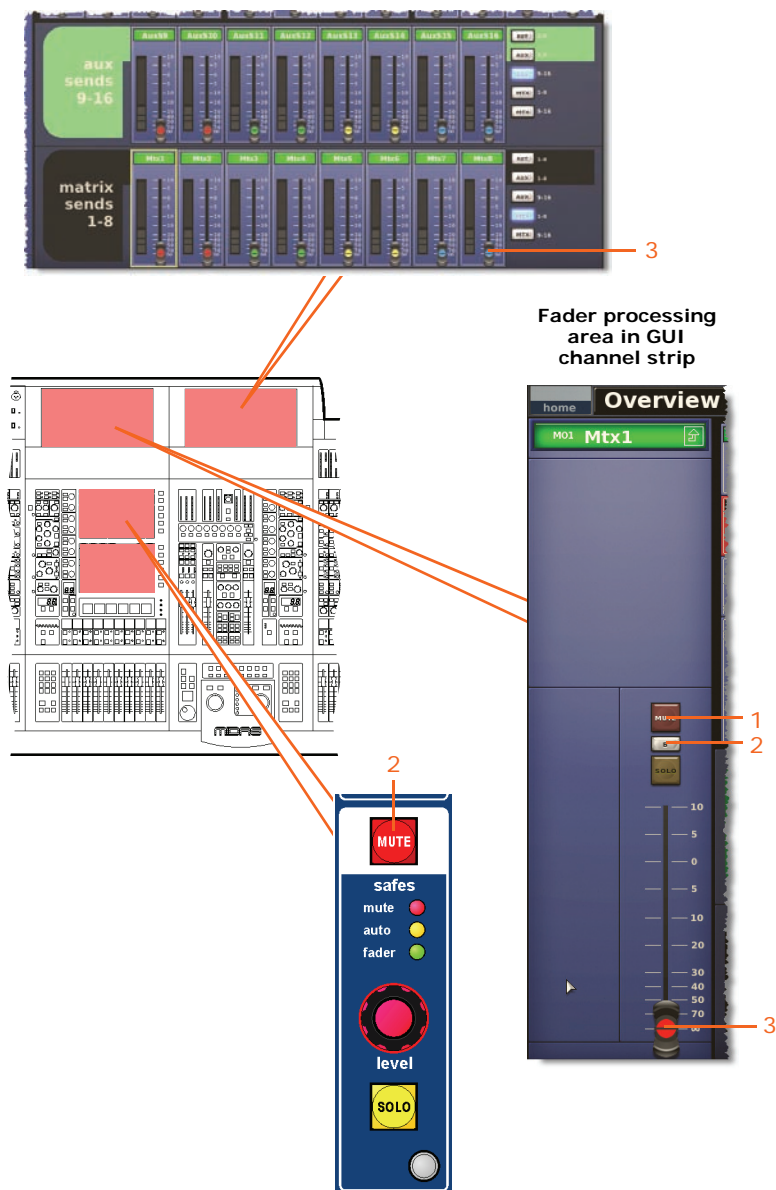

<i>Item</i>	<i>Control</i>	<i>Parameter</i>
1	MUTE switch	Mute on/off
2	B switch	Solo B on/off
3	Fader	Level

Master

This section shows you which master channel parameters are affected by copy and paste.

Configuration

The following diagram shows the configuration parameters affected by copy and paste.

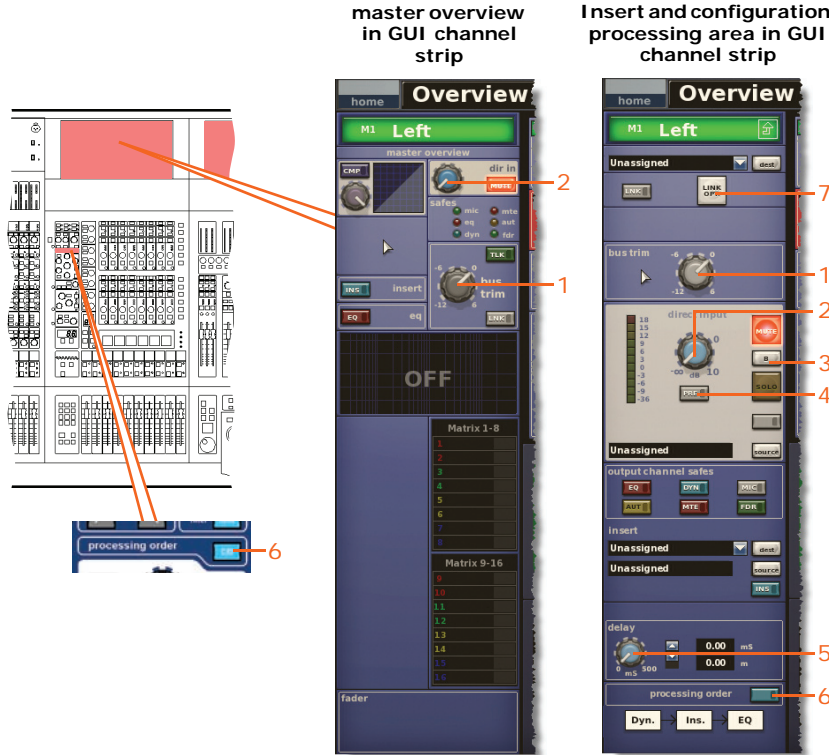

Item	Control	Parameter
1	bus trim control knob	Bus trim level
2	Control knob	Direct input level
3	B switch	Direct input solo B on/off
4	PRE switch	Direct input pre- in/out
5	delay control knob	Delay level
6	C/O switch	Order of processing: Dyn. → Ins. → EQ or EQ → Ins. → Dyn.
7	LINK OPT. button	Stereo linking options

Compressor

This section shows the compression parameters of the dynamics section affected by copy and paste. Only corrective compressor shown below, but typically the same for the other compressor modes.

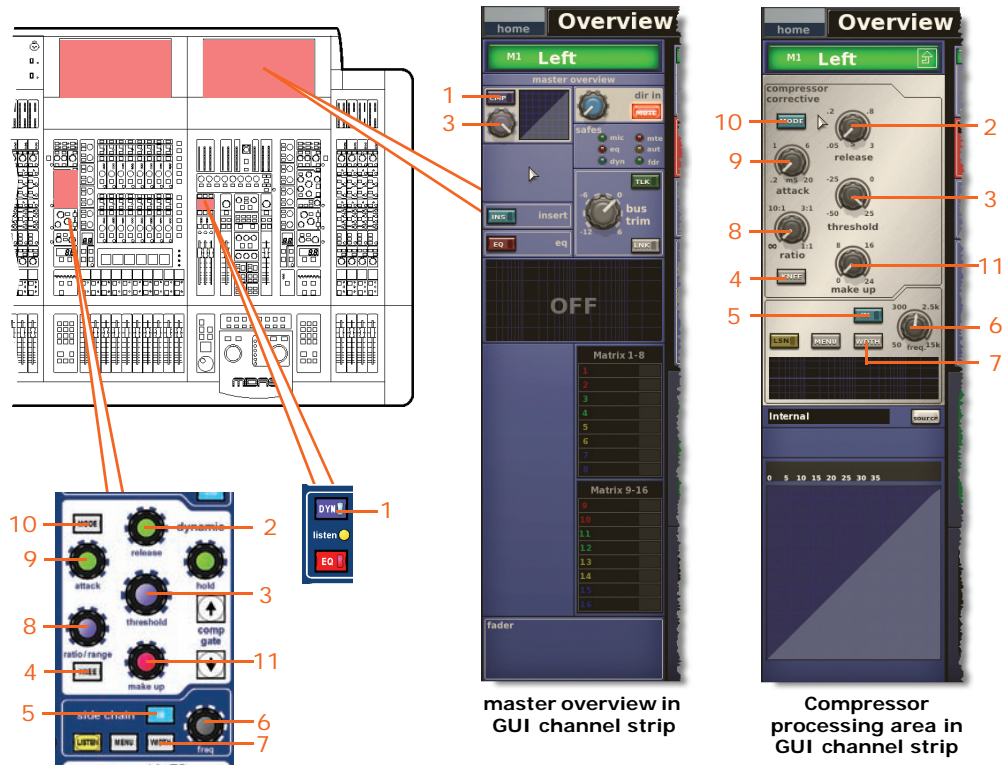

Note: Only the corrective compressor is shown above, but this is typically the same for the other compressor modes (adaptive, creative, vintage and shimmer).

Item	Control	Parameter
1	DYN/[CMP] switch	Compressor on/off
2	release control knob	Compressor release
3	threshold control knob	Compressor threshold
4	KNEE pushbutton	Compressor knee: hard, medium or soft
5	IN switch	Compressor sidechain in/out
6	freq control knob	Compressor sidechain frequency
7	WIDTH pushbutton	Compressor sidechain width: 2 Oct, 1 Oct or 0.3 Oct
8	ratio/range/[ratio] control knob	Compressor ratio
9	attack control knob	Compressor attack
10	MODE pushbutton	Compressor mode: corrective, adaptive, creative, vintage or shimmer
11	make up control knob	Compressor gain

Gate

Not applicable.

EQ (GEO)

The following diagram shows the parameters of the EQ section (including the GEO) affected by copy and paste.

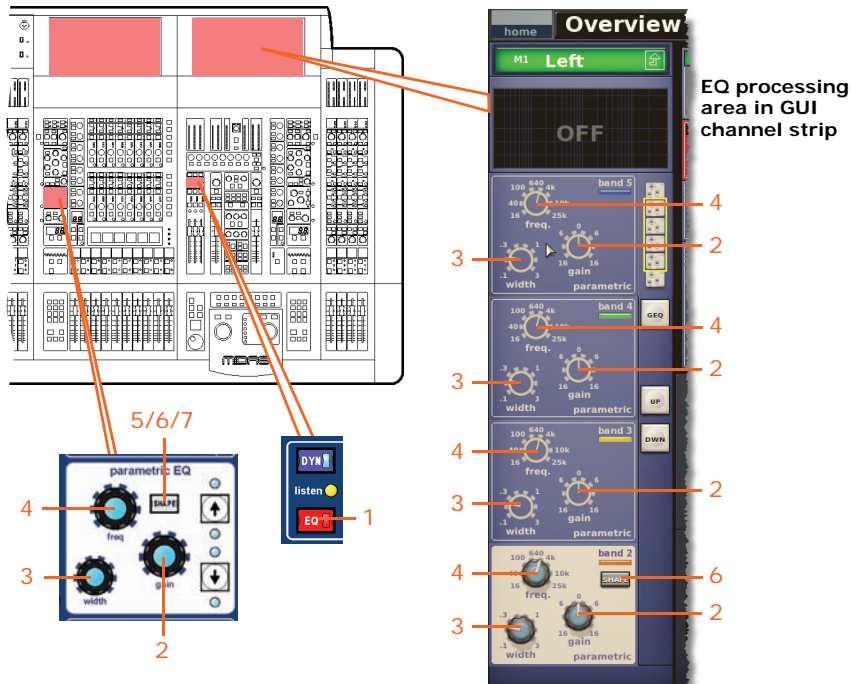

Item	Control	Parameter
1	EQ switch	EQ on/off
2	gain control knob	EQ gain level
3	width control knob	EQ width
4	freq control knob	EQ frequency
5*	SHAPE switch	Band 6 shelving mode: bell, soft, low pass 6dB or low pass 12dB
6	SHAPE switch	Band 2 shelving mode: bell or high pass 24dB
7*	SHAPE switch	Band 1 shelving mode: bell, warm, high pass 6dB or high pass 12dB

* Not shown in diagram.

Note: Although bands 1 and 6 are not shown above, the items in the table also apply. Both bands have items 2, 3 and 4. Band 1 also has item 7, and band 6 also has item 5.

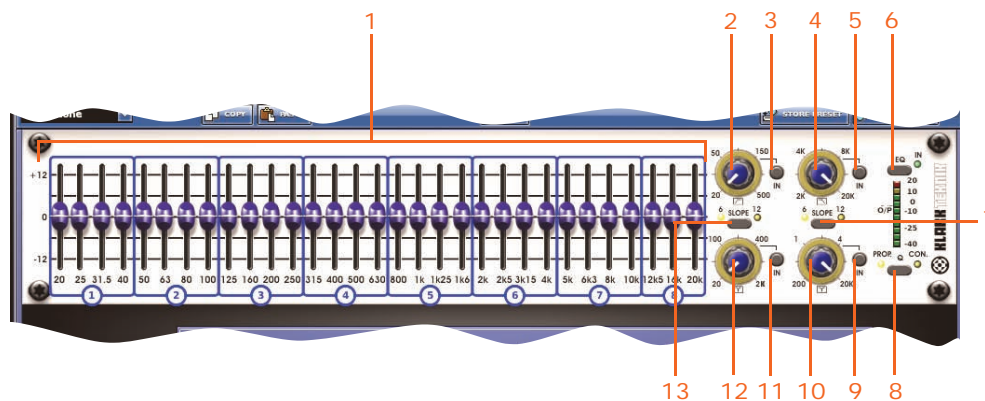

<i>Item</i>	<i>Control</i>	<i>Parameter</i>
1	31 faders	Fader positions
2	High pass filter control knob	High pass filter cut off frequency
3	IN switch	High pass filter in/out
4	Low pass filter control knob	Low pass filter cut off frequency
5	IN switch	Low pass filter in/out
6	EQ switch	EQ in/out
7	SLOPE switch	Low pass filter: 6dB or 12dB
8	Q switch	Q mode as proportional (PROP.) or constant (CON.)
9	IN switch	200Hz - 20kHz notch filter in/out
10	Notch filter control knob	200Hz - 20kHz notch filter frequency
11	IN switch	20Hz - 2kHz notch filter in/out
12	Notch filter control knob	20Hz - 2kHz notch filter frequency
13	SLOPE switch	High pass filter: 6dB or 12dB

Bus sends

Not applicable.

Master routing

This section shows all the parameters of the master routing affected by copy and paste.

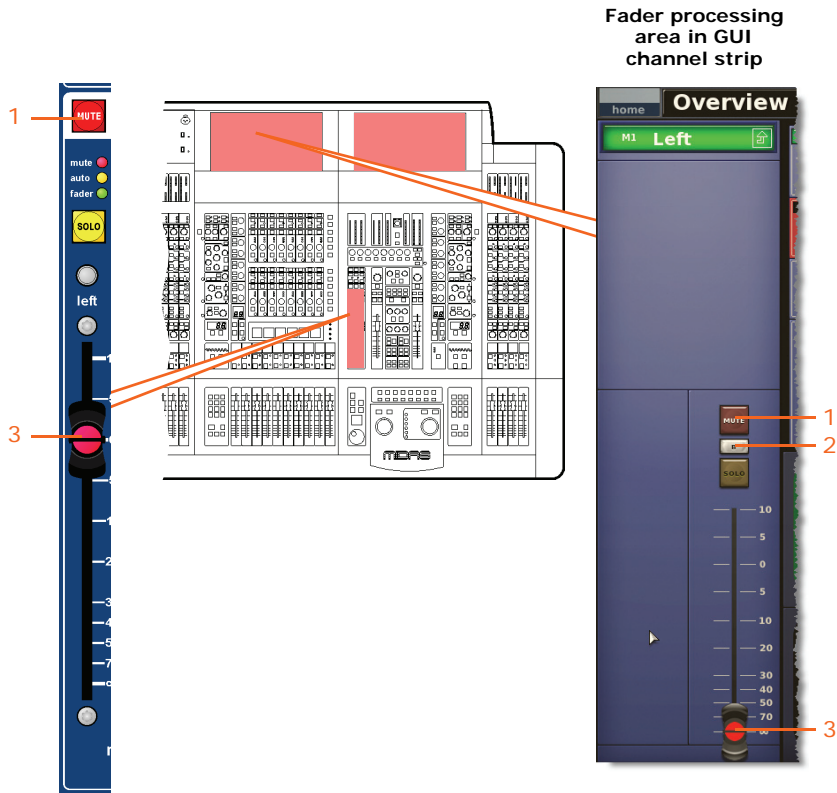

<i>Item</i>	<i>Control</i>	<i>Parameter</i>
1	MUTE switch	Mute on/off
2	B switch	Solo B on/off
3	Fader	Level

Appendix O: Parameters Affected By Stereo Linking

This appendix shows the parameters that are linked per control area (selectable globally and per pair).

Note: Some of the GUI displays in this appendix may look slightly different to the ones on the PRO Series Control Centre you are using, as they may be taken from a different type of PRO Series Live Audio System. For example, the PRO3 doesn't have a **Matrix 9 - 16** section in the GUI channel strip. However, all of the parameters affected by stereo linking still apply.

Overview

The following table shows what parameters per control area are linked across a channel pair.

<i>Control area</i>	<i>Input Channels</i>	<i>Aux Sends (Auxes)</i>	<i>Aux Returns (Returns)</i>	<i>Matrix (Matrices)</i>	<i>Masters</i>
Input Controls	See page 540	See page 551	See page 560	See page 565	See page 573
Direct Output	See page 541	N/A	N/A	N/A	N/A
Direct Input	See page 541	See page 552	N/A	See page 566	See page 574
Filters	See page 542	N/A	N/A	N/A	N/A
Dynamics	See page 543	See page 553	N/A	See page 567	See page 575
Insert	See page 545	See page 554	N/A	See page 568	See page 576
EQ	See page 546	See page 555	N/A	See page 569	See page 577
Bus Sends	See page 547	See page 556	See page 562	N/A	N/A
Master Routing	See page 548	See page 557	See page 563	N/A	N/A
Fader	See page 549	See page 558	See page 564	See page 571	See page 578
Delay	See page 550	See page 559	N/A	See page 572	See page 579

Inputs

This section shows the linked parameters of the input channels.

Input controls

The following diagram shows the input control parameters that are linked across a channel pair.

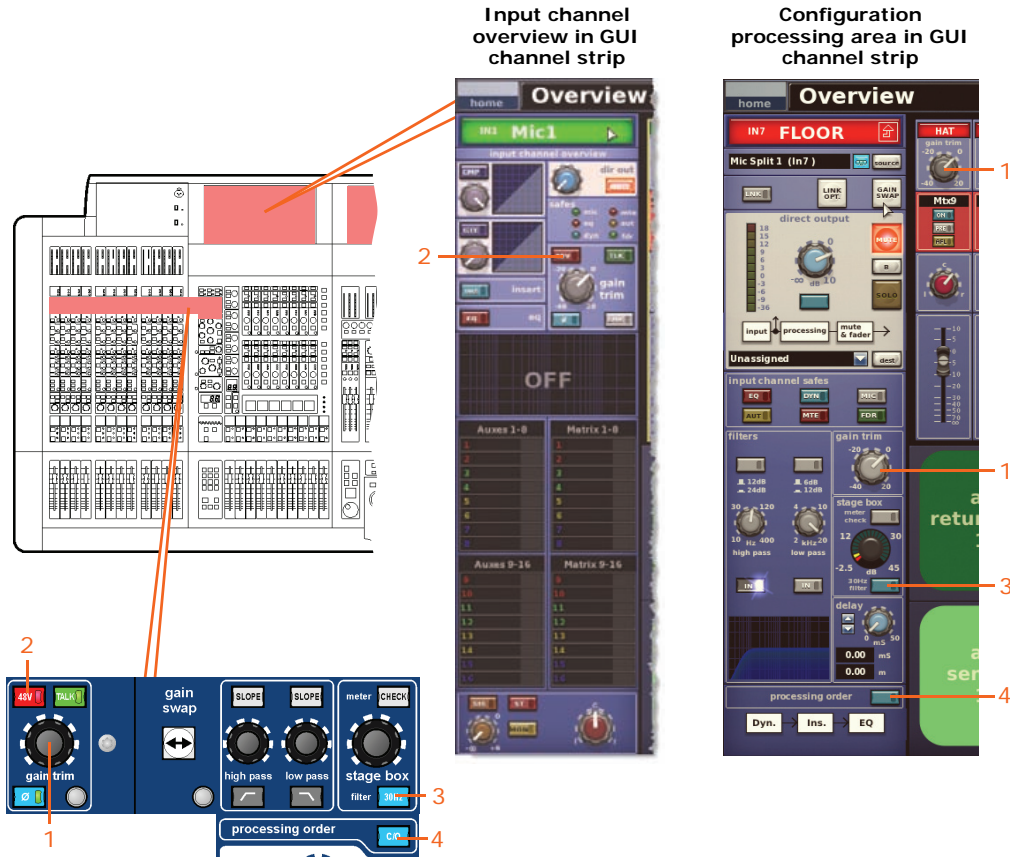

Item	Control	Parameter
1	gain trim control knob	Digital trim level
2	48V switch*	48V phantom voltage on/off
3	30Hz switch	30Hz filter in/out
4	C/O switch*	Order of processing: Dyn. → Ins. → EQ or EQ → Ins. → Dyn.

* Applicable to tape and primary inputs.

Direct output

The following diagram shows the direct output control parameters that are linked across a channel pair.

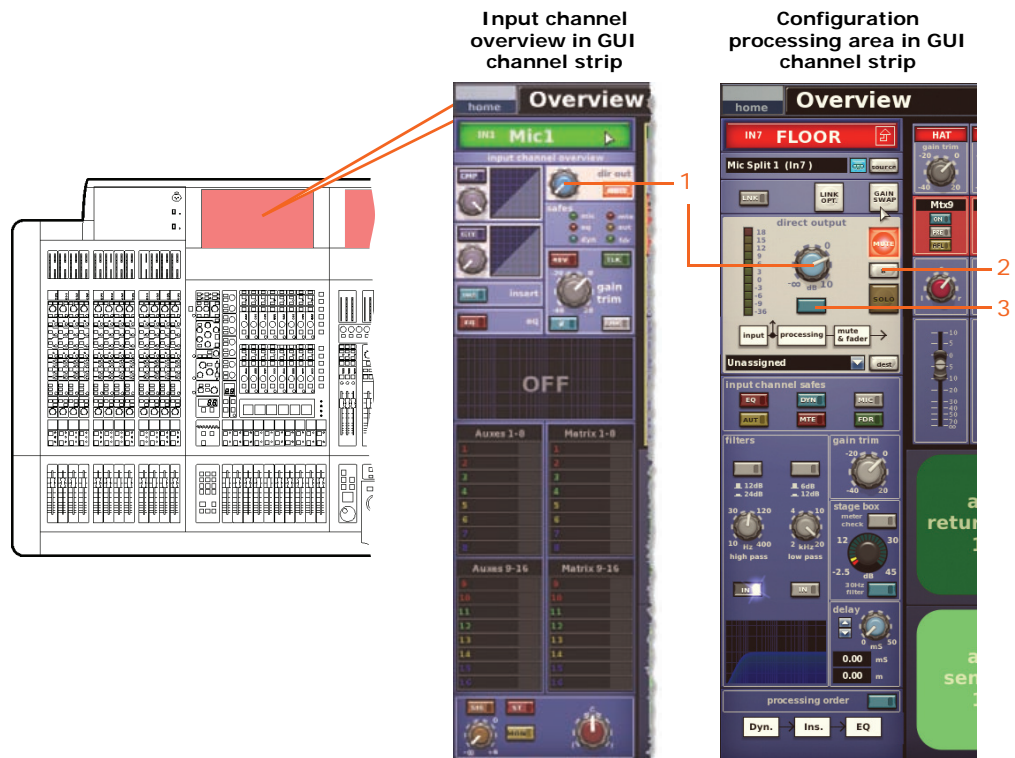

<i>Item</i>	<i>Control</i>	<i>Parameter</i>
1	Control knob	Direct output level
2	B switch	Direct output solo B in/out
3	Pushbutton	Direct output tap-off point: "Post-fade and mute", "Pre-mute, pre-processing" or "Pre-mute, post-processing"

Direct input

Not applicable.

Filters

The following diagram shows the parameters of the filters section affected by stereo linking.

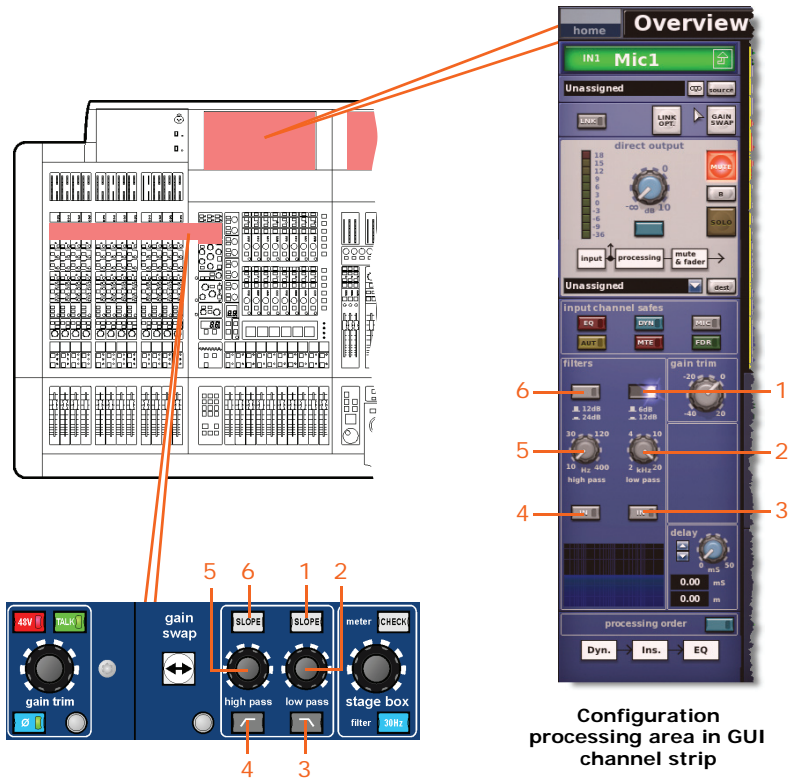

Configuration processing area in GUI channel strip

Item	Control	Parameter
1	SLOPE pushbutton	Low pass filter slope 6dB or 12dB
2	low pass control knob	Low pass filter frequency
3	<input type="checkbox"/> /[IN] switch	Low pass filter in/out
4	<input type="checkbox"/> /[IN] switch	High pass filter in/out
5	high pass control knob	High pass filter frequency
6	SLOPE pushbutton	High pass filter slope 12dB or 24dB

Dynamics

The following diagram shows the compressor and gate parameters of the dynamics section affected by stereo linking.

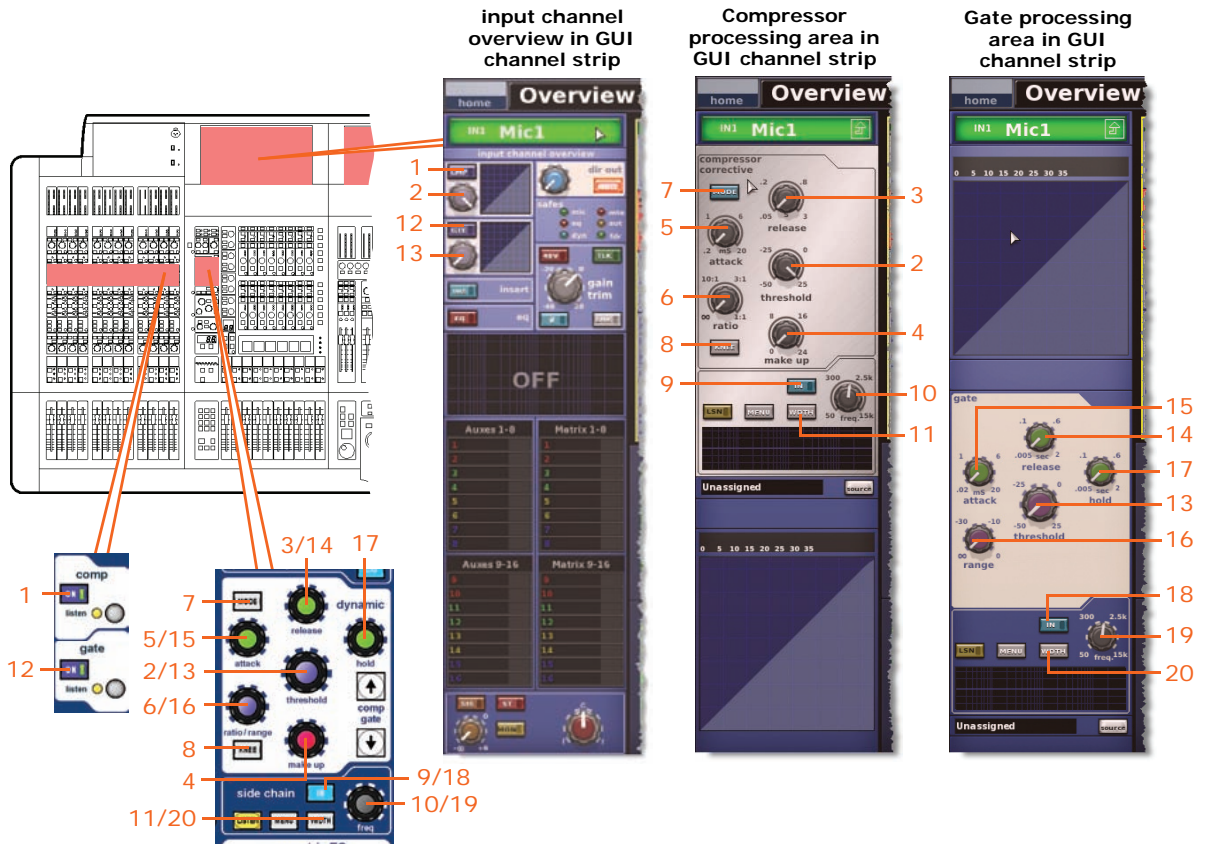

Note: Only the corrective compressor is shown above, but this is typically the same for the other compressor modes (adaptive, creative and vintage).

Item	Control	Parameter
1	ON/[CMP] switch	Compressor on/off
2	threshold control knob	Compressor threshold
3	release control knob	Compressor release
4	make up control knob	Compressor make up gain
5	attack control knob	Compressor attack
6	ratio/range/[ratio] control knob	Compressor ratio
7	MODE pushbutton	Compressor mode: corrective, adaptive, creative or vintage
8	KNEE pushbutton	Compressor knee: hard, medium or soft
9	IN switch	Compressor sidechain in/out
10	freq control knob	Compressor sidechain frequency
11	WIDTH pushbutton	Compressor sidechain width: 2 Oct, 1 Oct or 0.3 Oct

<i>Item</i>	<i>Control</i>	<i>Parameter</i>
12	ON /[GTE] switch	Gate on/off
13	threshold control knob	Gate threshold
14	release control knob	Gate release
15	attack control knob	Gate attack
16	ratio/range /[range] control knob	Gate range
17	hold control knob	Gate hold
18	IN switch	Gate sidechain in/out
19	freq control knob	Gate sidechain frequency
20	WIDTH pushbutton	Gate sidechain width (unlabelled) selector: 2 Oct, 1 Oct and 0.3 Oct

Note: The compressor and gate sidechains of stereo paired channels are always linked such that they ensure the same amount of gain reduction is applied to both channels.

Insert

The following diagram shows the parameters of the insert section affected by stereo linking.

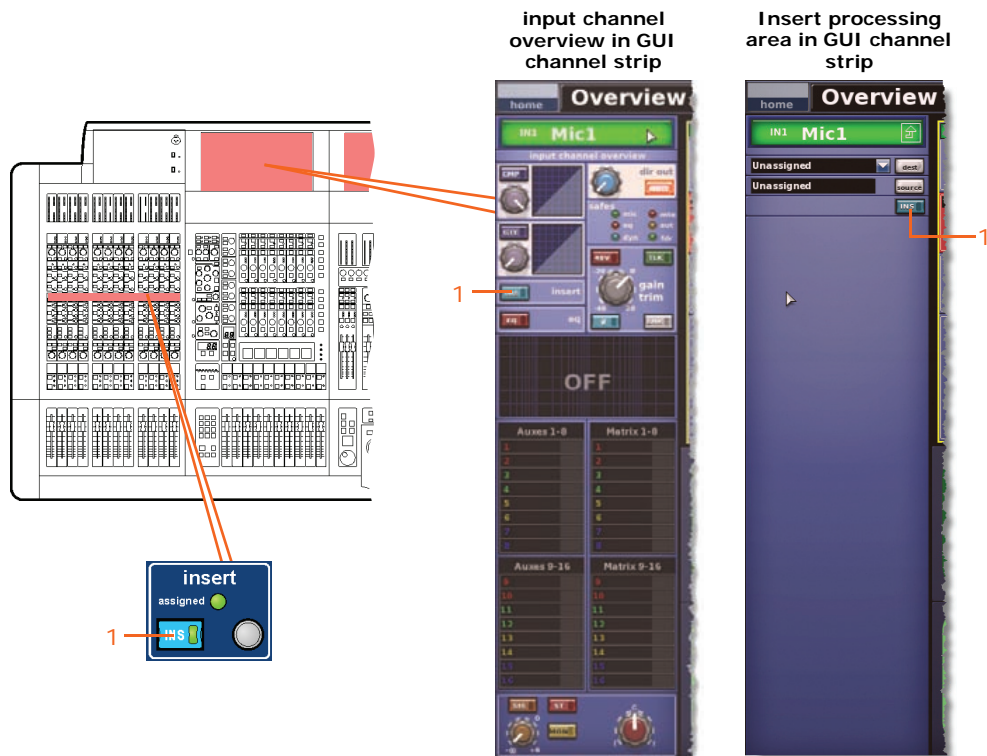

<i>Item</i>	<i>Control</i>	<i>Parameter</i>
1	INS switch	Insert in/out

EQ

The following diagram shows the EQ parameters affected by stereo linking.

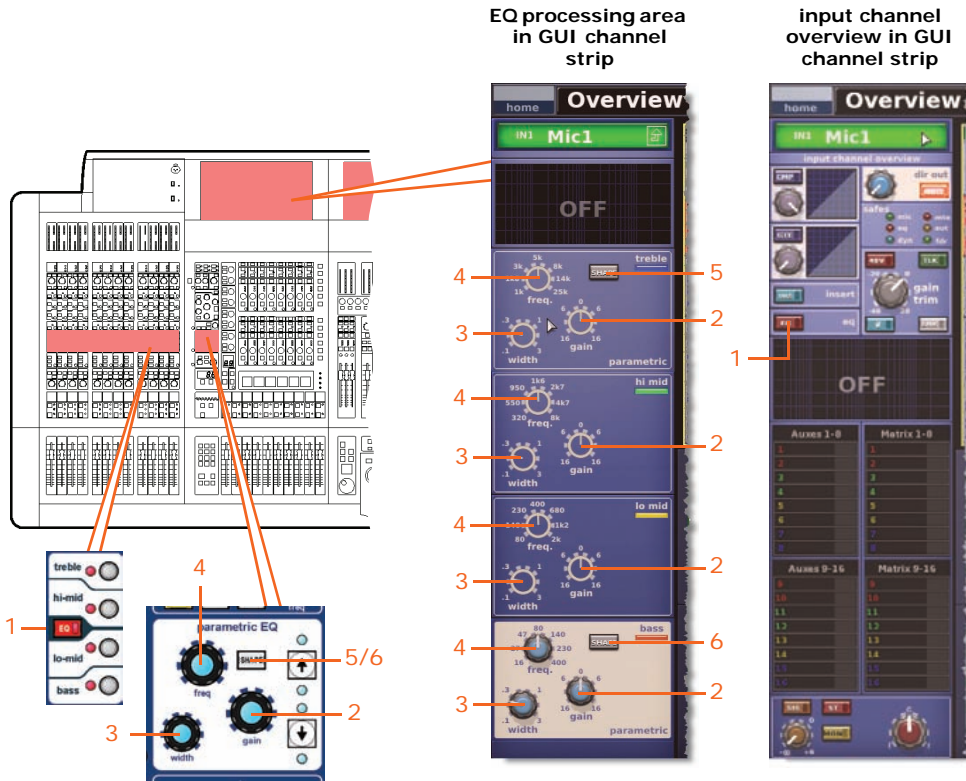

Item	Control	Parameter
1	EQ switch	EQ on/off
2	gain control knob	EQ gain level
3	width control knob	EQ width
4	freq control knob	EQ frequency
5	SHAPE switch	Treble shelving mode: peaking, bright, classic or soft
6	SHAPE switch	Bass shelving mode: peaking, deep, classic or warm

Bus sends

The following diagram shows the input bus sends affected by stereo linking.

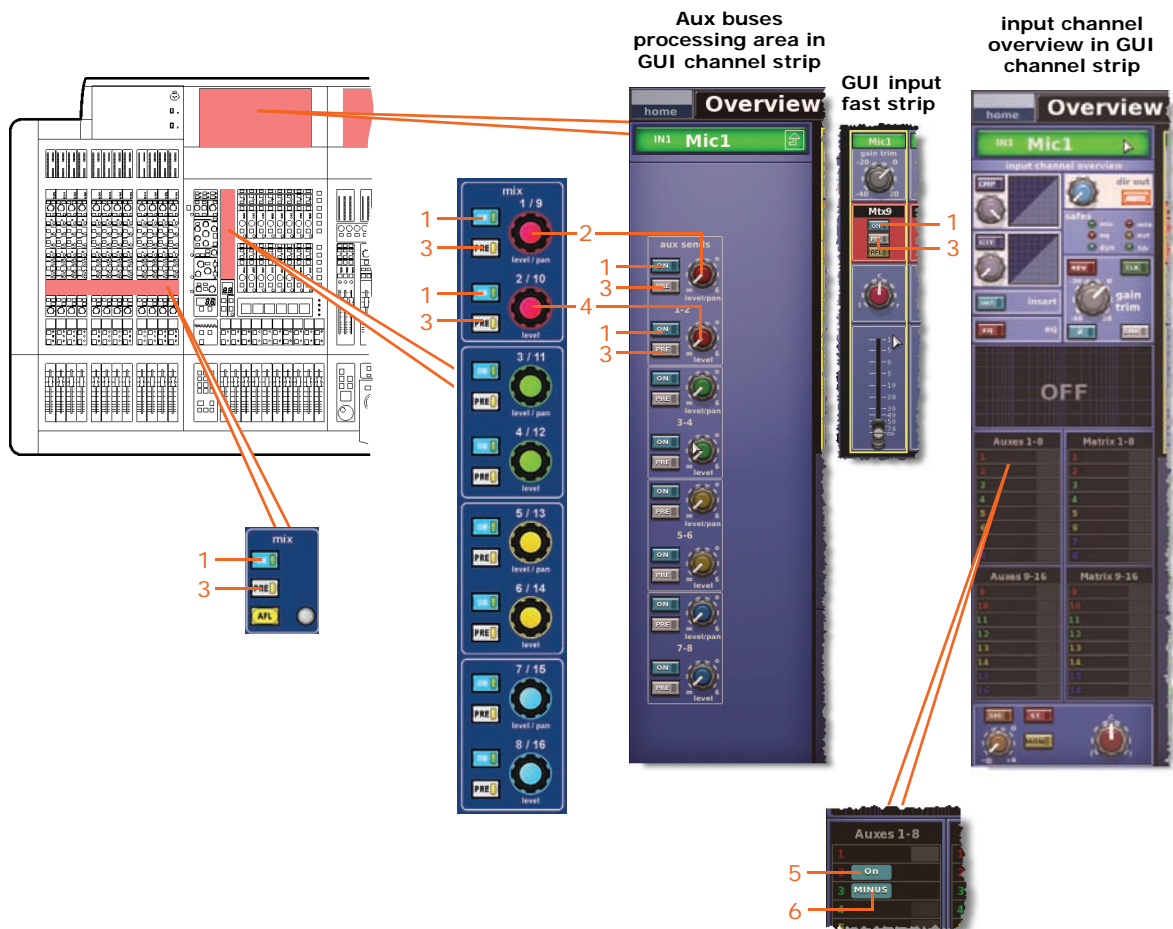

Note: Although only aux sends 1-2 are referenced above, this also applies to all pairs of aux and matrix sends.

Item	Control	Parameter
1	ON switch	Bus send on/off
2	level/pan control knob	Bus level, or pan when bus is linked. (When sending onto a stereo bus the send pan controls are not linked.)
3	PRE switch	Pre-fader on/off
4	level control knob	Bus level
5	On switch	Aux bus send on/off — only available when aux bus is in group mode
6	MINUS switch	Aux bus send mute on/off — only available when aux bus is in mix minus mode

Master routing

The following diagram shows the parameters of the master routing affected by stereo linking.

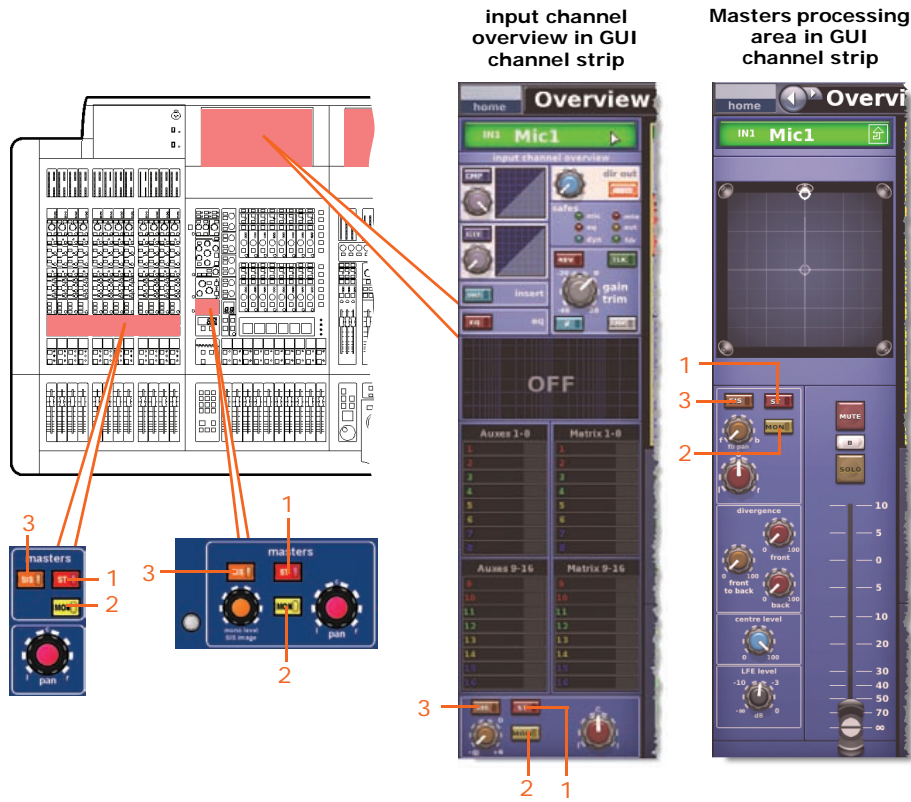

<i>Item</i>	<i>Control</i>	<i>Parameter</i>
1	ST switch	Stereo on/off
2	MON switch	Mono on/off
3	SIS switch	Spatial imaging system on/off

Fader

The following diagram shows the fader parameters affected by stereo linking.

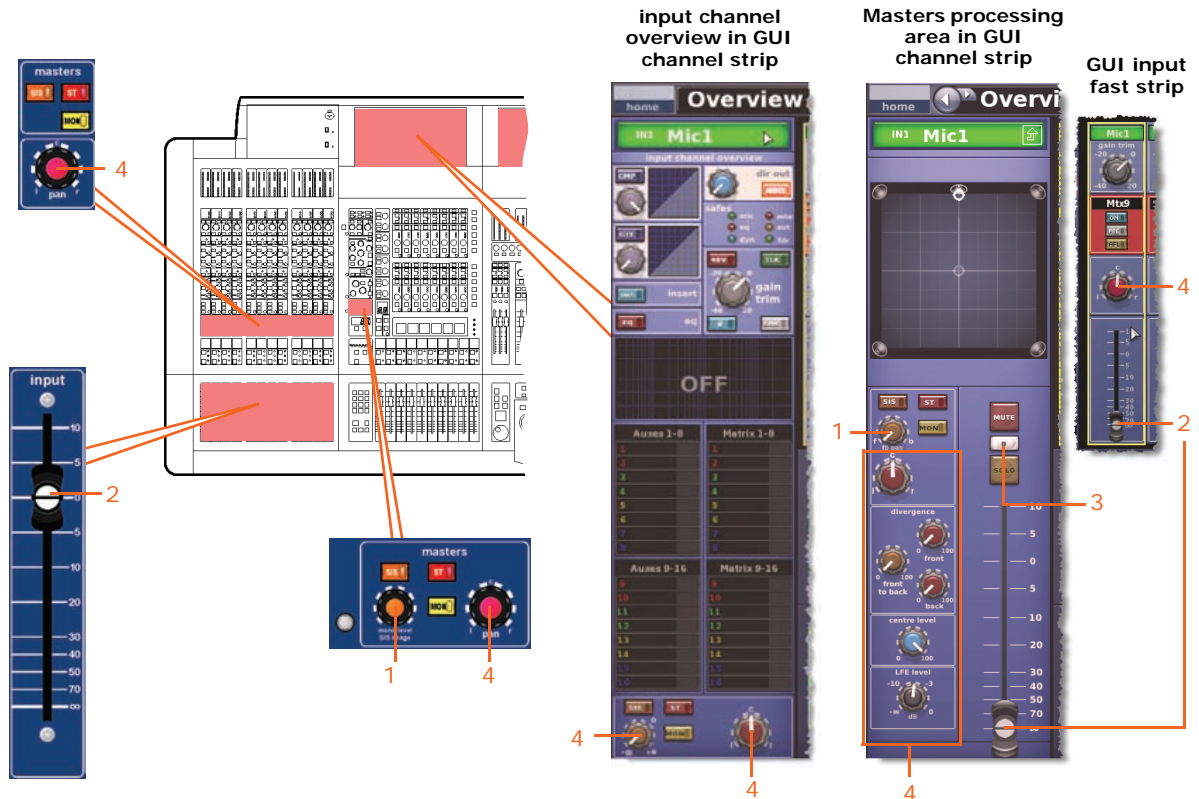

Item	Control	Parameter
1	mono level/SIS image control knob	Mono send level. (Only linked when SIS is out on both channels and surround mode is not selected.)
2	Fader	Fader level
3	B switch	Solo B in/out
4	Panning control knobs	Surround panning (includes all surround sound parameters)

Delay

The following diagram shows the delay parameters affected by stereo linking.

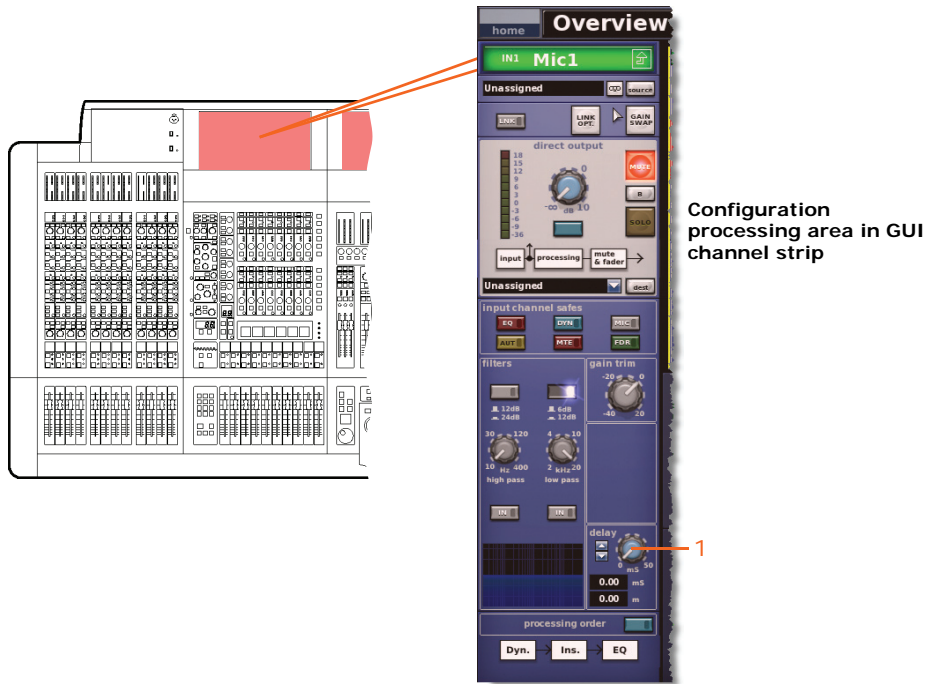

<i>Item</i>	<i>Control</i>	<i>Parameter</i>
1	delay control knob	Delay time

Aux

This section shows the linked parameters of the aux channels.

Input controls

The following diagram shows the input control parameters that are linked across the channel pair.

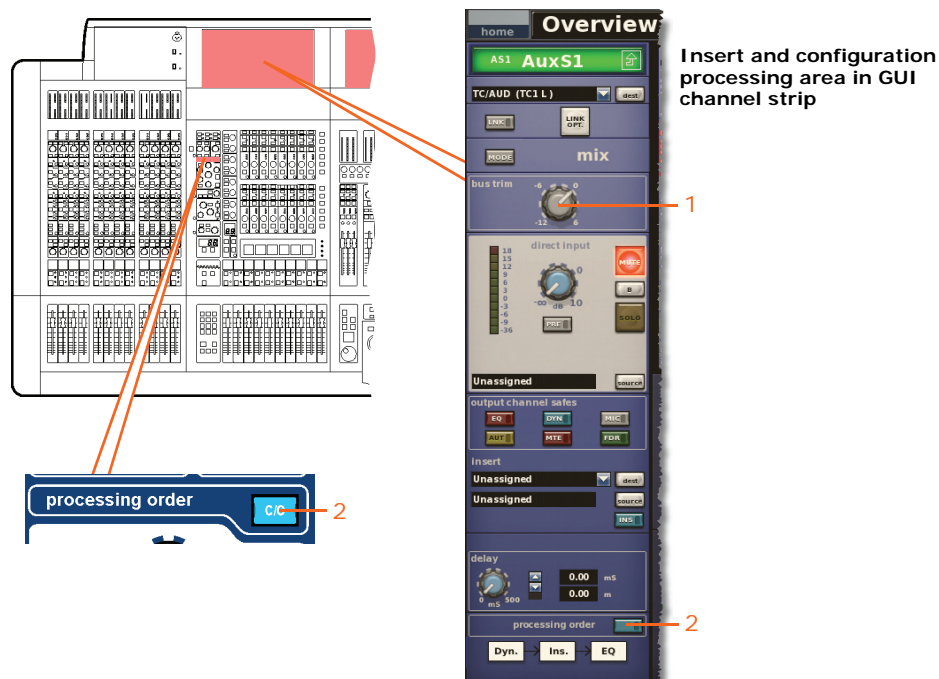

<i>Item</i>	<i>Control</i>	<i>Parameter</i>
1	bus trim control knob	Bus trim level
2	C/O switch	Order of processing: Dyn. → Ins. → EQ or EQ → Ins. → Dyn.

Direct output

Not applicable.

Direct input

The following diagram shows the direct input control parameters that are linked across the channel pair.

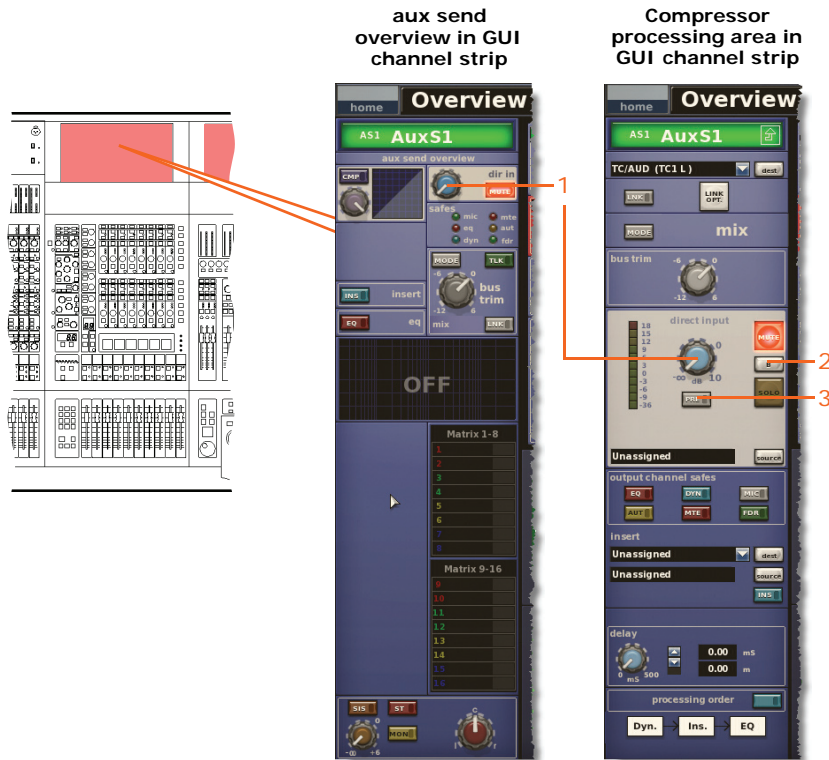

Item	Control	Parameter
1	Control knob	Direct input level
2	B switch	Direct input solo B on/off
3	PRE switch	Direct input pre- in/out

Filters

Not applicable.

Dynamics

The following diagram shows the compression parameters of the dynamics section affected by stereo linking. Only corrective compressor shown below, but this is typically the same for the other compressor modes.

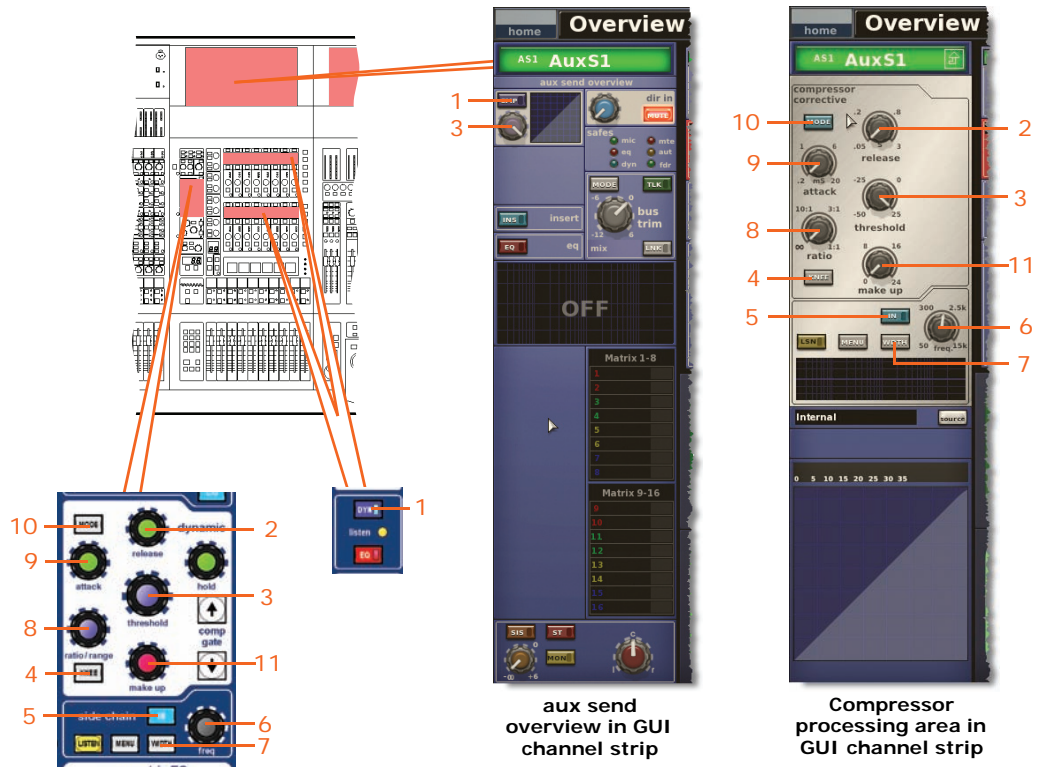

Note: Only the corrective compressor is shown above, but this is typically the same for the other compressor modes (adaptive, creative, vintage and shimmer).

Item	Control	Parameter
1	DYN/[CMP] switch	Compressor on/off
2	release control knob	Compressor release
3	threshold control knob	Compressor threshold
4	KNEE pushbutton	Compressor knee: hard, medium or soft
5	IN switch	Compressor sidechain in/out
6	freq. control knob	Compressor sidechain frequency
7	WIDTH pushbutton	Compressor sidechain width: 2 Oct, 1 Oct or 0.3 Oct
8	ratio/range/[ratio] control knob	Compressor ratio
9	attack control knob	Compressor attack
10	MODE pushbutton	Compressor mode: corrective, adaptive, creative, vintage or shimmer
11	make up control knob	Compressor gain

Insert

The following diagram shows the parameters of the insert section affected by stereo linking.

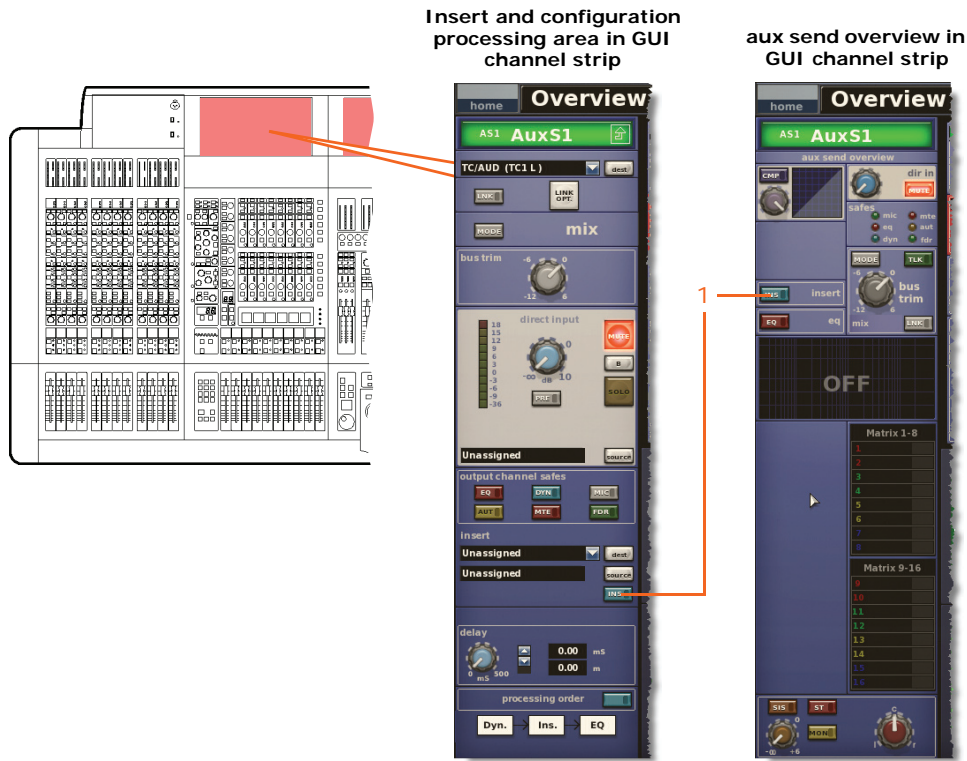

Item	Control	Parameter
1	INS switch	Insert in/out

EQ

The following diagram shows the EQ and GEQ parameters affected by stereo linking.

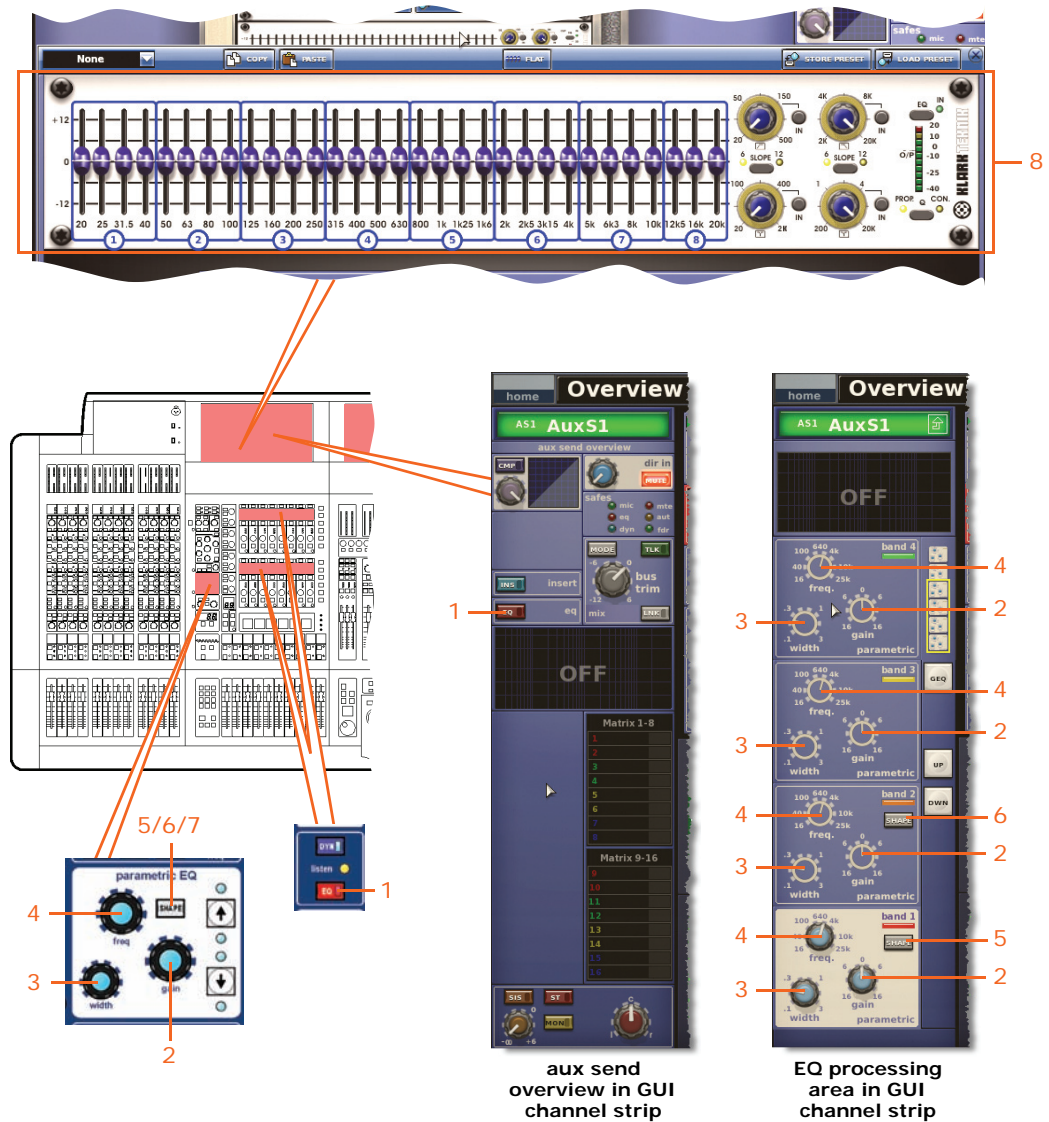

Item	Control	Parameter
1	EQ switch	EQ on/off
2	gain control knob	EQ gain level
3	width control knob	EQ width
4	freq control knob	EQ frequency
5	SHAPE switch	Band 1 shelving mode: bell, warm, high pass 6dB or high pass 12dB
6	SHAPE switch	Band 2 shelving mode: bell or high pass 24dB

Item	Control	Parameter
7*	SHAPE switch	Band 6 shelving modes: bell, soft, low pass 6dB or low pass 12dB
8	GEQ	All GEQ parameters. (GEQ parameters linked when both linked channels have a GEQ assigned to them.)

* Not shown in diagram.

Note: Although band 6 is not shown above, the items in the table also apply. Band 6 has items 2, 3 and 4, and also includes item 7.

Bus sends

The following diagram shows the bus sends affected by stereo linking.

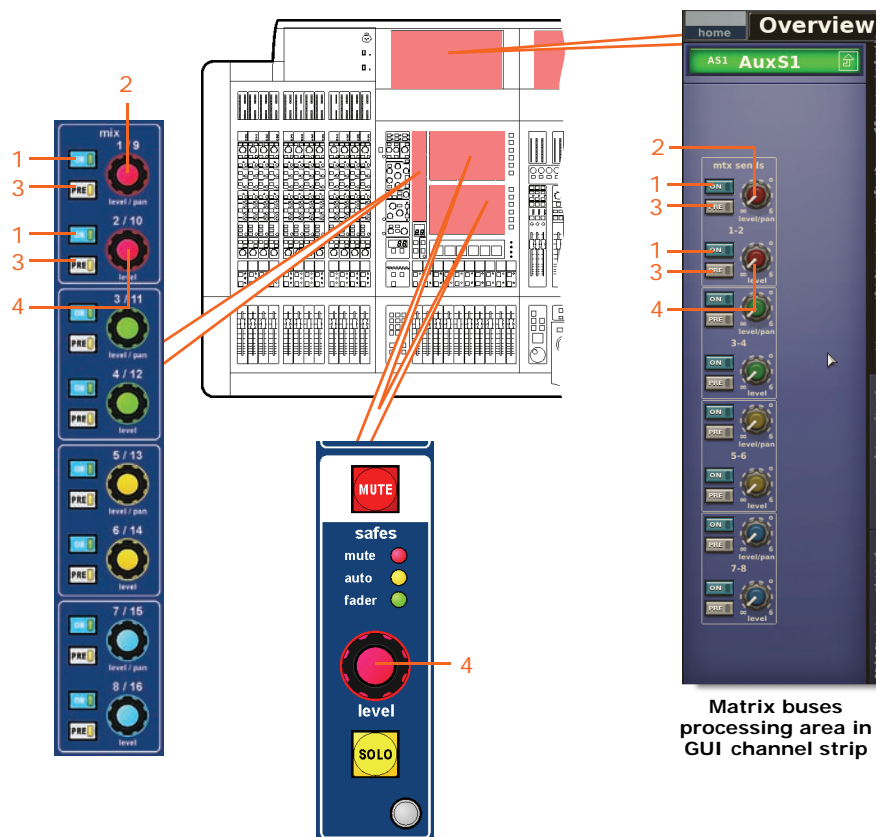

Matrix buses processing area in GUI channel strip

Note: Although only matrix sends 1-2 are referenced above, this also applies to all pairs of matrix sends.

Item	Control	Parameter
1	ON switch	Matrix bus send on/off
2	level/pan control knob	Bus level, or pan when bus is linked. (The pans are not linked, only the sends levels are linked.)
3	PRE switch	Pre-fader on/off
4	level control knob	Bus level

Master routing

The following diagram shows the master routing parameters affected by stereo linking.

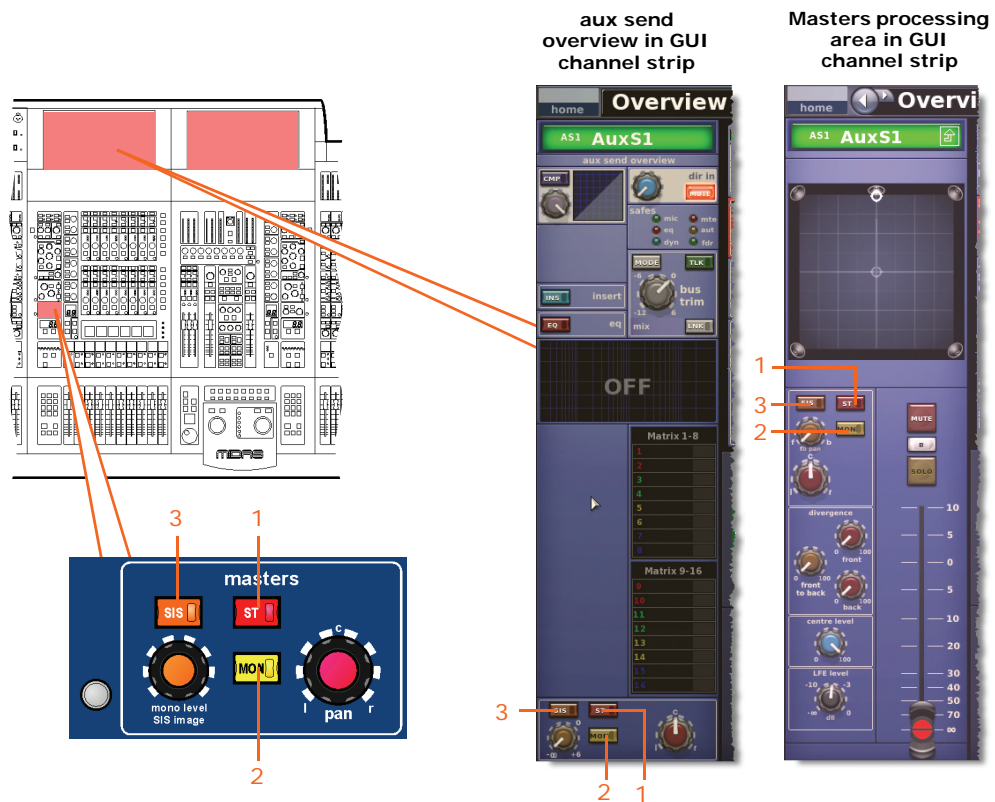

Item	Control	Parameter
1	ST switch	Stereo on/off
2	MON switch	Mono on/off
3	SIS switch	Spatial imaging system on/off

Fader

The following diagram shows the fader parameters affected by stereo linking.

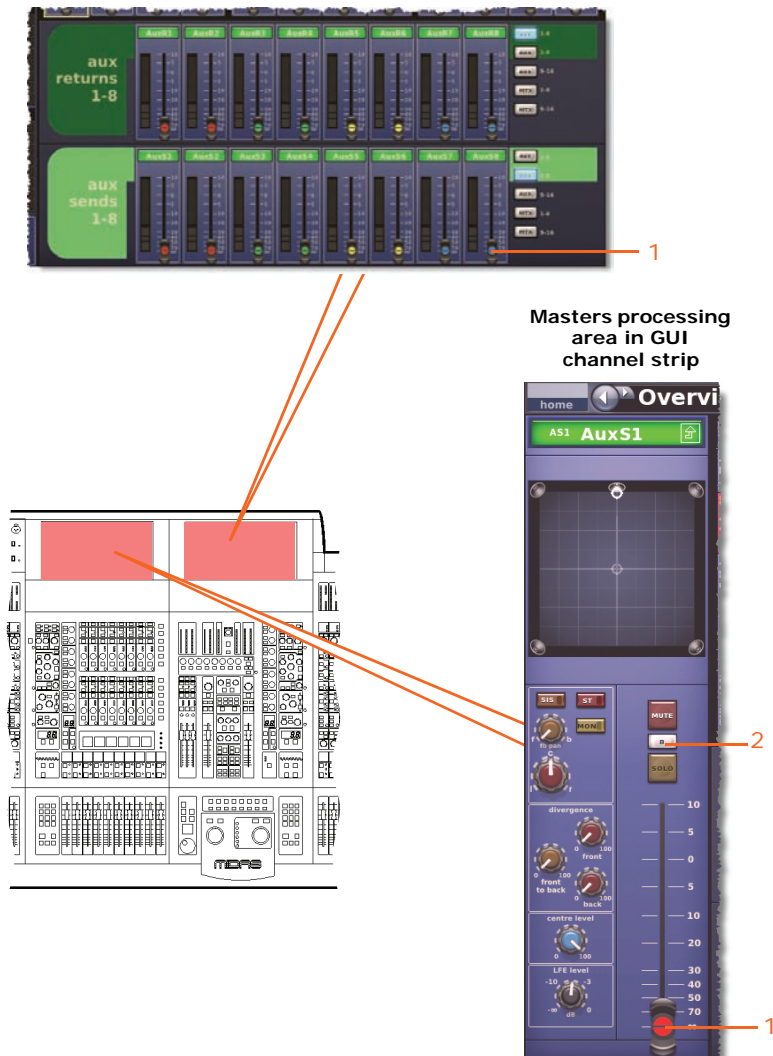

<i>Item</i>	<i>Control</i>	<i>Parameter</i>
1	Fader	Level
2	B switch	Solo B on/off

Delay

The following diagram shows the delay parameters affected by stereo linking.

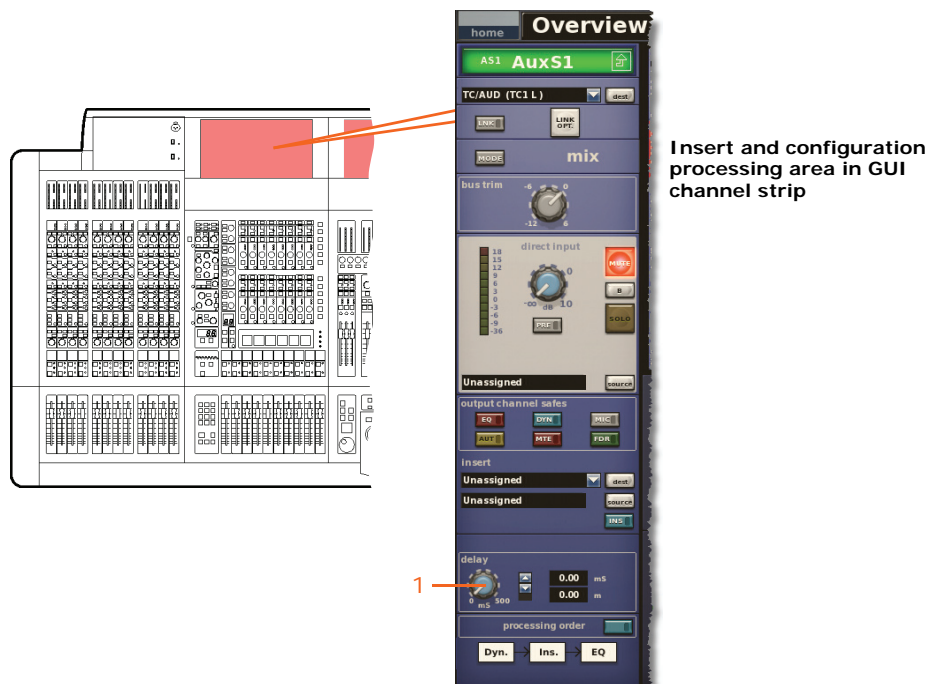

<i>Item</i>	<i>Control</i>	<i>Parameter</i>
1	delay control knob	Delay time

Return

This section shows the linked parameters of the return channels.

Input controls

The following diagram shows the parameters of the input controls affected by stereo linking.

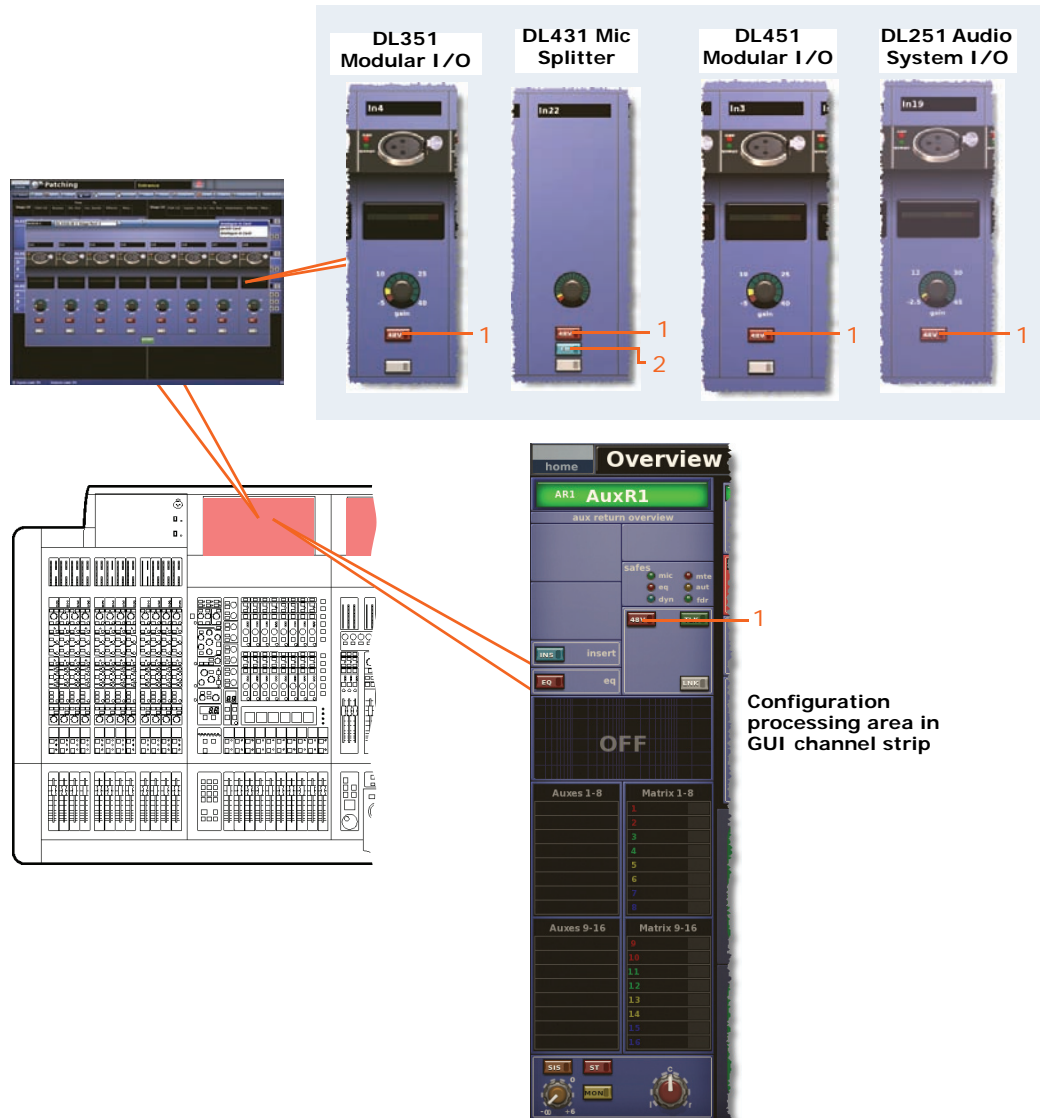

Item	Control	Parameter
1	48V switch*	48V phantom voltage in/out
2	Flt switch*	30Hz filter in/out

* Applies to tape and primary inputs.

Direct output

Not applicable.

Direct input

Not applicable.

Filters

Not applicable.

Dynamics

Not applicable.

Insert

Not applicable.

EQ

Not applicable.

Bus sends

The following diagram shows the bus sends affected by stereo linking.

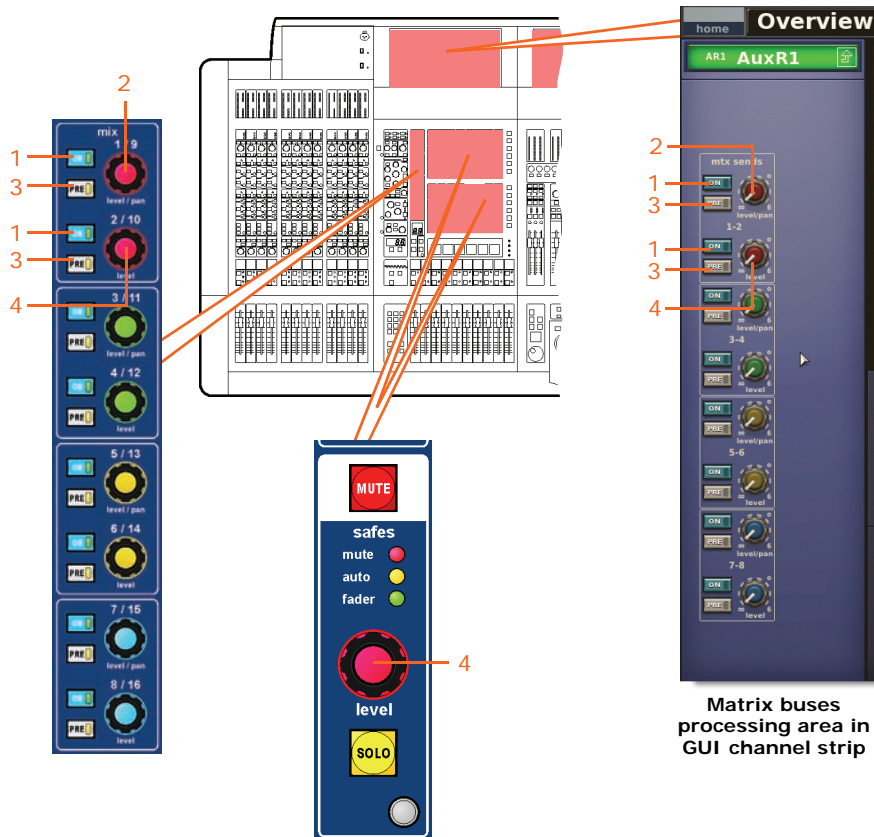

Note: Although only matrix sends 1-2 are referenced above, this also applies to all pairs of matrix sends.

Item	Control	Parameter
1	ON switch	Matrix bus send on/off
2	level/pan control knob	Bus level, or pan when bus is linked. (The pans are not linked, only the sends levels are linked.)
3	PRE switch	Pre-fader on/off
4	level control knob	Bus level

Master routing

The following diagram shows the parameters of the master routing affected by stereo linking.

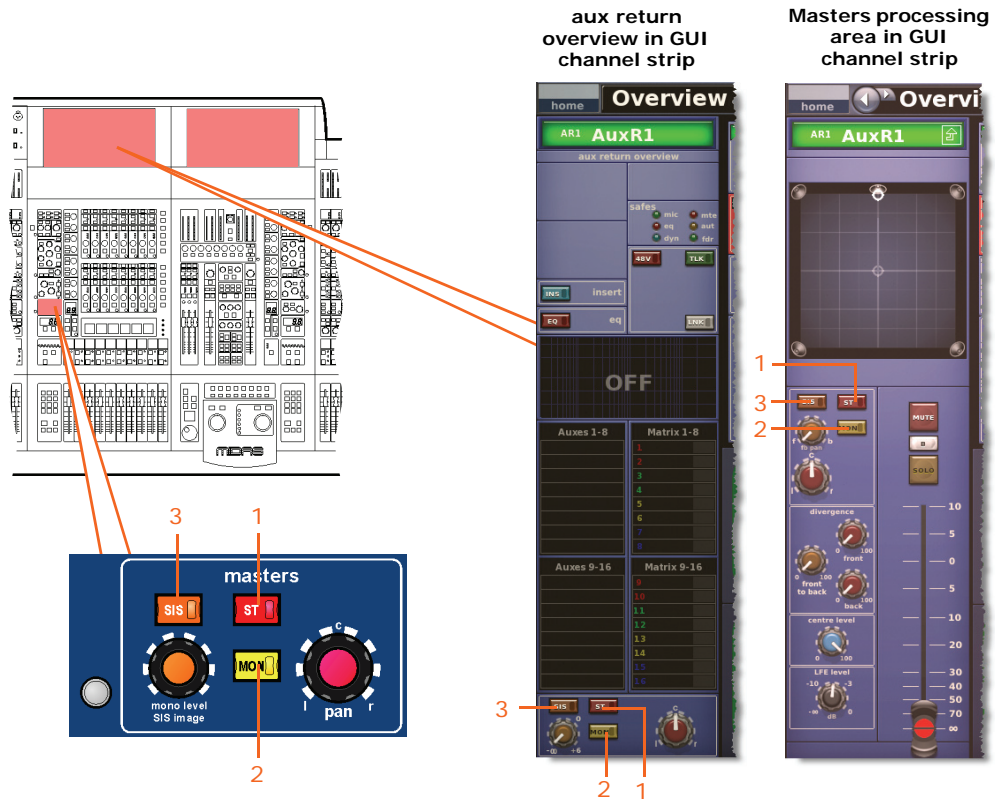

Item	Control	Parameter
1	ST switch	Stereo on/off
2	MON switch	Mono on/off
3	SIS switch	Spatial imaging system on/off

Fader

The following diagram shows the fader parameters affected by stereo linking.

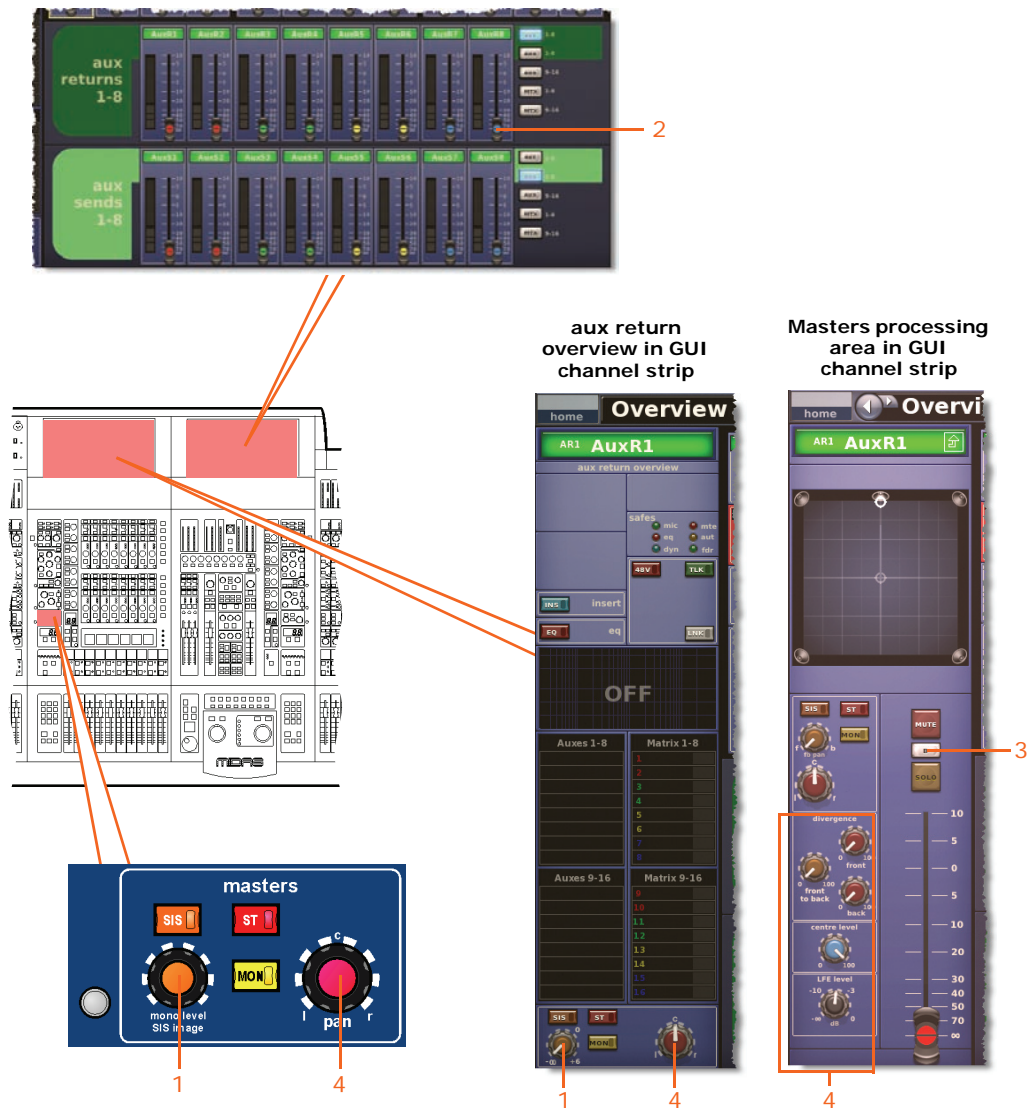

Item	Control	Parameter
1	mono level/SIS image control knob	Mono send level. (Only linked when SIS is out on both channels and surround mode is off.)
2	Fader	Level
3	B switch	Solo B on/off
4	Surround control knobs	Surround panning levels

Delay

Not applicable.

Matrix

This section shows the linked parameters of the matrix channels.

Input controls

The following diagram shows the input control parameters that are linked across a channel pair.

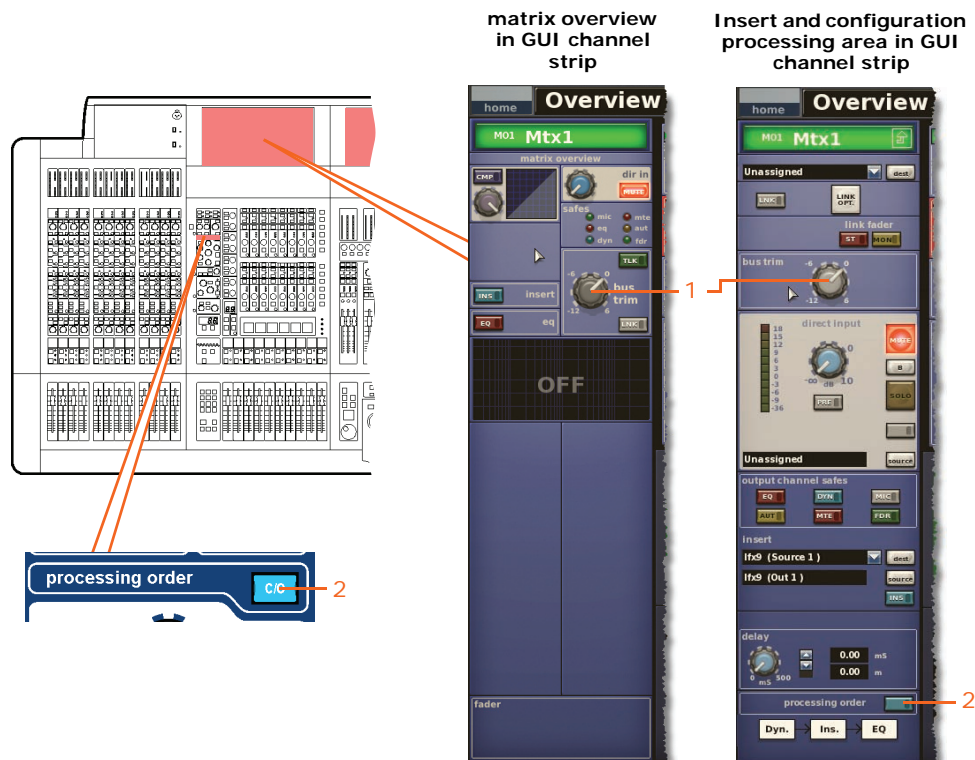

Item	Control	Parameter
1	bus trim control knob	Bus trim level
2	C/O switch	Order of processing: Dyn. → Ins. → EQ or EQ → Ins. → Dyn.

Direct output

Not applicable.

Direct input

The following diagram shows the direct input control parameters that are linked across a channel pair.

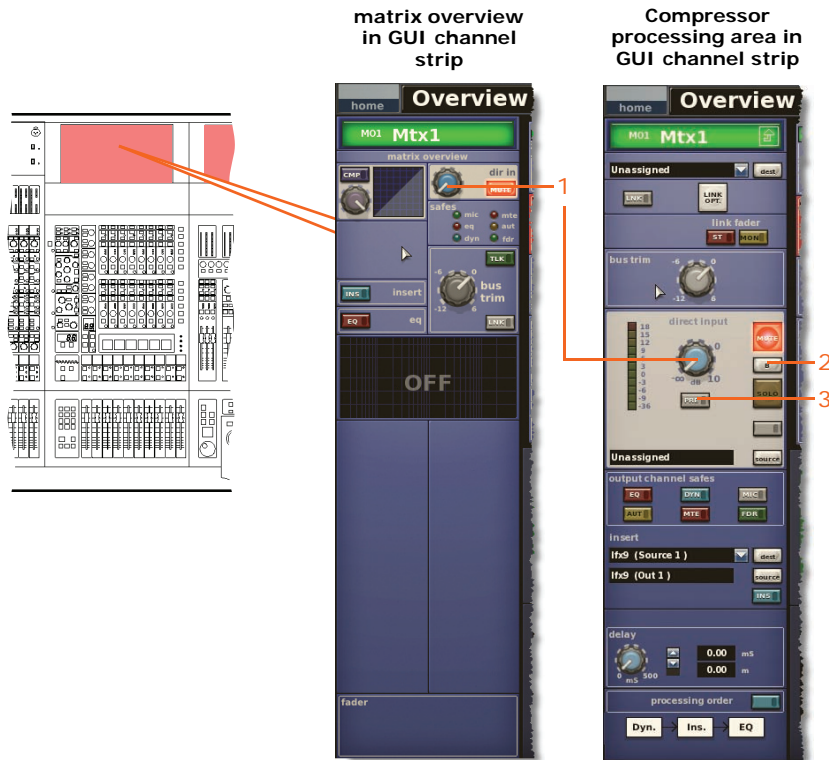

Item	Control	Parameter
1	Control knob	Direct input level
2	B switch	Direct input solo B on/off
3	PRE switch	Direct input pre- in/out

Filters

Not applicable.

Dynamics

The following diagram shows the compressor parameters affected by stereo linking.

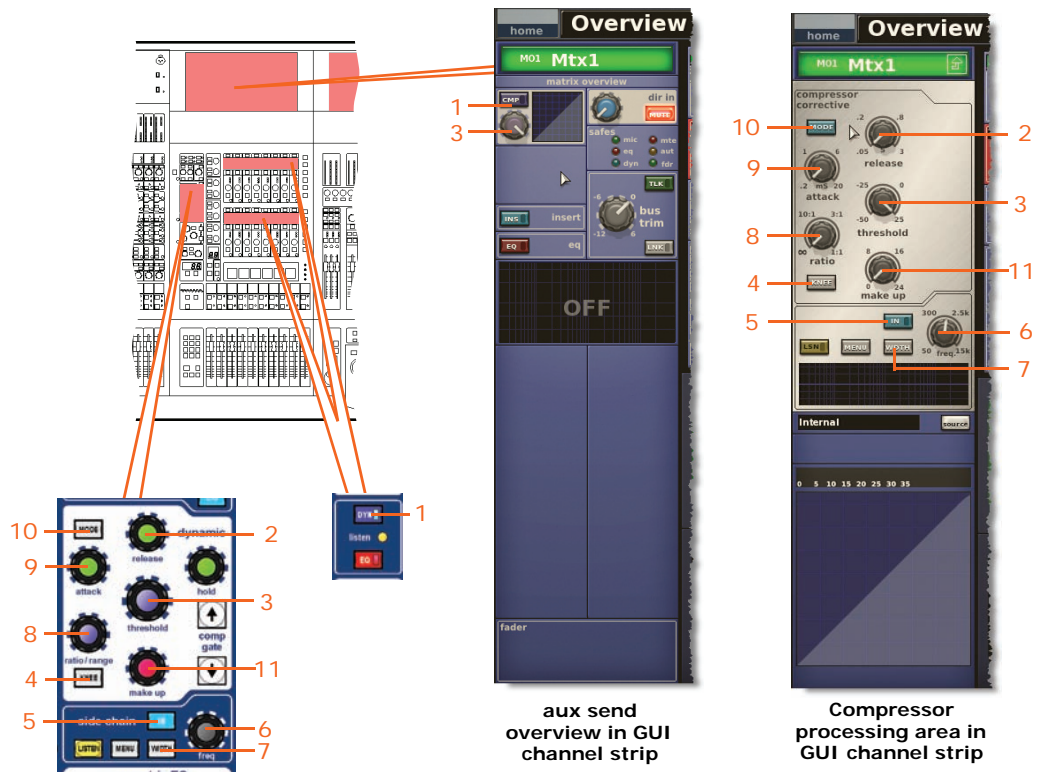

Note: Only the corrective compressor is shown above, but this is typically the same for the other compressor modes (adaptive, creative, vintage and shimmer).

Item	Control	Parameter
1	DYN/[CMP] switch	Compressor on/off
2	release control knob	Compressor release
3	threshold control knob	Compressor threshold
4	KNEE pushbutton	Compressor knee: hard, medium or soft
5	IN switch	Compressor sidechain in/out
6	freq control knob	Compressor sidechain frequency
7	WIDTH pushbutton	Compressor sidechain width: 2 Oct, 1 Oct or 0.3 Oct
8	ratio range/[ratio] control knob	Compressor ratio
9	attack control knob	Compressor attack
10	MODE pushbutton	Compressor mode: corrective, adaptive, creative, vintage or shimmer
11	make up control knob	Compressor gain

Insert

The following diagram shows the parameters of the insert section affected by stereo linking.

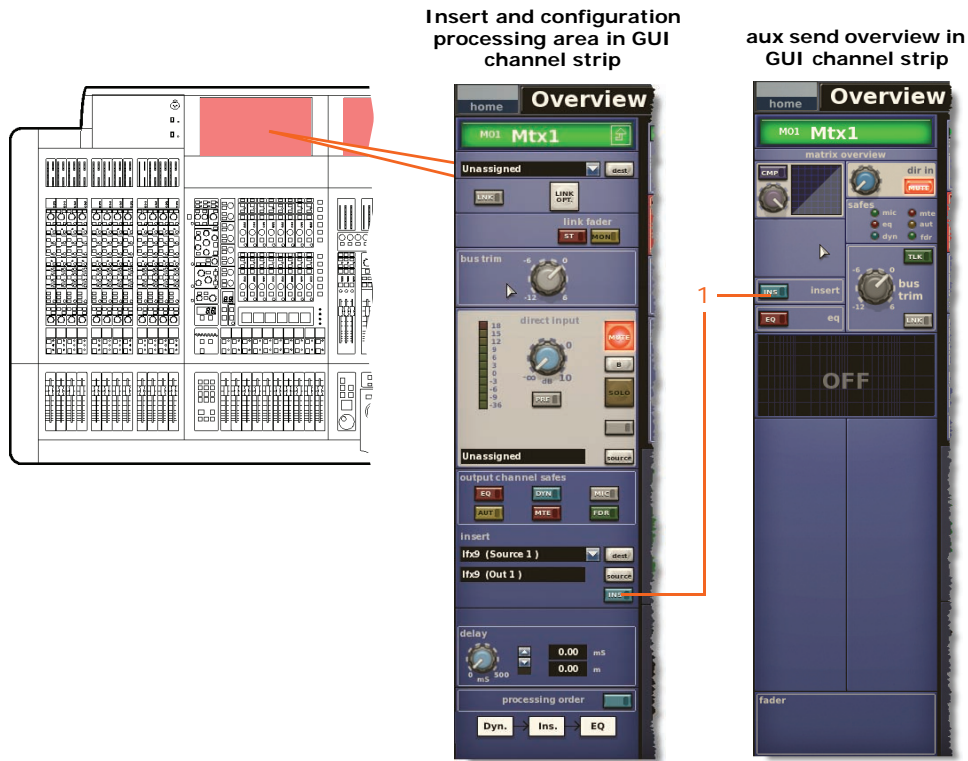

Item	Control	Parameter
1	INS switch	Insert in/out

EQ

The following diagram shows the parameters of the EQ section affected by stereo linking.

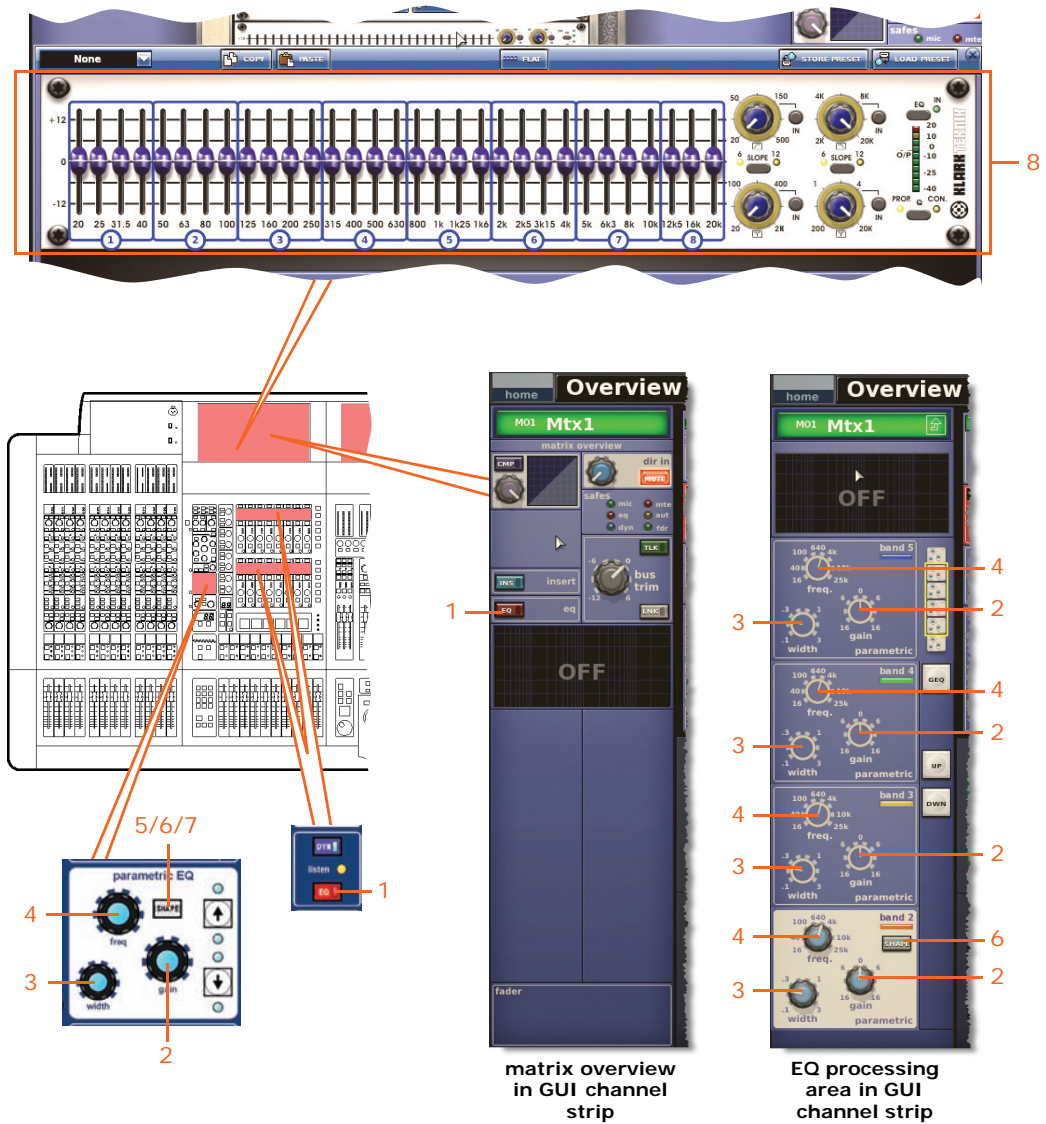

Item	Control	Parameter
1	EQ switch	EQ on/off
2	gain control knob	EQ gain level
3	width control knob	EQ width
4	freq control knob	EQ frequency
5*	SHAPE switch	Band 6 shelving mode: bell, soft, low pass 6dB or low pass 12dB
6	SHAPE switch	Band 2 shelving mode: bell or high pass 24dB

<i>Item</i>	<i>Control</i>	<i>Parameter</i>
7*	SHAPE switch	Band 1 shelving mode: bell, warm, high pass 6dB or high pass 12dB
8	GEQ	All GEQ parameters. (GEQ parameters linked when both linked channels have a GEQ assigned to them.)

* Not shown in diagram.

Note: Although bands 1 and 6 are not shown above, the items in the table also apply. Both bands have items 2, 3 and 4. Band 1 also has item 7, and band 6 also has item 5.

Bus sends

Not applicable.

Master routing

Not applicable.

Fader

The following diagram shows the fader parameters affected by stereo linking.

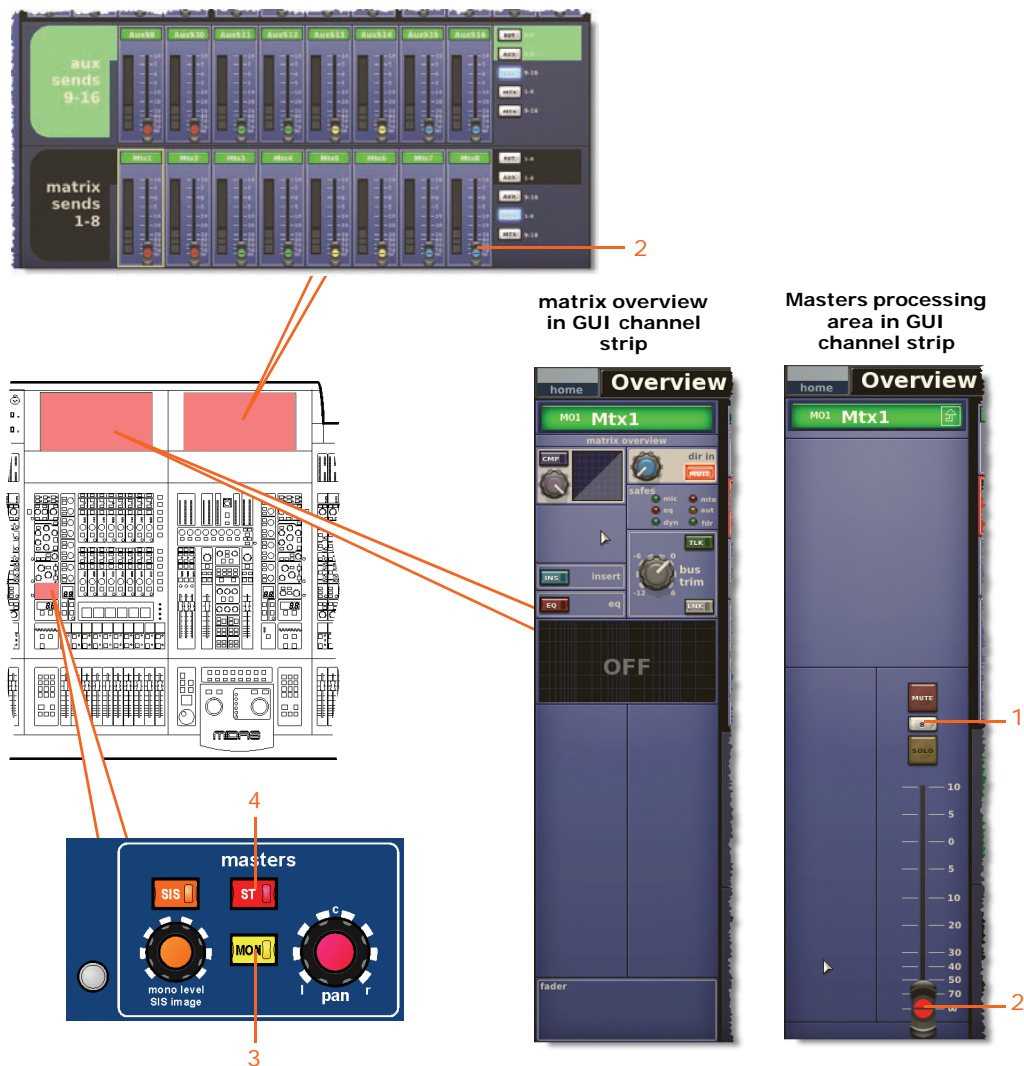

Item	Control	Parameter
1	B switch	Solo B on/off
2	Fader	Level
3	MON switch	Link to mono master fader
4	ST switch	Link to stereo master fader

Delay

The following diagram shows the delay parameters affected by stereo linking.

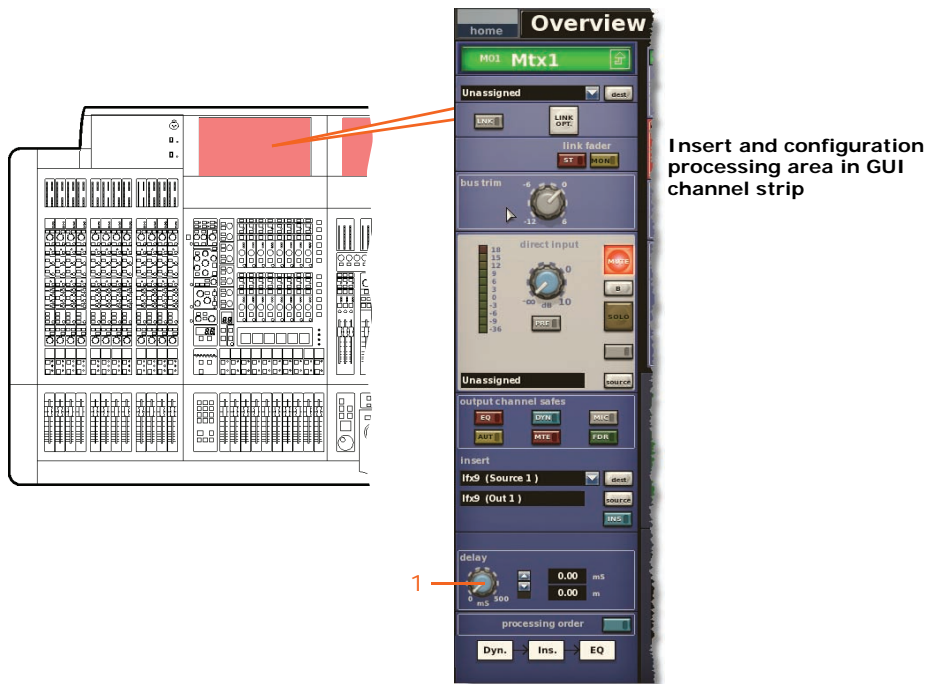

<i>Item</i>	<i>Control</i>	<i>Parameter</i>
1	delay control knob	Delay time

Master

This section shows the linked parameters of the master channels.

Input controls

The following diagram shows the input control parameters that are linked across a channel pair.

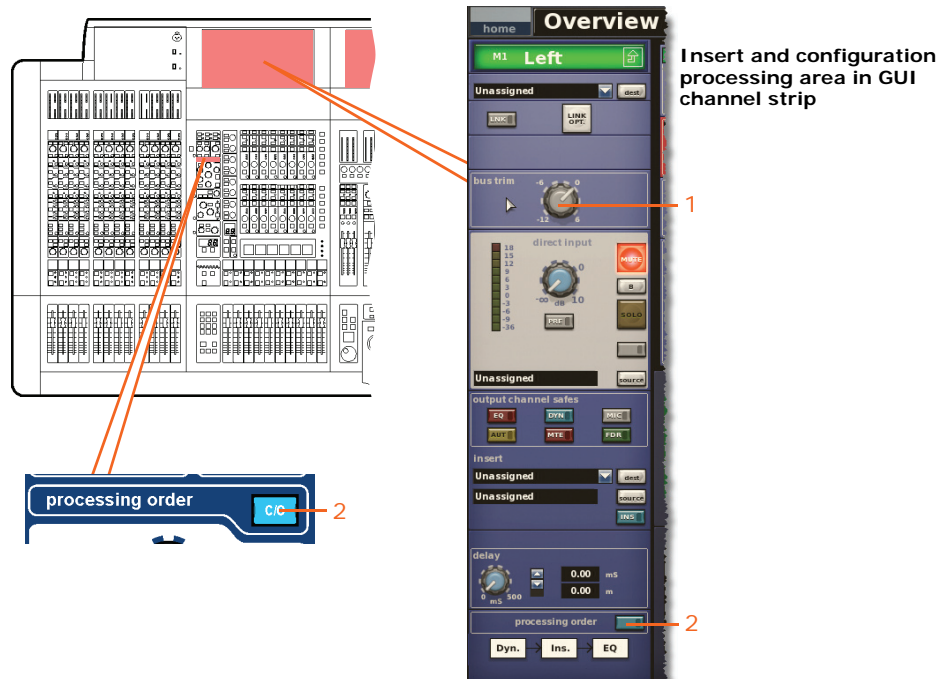

<i>Item</i>	<i>Control</i>	<i>Parameter</i>
1	Control knob	Bus trim level
2	C/O switch	Order of processing: Dyn. → Ins. → EQ or EQ → Ins. → Dyn.

Direct output

Not applicable.

Direct input

The following diagram shows the direct output control parameters that are linked across a channel pair.

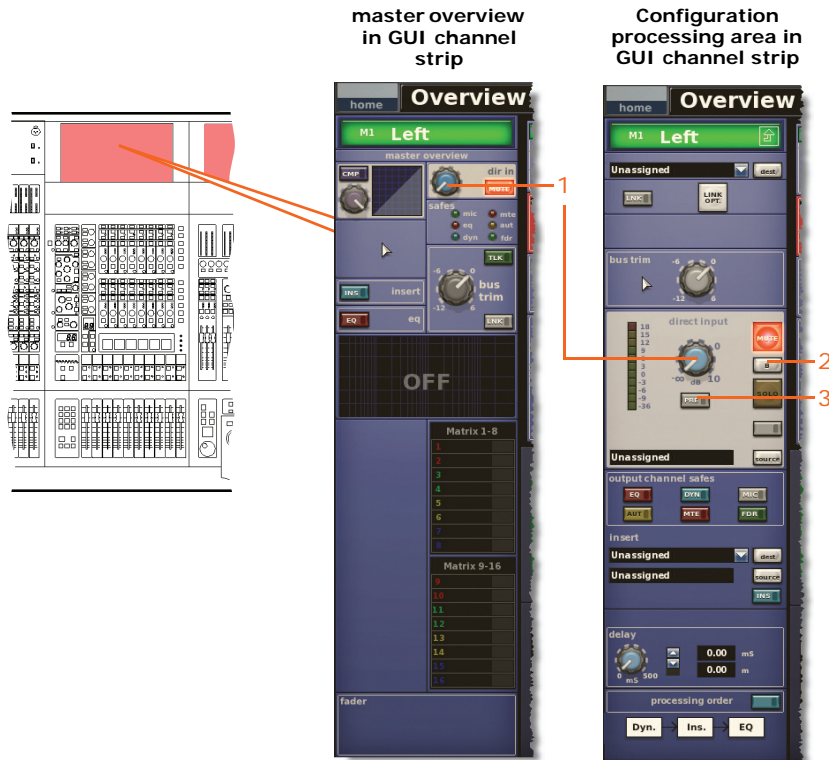

Item	Control	Parameter
1	Control knob	Direct input level
2	B switch	Direct input solo B on/off
3	PRE switch	Direct input pre- in/out

Filters

Not applicable.

Dynamics

The following diagram shows all the compression parameters of the dynamics section affected by stereo linking.

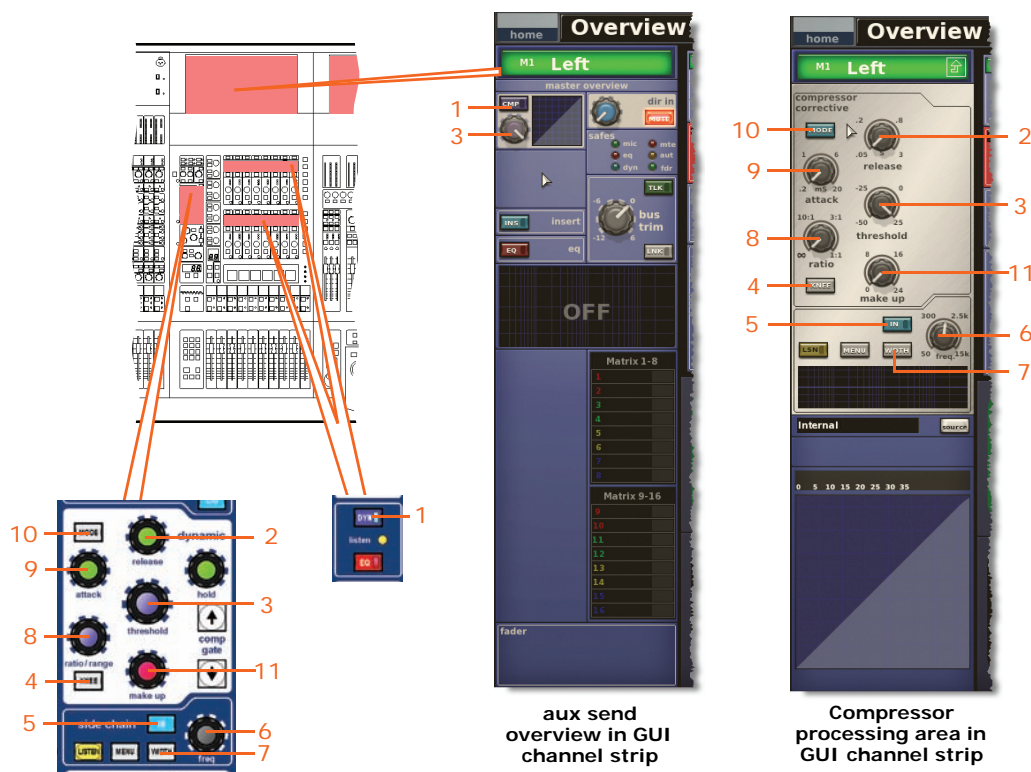

Note: Only the corrective compressor is shown above, but this is typically the same for the other compressor modes (adaptive, creative, vintage and shimmer).

Item	Control	Parameter
1	DYN/[CMP] switch	Compressor on/off
2	release control knob	Compressor release
3	threshold control knob	Compressor threshold
4	KNEE pushbutton	Compressor knee: hard, medium or soft
5	IN switch	Compressor sidechain in/out
6	freq control knob	Compressor sidechain frequency
7	WIDTH pushbutton	Compressor sidechain width: 2 Oct, 1 Oct or 0.3 Oct
8	ratio range/[ratio] control knob	Compressor ratio
9	attack control knob	Compressor attack
10	MODE pushbutton	Compressor mode: corrective, adaptive, creative, vintage or shimmer
11	make up control knob	Compressor gain

Insert

The following diagram shows the parameters of the insert section affected by stereo linking.

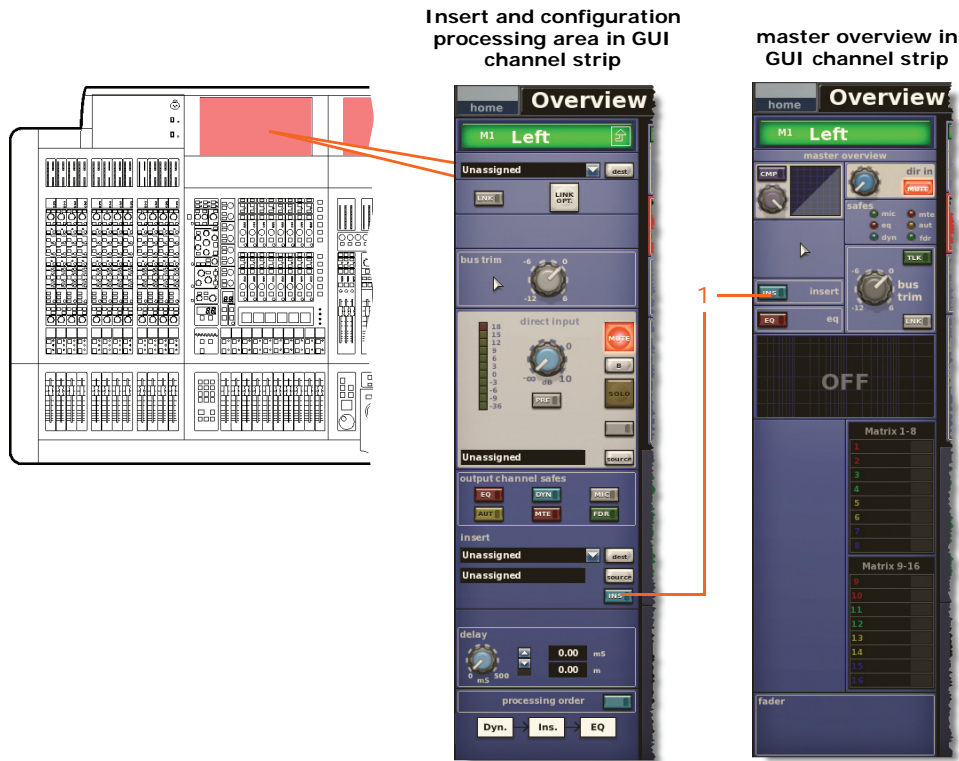

Item	Control	Parameter
1	INS switch	Insert in/out

EQ

The following diagram shows the parameters of the EQ section affected by stereo linking.

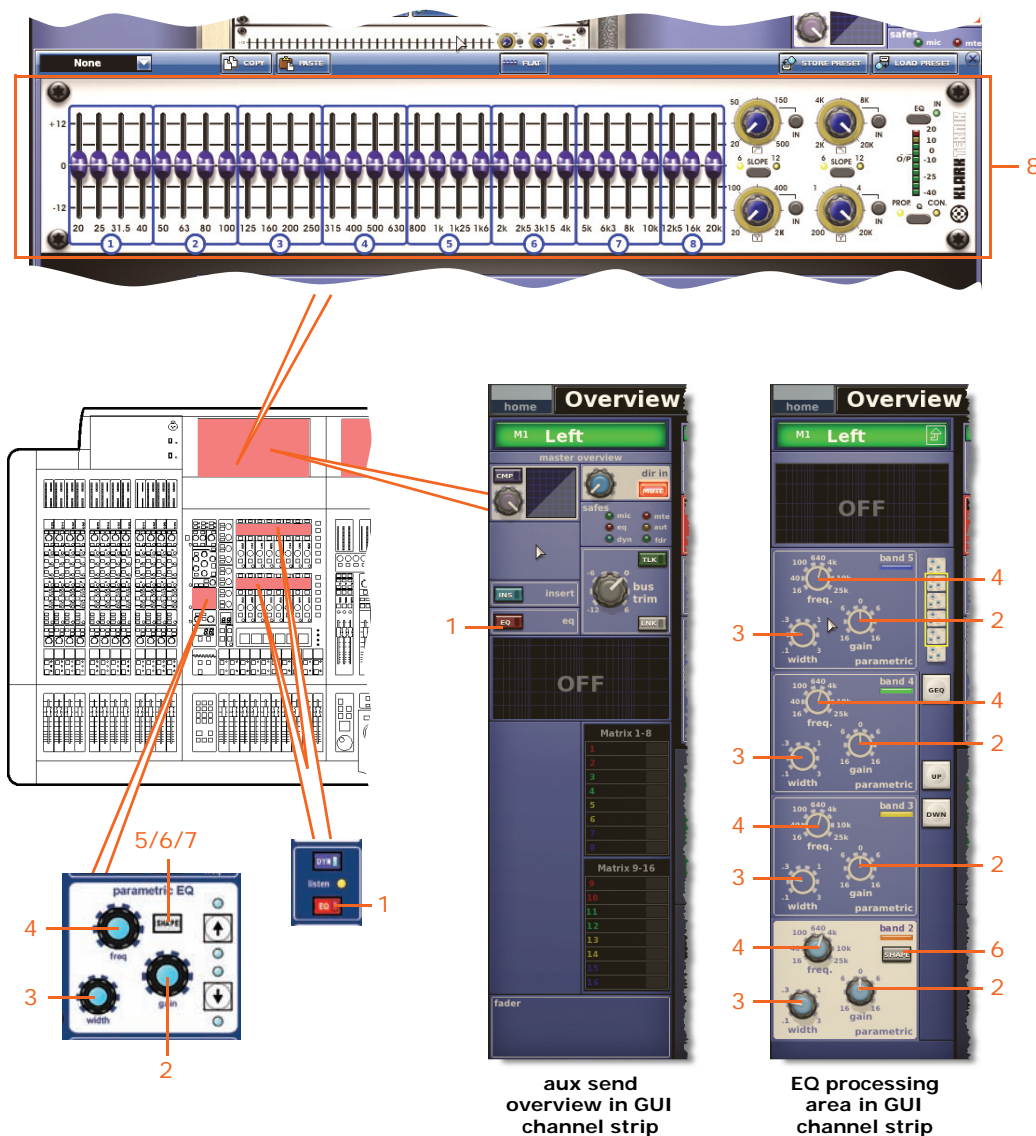

Item	Control	Parameter
1	EQ switch	EQ on/off
2	gain control knob	EQ gain level
3	width control knob	EQ width
4	freq control knob	EQ frequency
5*	SHAPE switch	Band 6 shelving mode: bell, soft, low pass 6dB or low pass 12dB
6	SHAPE switch	Band 2 shelving mode: bell or high pass 24dB

Item	Control	Parameter
7*	SHAPE switch	Band 1 shelving mode: bell, warm, high pass 6dB or high pass 12dB
8	GEQ	All GEQ parameters. (GEQ parameters linked when both linked channels have a GEQ assigned to them.)

* Not shown in diagram.

Note: Although bands 1 and 6 are not shown above, the items in the table also apply. Both bands have items 2, 3 and 4. Band 1 also has item 7, and band 6 also has item 5.

Bus sends

Not applicable.

Master routing

Not applicable.

Fader

The following diagram shows the fader parameters affected by stereo linking.

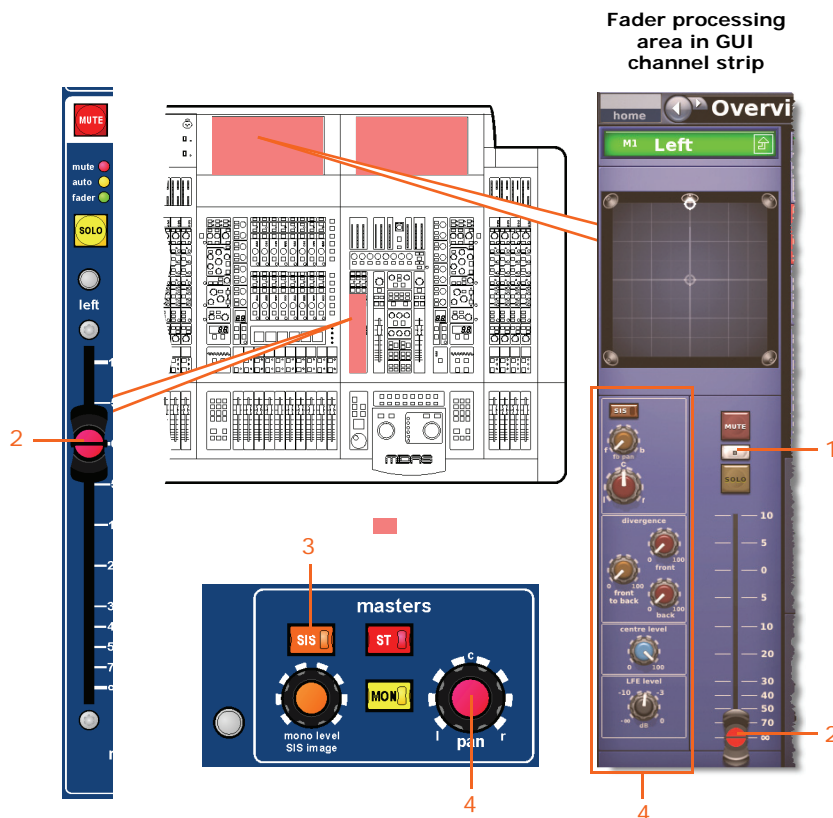

Item	Control	Parameter
1	B switch	Solo B on/off
2	Fader	Level

<i>Item</i>	<i>Control</i>	<i>Parameter</i>
3	SIS switch	Route to surround on/off
4	Surround control knobs	Surround panning levels

Delay

The following diagram shows the delay parameters affected by stereo linking.

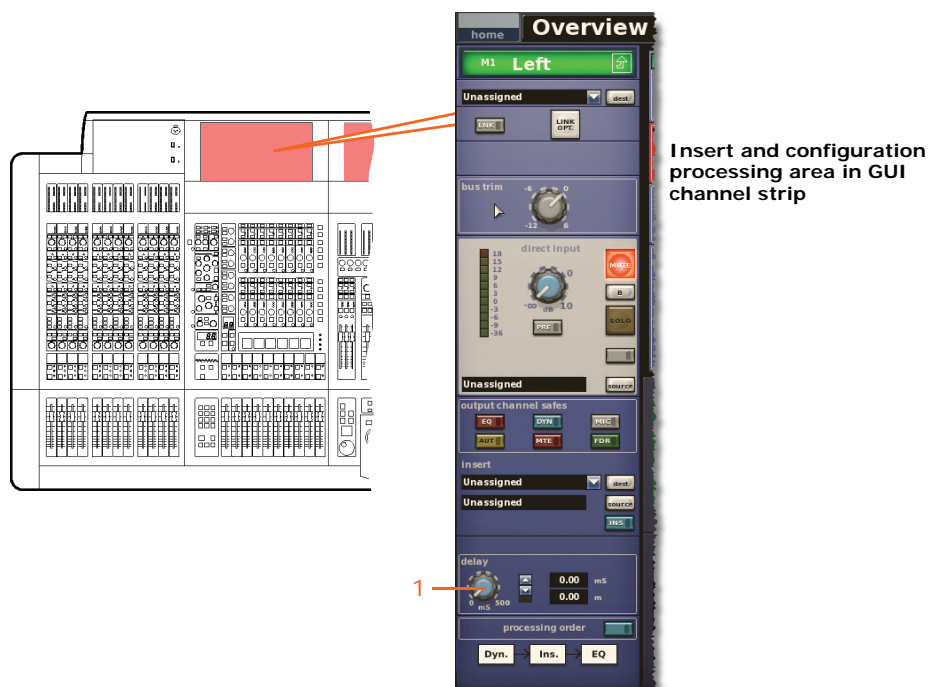

<i>Item</i>	<i>Control</i>	<i>Parameter</i>
1	delay control knob	Delay time

Appendix P: Parameters Copied Through Scenes

This appendix shows the parameters per section — selected from the **Sections** panel in the **Show Editor** screen — that can be copied through scenes.

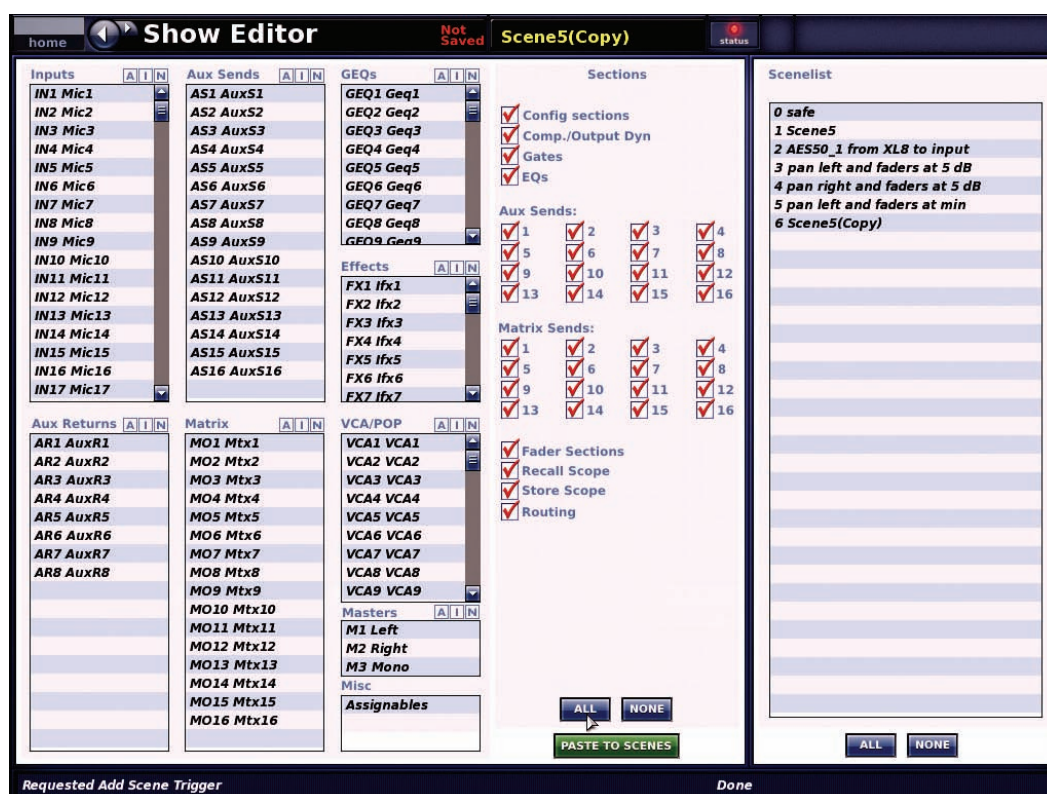

Typical **Show Editor** screen

Note: Some of the GUI displays in this appendix may look slightly different to the ones on the PRO Series Control Centre you are using, as they may be taken from a different type of PRO Series Live Audio System. For example, the PRO3 doesn't have a **Matrix 9 - 16** section in the GUI channel strip. However, all of the parameters copied through scenes are still the same.

Inputs (input channels)

This section shows you which parameters for each of the input channels are affected by copy through scenes.

Config sections

The following diagram shows the input channel configuration processing area parameters copied through scenes.

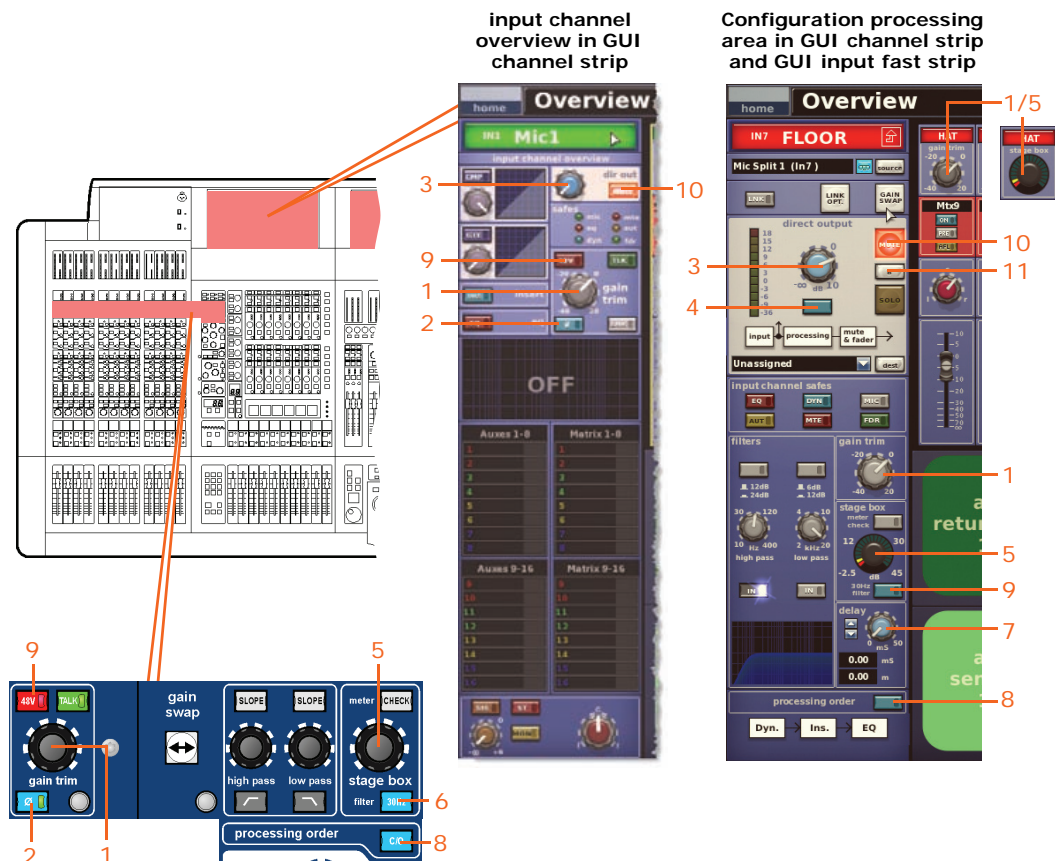

Item	Control	Parameter
1	gain trim control knob	Digital trim level
2	Ø switch	Phase on/off switch
3	Control knob	Direct output level
4	MODE switch	Direct output tap-off point: "Post-fade and mute", "Pre-mute, pre-processing" and "Pre-mute, post-processing"
5	stage box control knob*	Remote amplifier level
6	30Hz switch*	30Hz filter on/off
7	delay control knob	Delay time
8	C/O switch	Order of processing: Dyn. → Ins. → EQ or EQ → Ins. → Dyn.
9	48V switch*	48V phantom voltage on/off

<i>Item</i>	<i>Control</i>	<i>Parameter</i>
10	MUTE switch	Direct output mute on/off
11	B switch	Direct output solo B on/off

* Applies to primary and tape inputs.

Comp./Output Dyn

The following diagram shows the input channel compressor parameters copied through scenes.

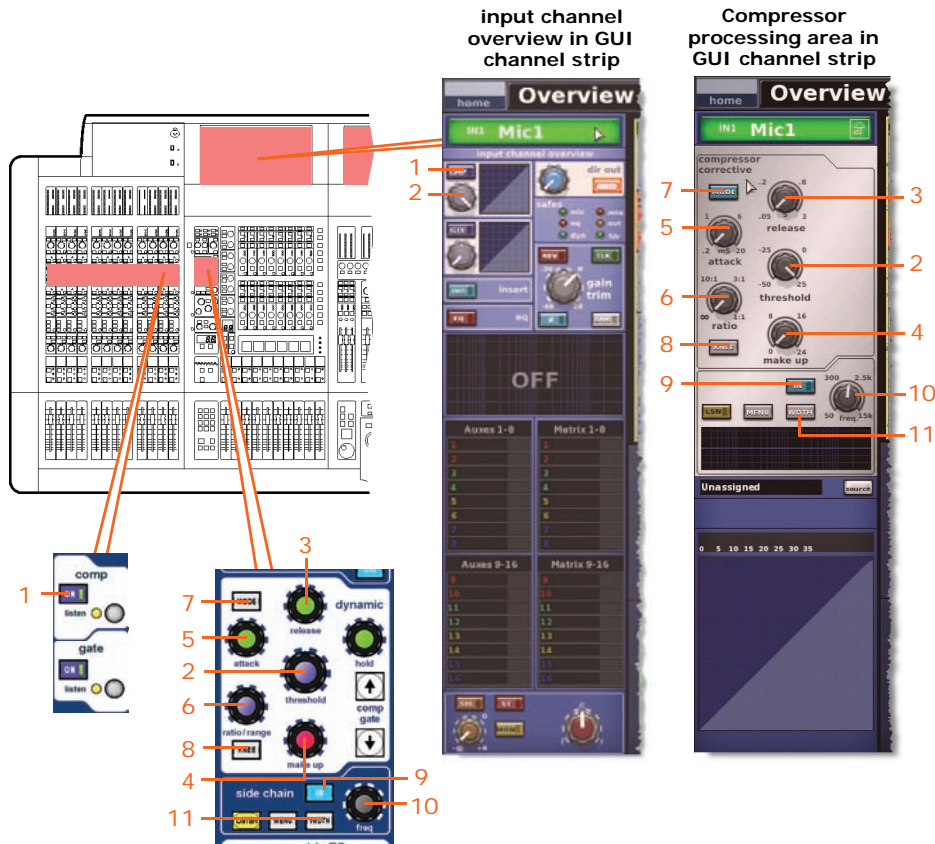

Note: Only the corrective compressor is shown above, but this is typically the same for the other compressor modes (adaptive, creative and vintage).

Item	Control	Parameter
1	ON/[CMP] switch	Compressor on/off
2	threshold control knob	Compressor threshold
3	release control knob	Compressor release
4	make up control knob	Compressor make up gain
5	attack control knob	Compressor attack
6	ratio/range/[ratio] control knob	Compressor ratio
7	MODE pushbutton	Compressor mode: corrective, adaptive, creative or vintage
8	KNEE pushbutton	Compressor knee: hard, medium or soft
9	IN switch	Compressor sidechain in/out

Item	Control	Parameter
10	freq control knob	Compressor sidechain frequency
11	WIDTH pushbutton	Compressor sidechain: 2 Oct, 1 Oct or 0.3 Oct

Gates

The following diagram shows the input channel gate parameters copied through scenes.

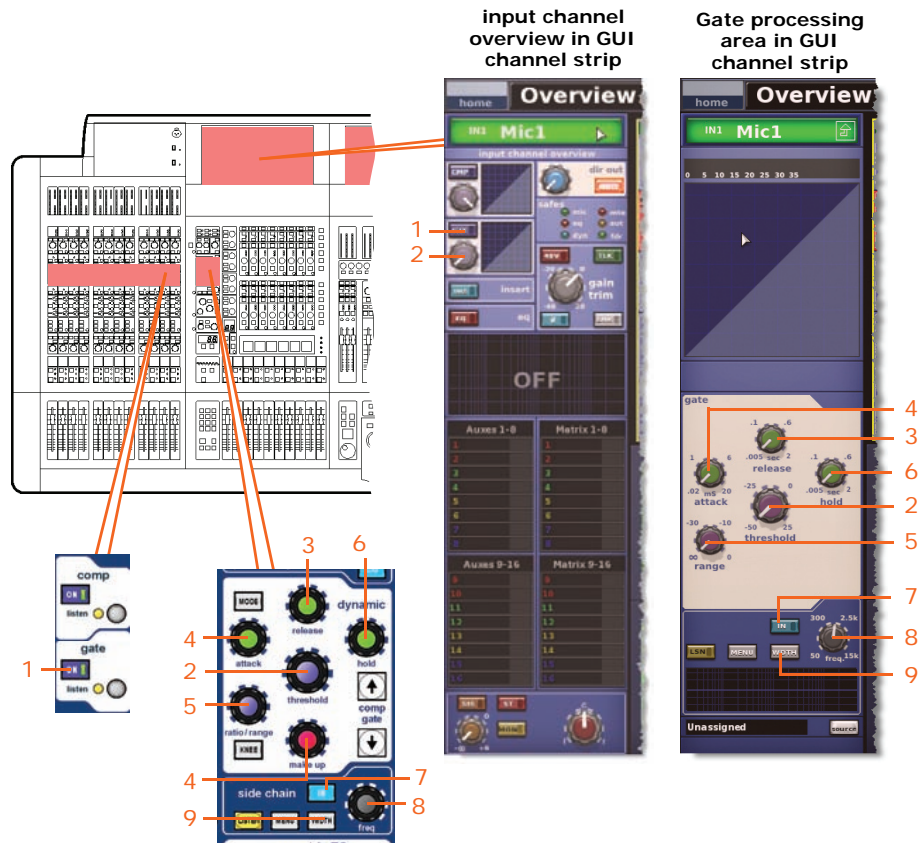

Item	Control	Parameter
1	ON/[GTE] switch	Gate on/off
2	threshold control knob	Gate threshold
3	release control knob	Gate release
4	attack control knob	Gate attack
5	ratio/range/[range] control knob	Gate range
6	hold control knob	Gate hold
7	IN switch	Gate sidechain in/out
8	freq control knob	Gate sidechain frequency
9	WIDTH pushbutton	Gate sidechain width: 2 Oct, 1 Oct or 0.3 Oct

EQs

The following diagram shows the input channel EQ parameters copied through scenes.

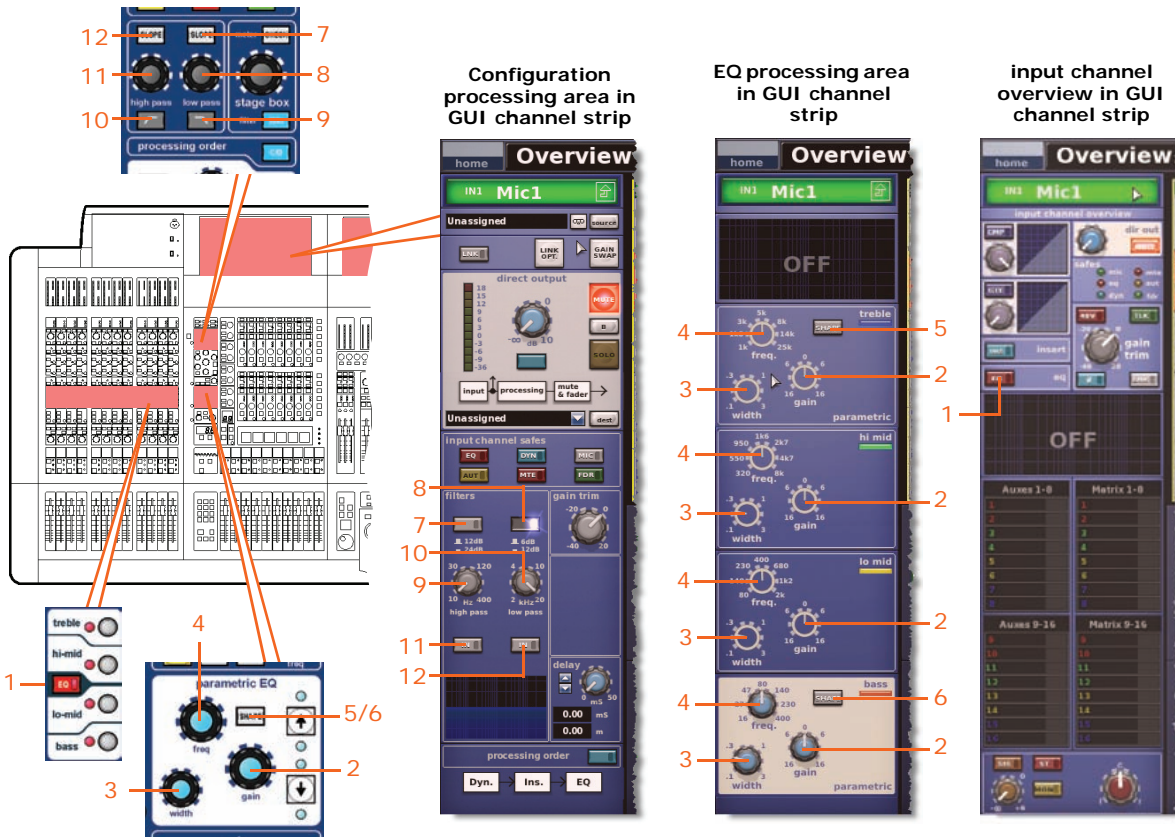

Item	Control	Parameter
1	EQ switch	EQ on/off
2	gain control knob	EQ gain level
3	width control knob	EQ width
4	freq control knob	EQ frequency
5	SHAPE switch	Treble shelving mode: peaking, bright, classic or soft
6	SHAPE switch	Bass shelving mode: peaking, deep, classic or warm
7	SLOPE pushbutton	Low pass filter slope 6dB or 12dB
8	low pass control knob	Low pass filter frequency
9	<input type="checkbox"/> /[IN] switch	Low pass filter in/out
10	<input type="checkbox"/> /[IN] switch	High pass filter in/out
11	high pass control knob	High pass filter frequency
12	SLOPE pushbutton	High pass filter slope 12dB or 24dB

Aux Sends

This section shows the parameters of the 16 aux sends per input channel that are copied through scenes.

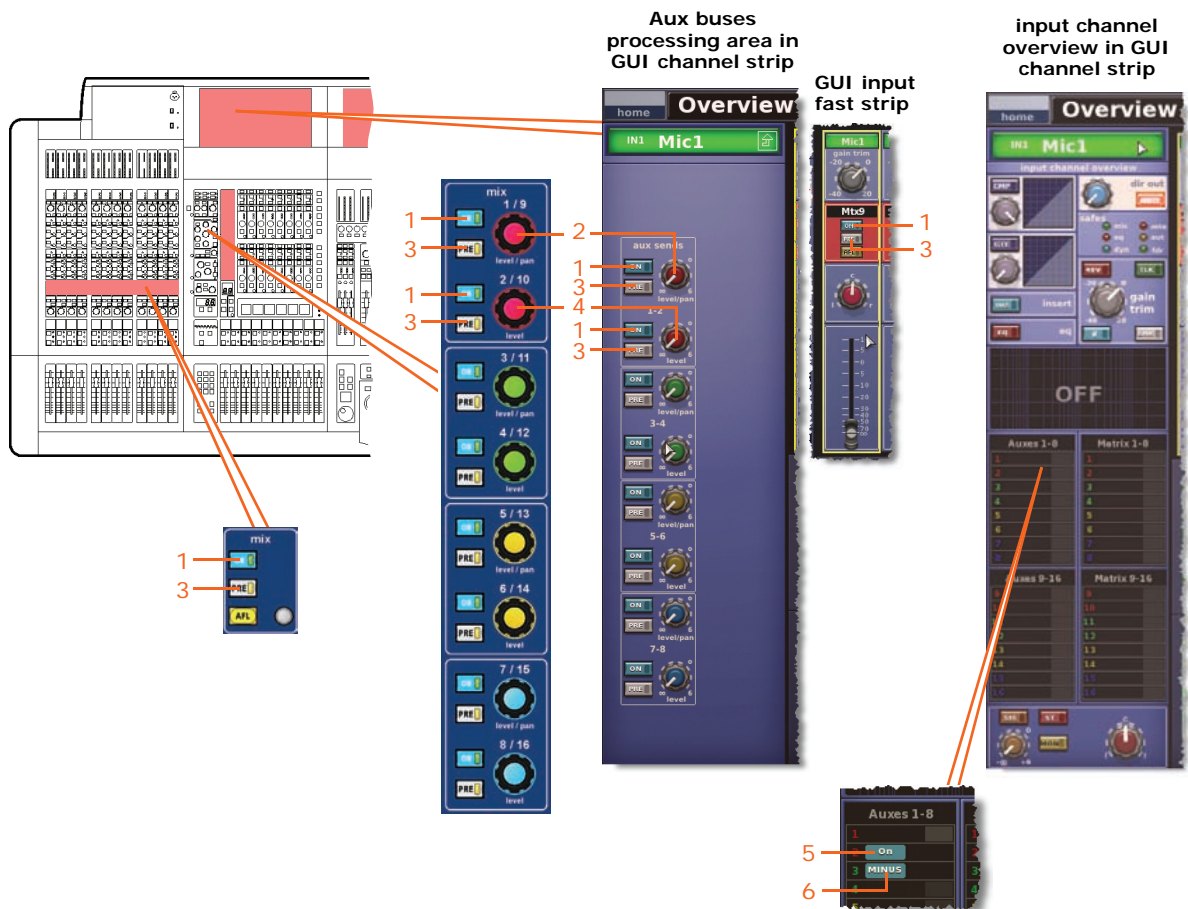

Note: Although only aux sends 1-2 are referenced above, this also applies to all pairs of aux sends.

Item	Control	Parameter
1	ON switch	Bus send on/off
2	level/pan control knob	Bus level, or pan when bus is linked
3	PRE switch	Pre-fader on/off
4	level control knob	Bus level
5	On switch	Aux bus send on/off — only available when aux bus is in group mode
6	MINUS switch	Aux bus send mute on/off — only available when aux bus is in mix minus mode

Matrix Sends

This section shows the parameters of the matrix sends (eight on PRO3 and 16 on PRO6 and PRO9) per input channel that are copied through scenes.

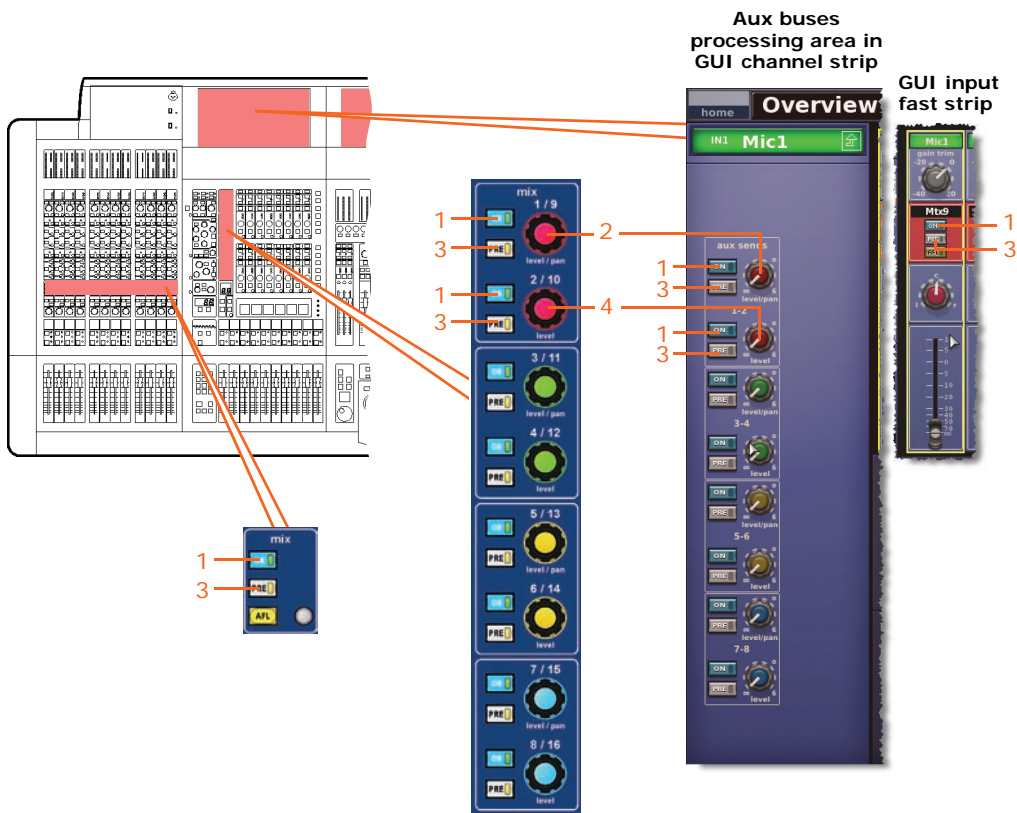

Note: Although only matrix sends 1-2 are referenced above, this also applies to all pairs of matrix sends.

Item	Control	Parameter
1	ON switch	Bus send on/off
2	level/pan control knob	Bus level, or pan when bus is linked
3	PRE switch	Pre-fader on/off
4	level control knob	Bus level

Fader Sections

This section shows all the parameters of the input channel master routing parameters copied through scenes.

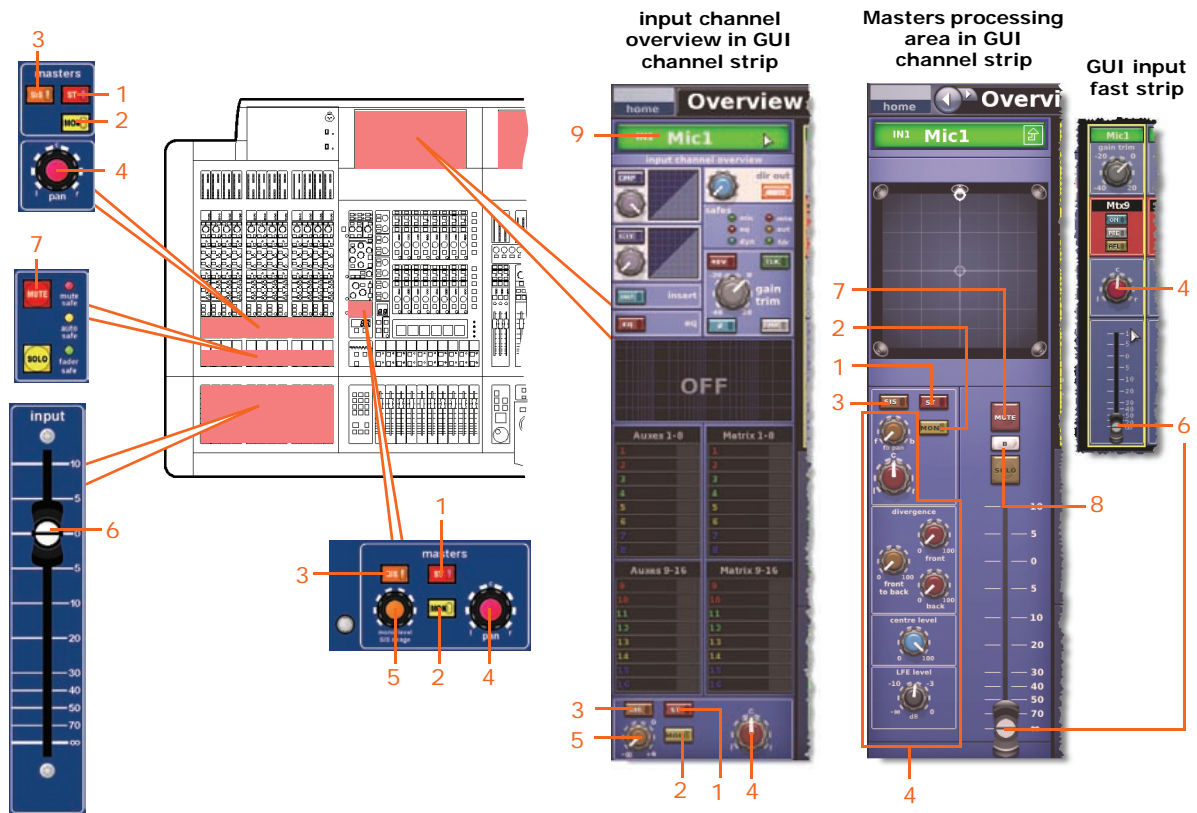

Item	Control	Parameter
1	ST switch	Stereo on/off
2	MON switch	Mono on/off
3	SIS switch	Spatial imaging system on/off
4	Panning control knobs	Surround panning (includes all surround sound parameters)
5	mono level/SIS image control knob	Mono level (SIS off) or SIS image (SIS on)
6	Fader	Level
7	MUTE switch	Mute on/off
8	B control knob	Solo B in/out
9	Field	Channel name

Recall Scope

For details, see "Inputs" on page 423.

Store Scope

For details, see "Inputs" on page 423.

Routing

The following diagram shows the input channel routing parameters copied through scenes.

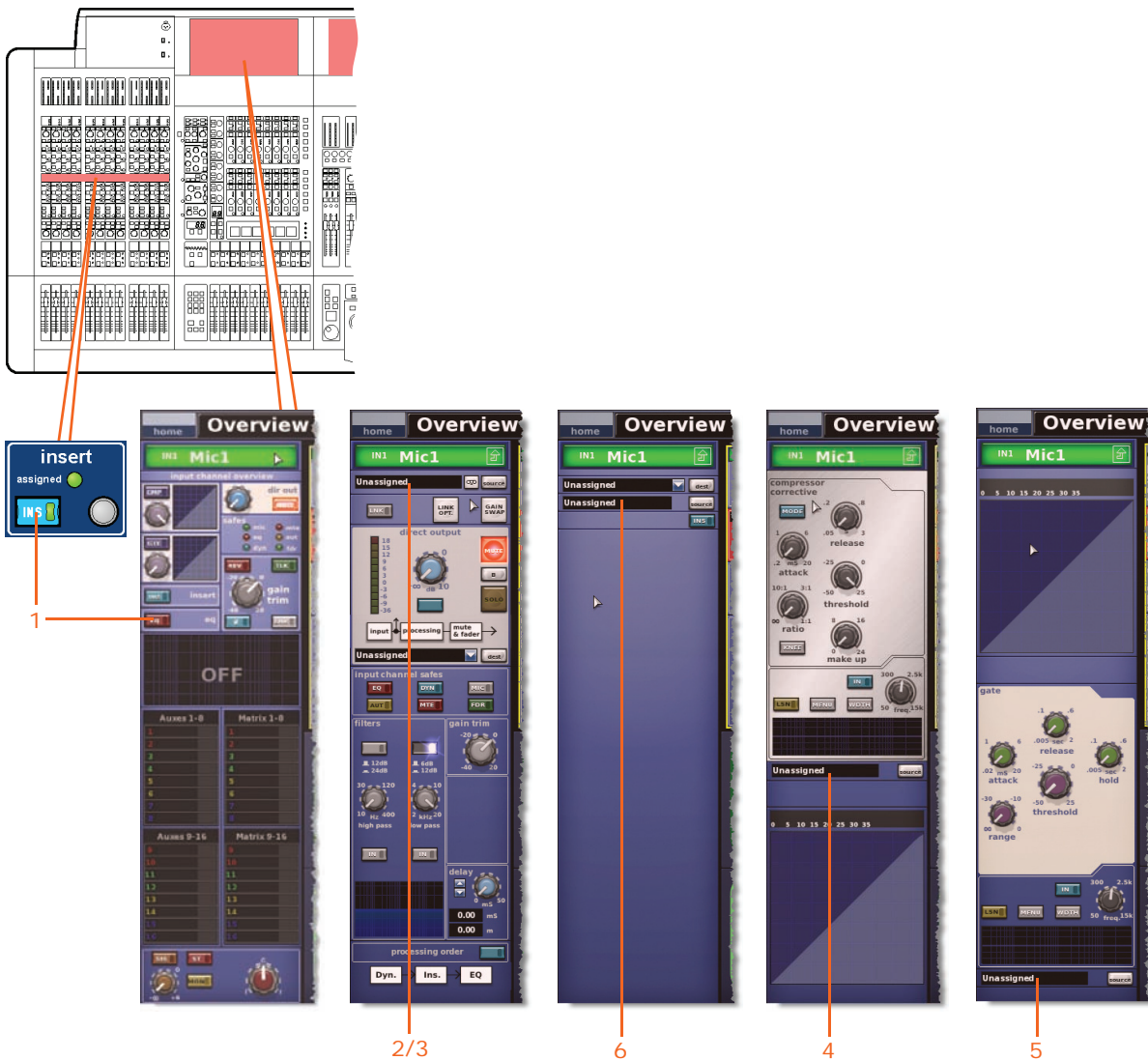

Item	Control	Parameter
1	INS switch	Insert in/out
2	Field	Primary input source
3	Field	Tape input source
4	Field	Compressor sidechain source*
5	Field	Gate key source*
6	Field	Insert return source*

* Only automated when automate patching is on.

Aux Returns (return channels)

This section shows you which parameters for each of the 16 return channels are affected by copy through scenes.

Config sections

The following diagram shows the aux return parameters of the configuration processing area copied through scenes.

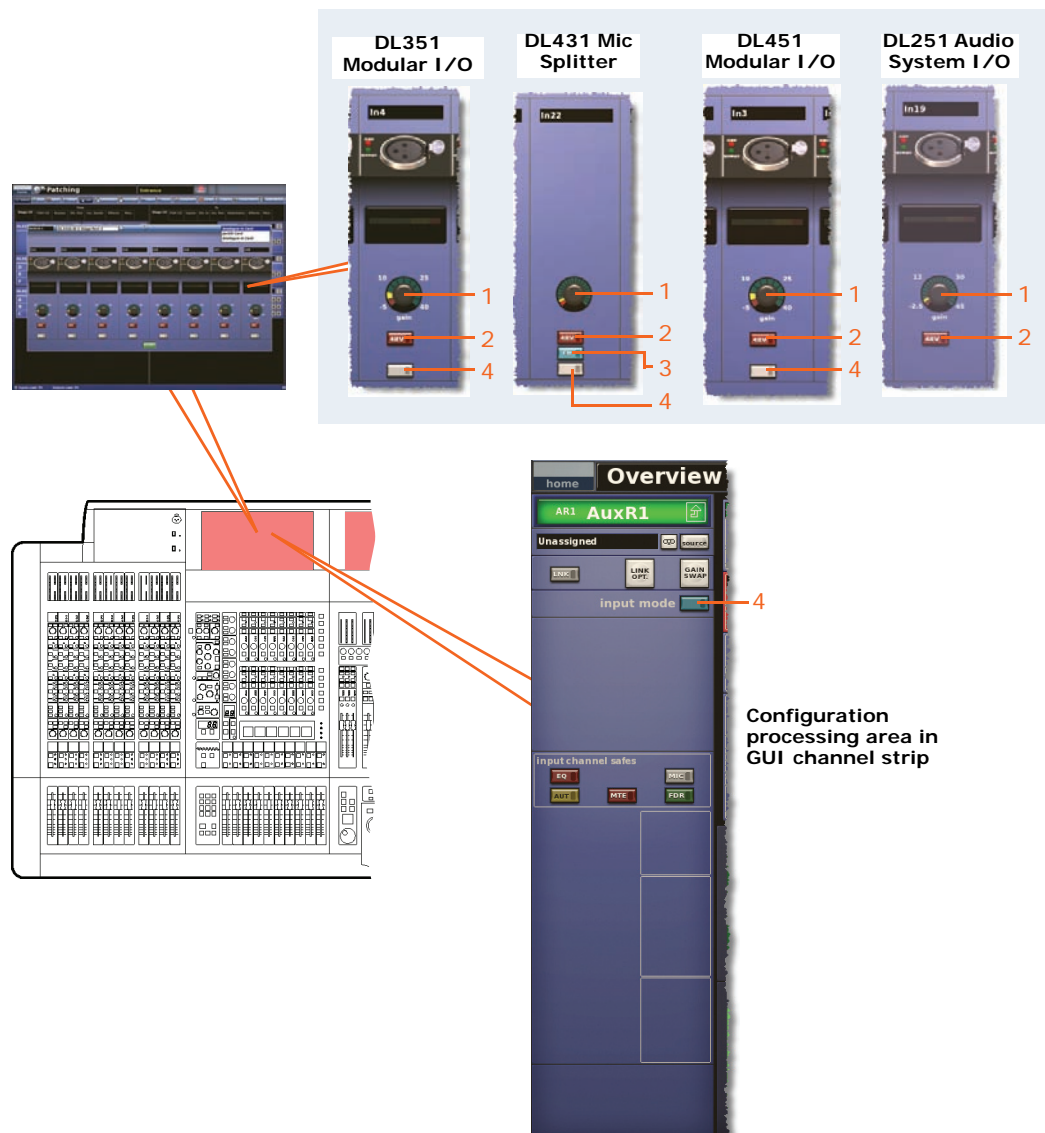

Configuration processing area in GUI channel strip

Item	Control	Parameter
1	Stage box control knob	Remote amplifier level
2	48V switch	48V phantom voltage on/off
3	Flt switch	30Hz filter in/out
4	input mode switch	Input zone in/out

Comp./Output Dyn

Not applicable.

Gates

Not applicable.

EQs

Not applicable.

Aux Sends

Not applicable.

Matrix Sends

The following diagram shows the parameters of the matrix sends (eight on PRO3 and 16 on PRO6 and PRO9) that are copied through scenes.

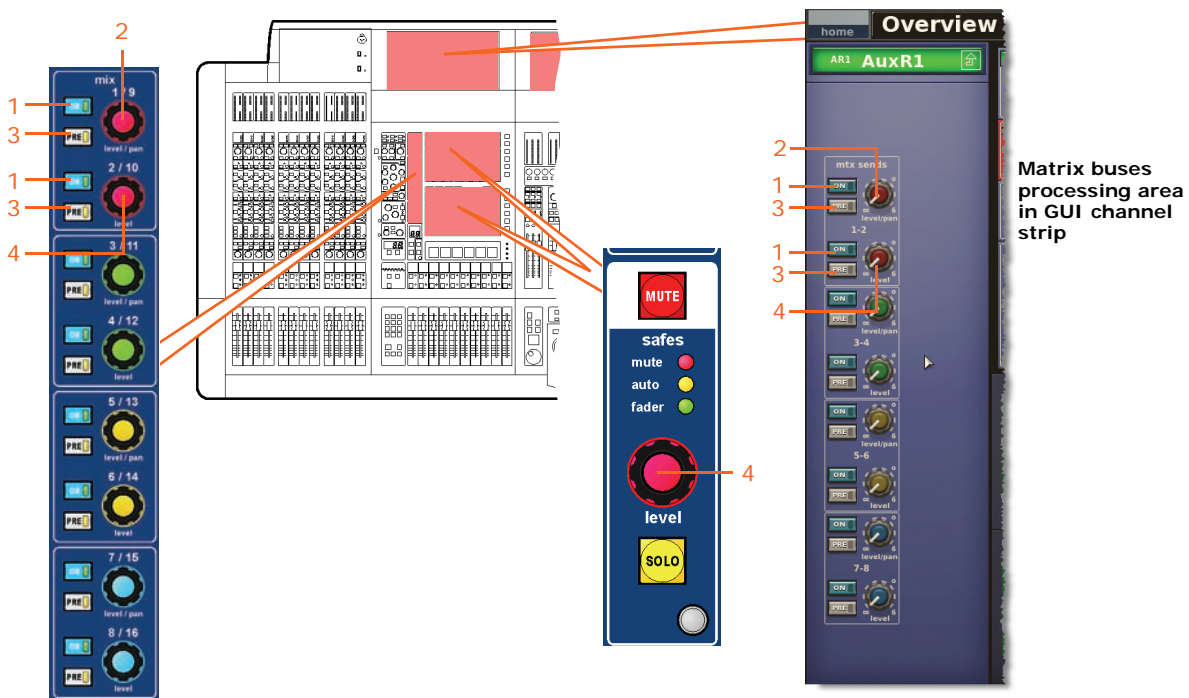

Note: Although only matrix sends 1-2 are referenced above, this also applies to all pairs of matrix sends.

Item	Control	Parameter
1	ON switch	Matrix bus send on/off
2	level/pan control knob	Bus level, or pan when bus is linked
3	PRE switch	Pre-fader on/off
4	level control knob	Bus level

Fader Sections

The following diagram shows the parameters of the master routing processing area copied through scenes.

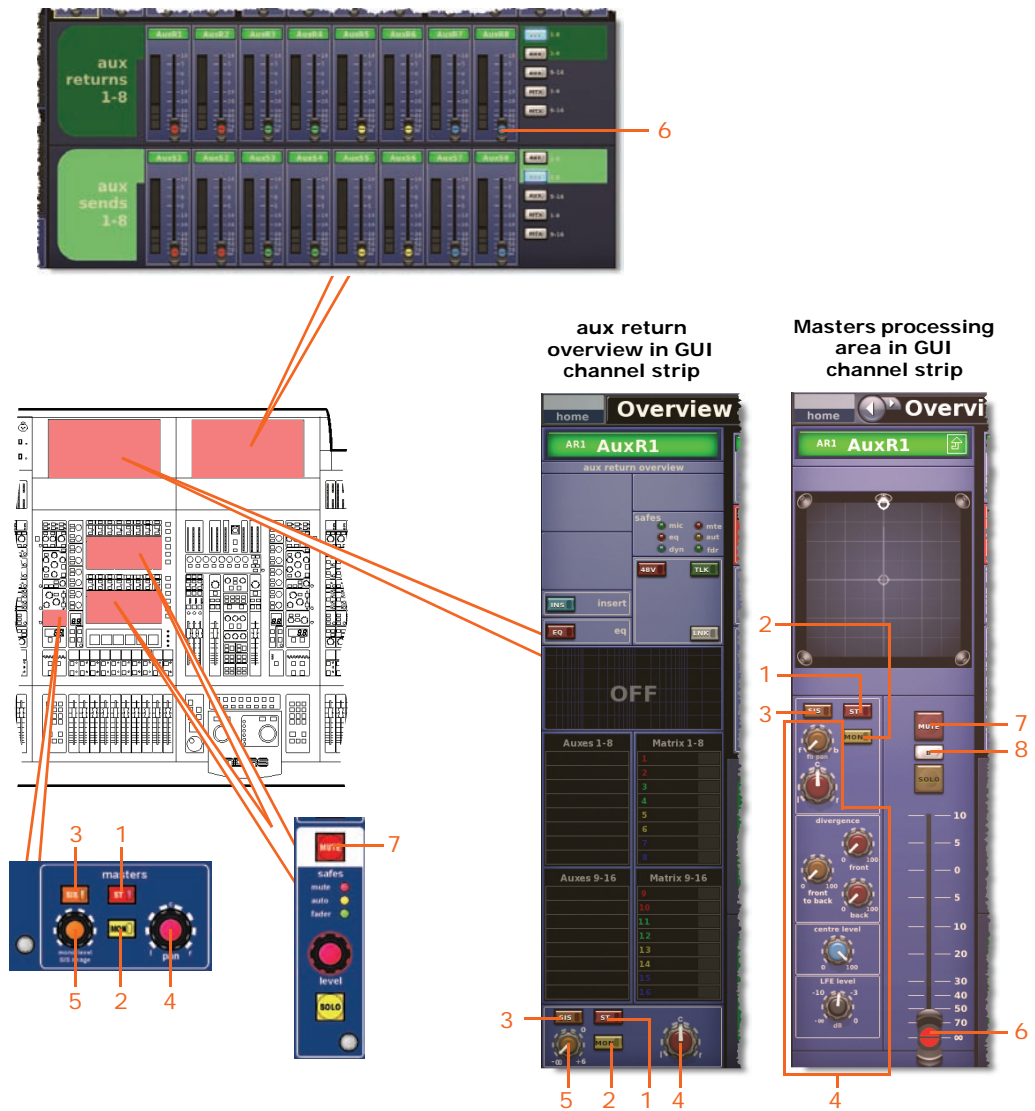

Item	Control	Parameter
1	ST switch	Stereo on/off
2	MON switch	Mono on/off
3	SIS switch	Spatial imaging system on/off
4	Panning control knobs	Surround panning (includes all surround sound parameters)
5	mono level/SIS image control knob	Mono level (SIS off) or SIS image (SIS on)
6	Fader	Level
7	MUTE switch	Mute on/off
8	SOLO B/[B] switch	Solo B in/out

Recall Scope

For details, see “Returns (Aux Returns)” on page 433.

Store Scope

For details, see “Returns (Aux Returns)” on page 433.

Routing

The following diagram shows the return channel routing parameters copied through scenes.

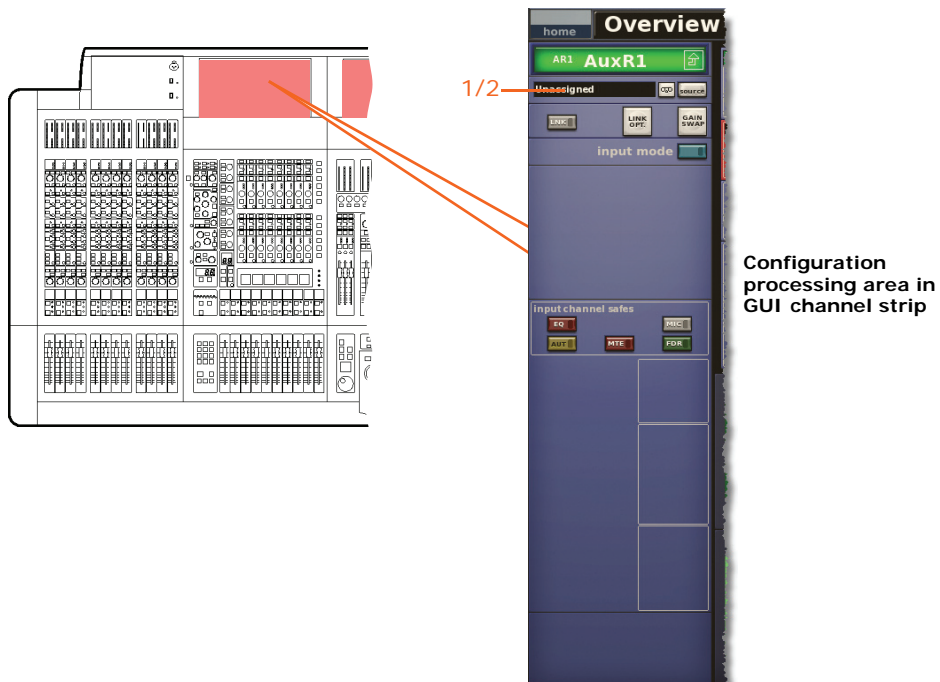

<i>Item</i>	<i>Control</i>	<i>Parameter</i>
1	Field	Primary input source
2	Field	Tape input source

Aux Sends (aux channels)

This section shows you which parameters for each of the 16 aux channels are affected by copy through scenes.

Config sections

The following diagram shows the parameters of the configuration processing area copied through scenes.

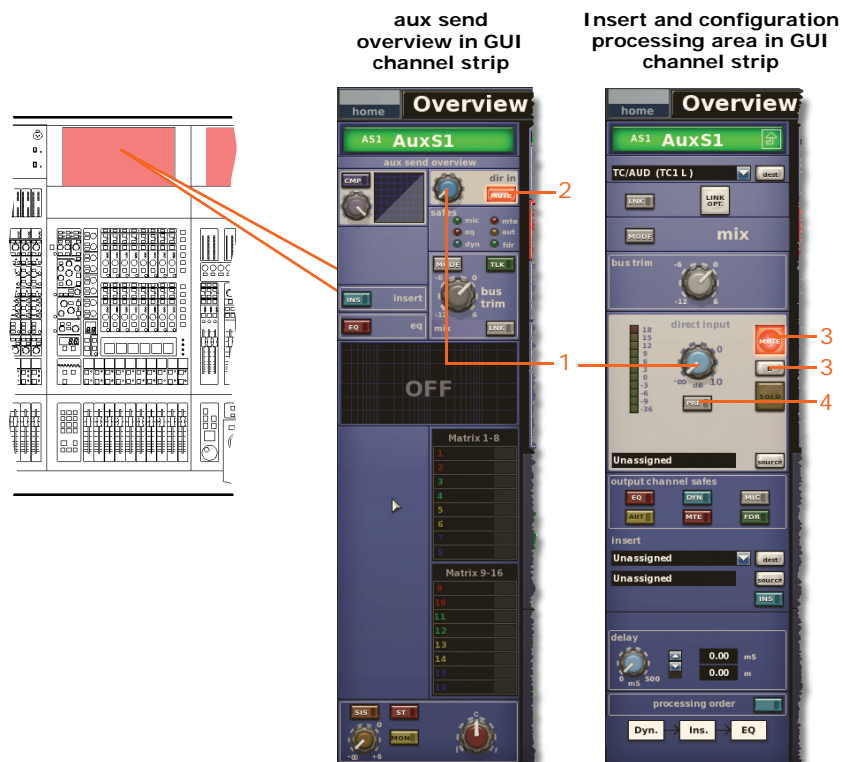

Item	Control	Parameter
1	Control knob	Direct input level
2	MUTE switch	Direct input mute on/off
3	B switch	Direct input solo B in/out
4	PRE switch	Direct input pre- in/out

Comp./Output Dyn

The following diagram shows the parameters of the compressor processing area copied through scenes.

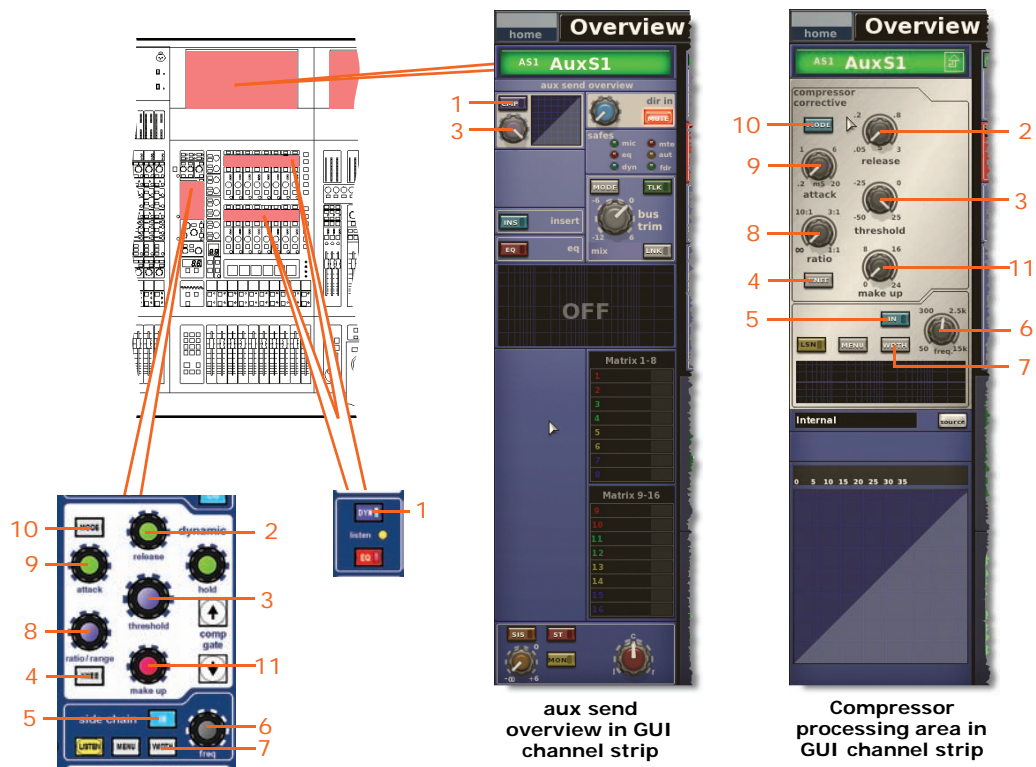

Note: Only the corrective compressor is shown above, but this is typically the same for the other compressor modes (adaptive, creative, vintage and shimmer).

Item	Control	Parameter
1	DYN/[CMP] switch	Compressor on/off
2	release control knob	Compressor release
3	threshold control knob	Compressor threshold
4	KNEE pushbutton	Compressor knee: hard, medium or soft
5	IN switch	Compressor sidechain in/out
6	freq control knob	Compressor sidechain frequency
7	WIDTH pushbutton	Compressor sidechain width: 2 Oct, 1 Oct or 0.3 Oct
8	ratio/range/[ratio] control knob	Compressor ratio
9	attack control knob	Compressor attack
10	MODE pushbutton	Compressor mode: corrective, adaptive, creative, vintage or shimmer
11	make up control knob	Compressor gain

Gates

Not applicable.

EQs

The following diagram shows the EQ parameters copied through scenes.

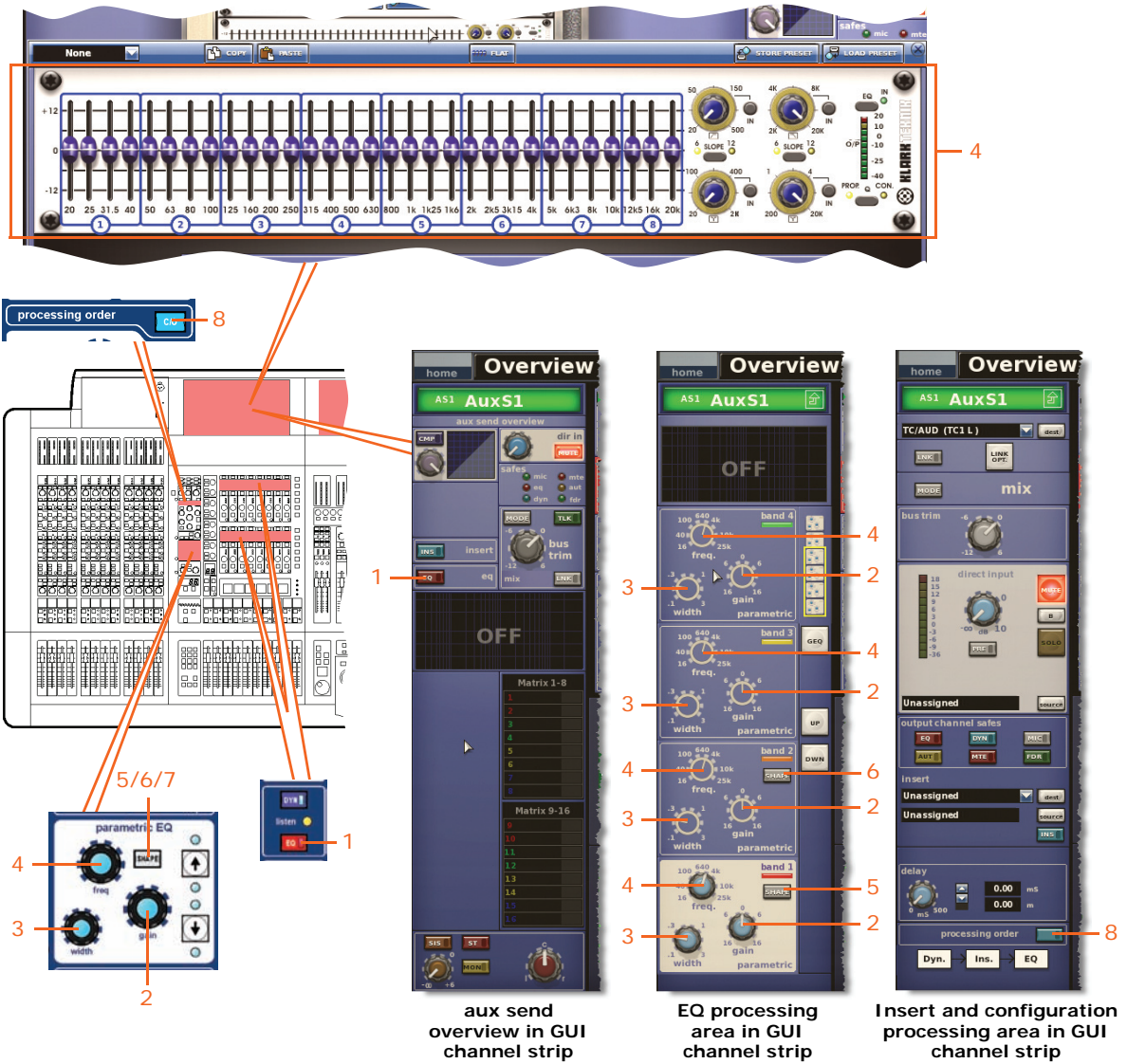

Item	Control	Parameter
1	EQ switch	EQ on/off
2	gain control knob	EQ gain level
3	width control knob	EQ width
4	freq control knob	EQ frequency
5	SHAPE switch	Band 1 shelving mode: bell, warm, high pass 6dB or high pass 12dB
6	SHAPE switch	Band 2 shelving mode: bell or high pass 24dB

Item	Control	Parameter
7*	SHAPE switch	Band 6 shelving mode: bell, soft, low pass 6dB or low pass 12dB
8	C/O switch	Order of processing: Dyn. → Ins. → EQ or EQ → Ins. → Dyn.

* Not shown in diagram.

Note: Although band 6 is not shown above, the items in the table also apply. The band has items 2, 3 and 4, and also includes item 7.

Aux Sends (1 to 16)

Not applicable.

Matrix Sends (1 to 16)

The following diagram shows the parameters of the mix processing area copied through scenes.

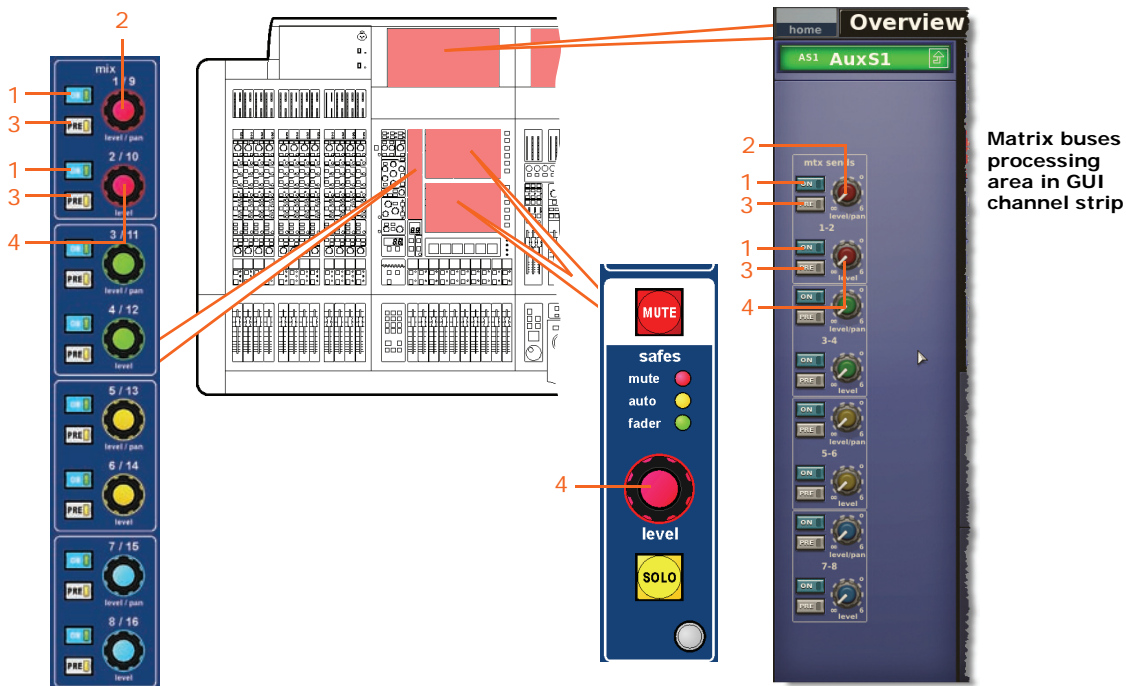

Note: Although only matrix sends 1-2 are referenced above, this also applies to all pairs of matrix sends.

Item	Control	Parameter
1	ON switch	Matrix bus send on/off
2	level/pan control knob	Bus level, or pan when bus is linked
3	PRE switch	Pre-fader on/off
4	level control knob	Bus level

Fader Sections

The following diagram shows the parameters of the master routing processing area copied through scenes.

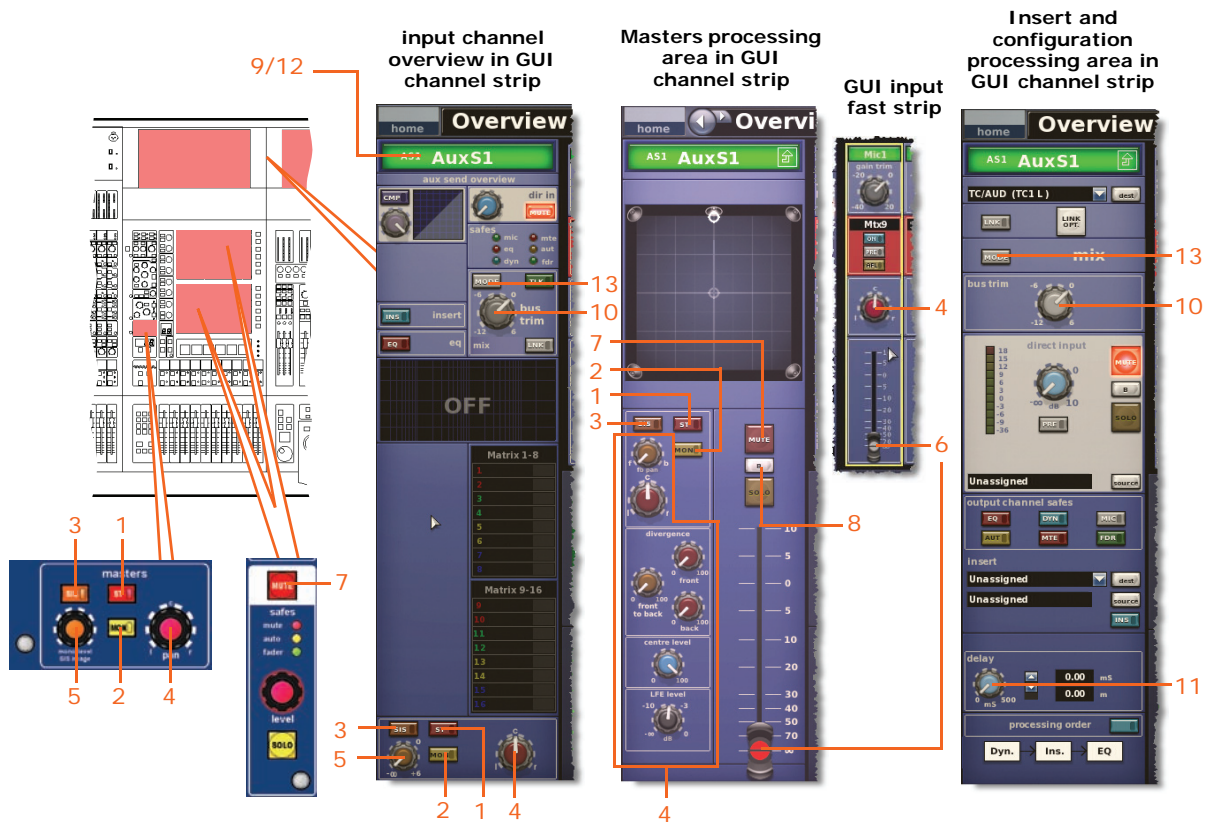

Item	Control	Parameter
1	ST switch	Stereo on/off
2	MON switch	Mono on/off
3	SIS switch	Spatial imaging system on/off
4	Panning control knobs	Surround panning (includes all surround sound parameters)
5	mono level/SIS image control knob	Mono level (SIS off) or SIS image (SIS on)
6	Fader	Level
7	MUTE switch	Mute on/off
8	B switch	Solo B in/out
9	Field	Channel name
10	bus trim control knob	Bus trim level
11	delay control knob	Delay time
12	Field	Channel colour
13	MODE button	Bus mode

Recall Scope

For details, see “Auxes (Aux Sends)” on page 439.

Store Scope

For details, see “Auxes (Aux Sends)” on page 439.

Routing

The following diagram shows the aux channel routing parameters copied through scenes.

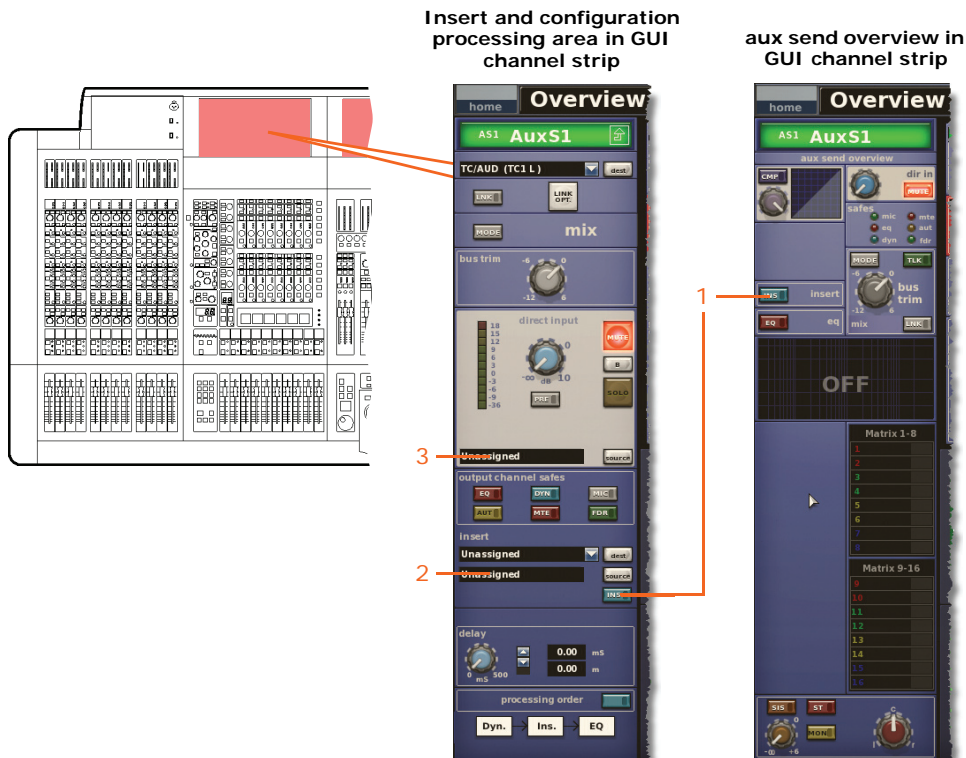

Item	Control	Parameter
1	INS switch	Insert in/out
2	Field	Insert return source*
3	Field	Direct input source*

* Only automated when automate patching is on.

Matrix (matrix channels)

This section shows you which parameters per matrix channel (eight on the PRO3 and 16 on the PRO6 and PRO9) that are affected by copy through scenes.

Config sections

The following diagram shows the parameters of the configuration processing area copied through scenes.

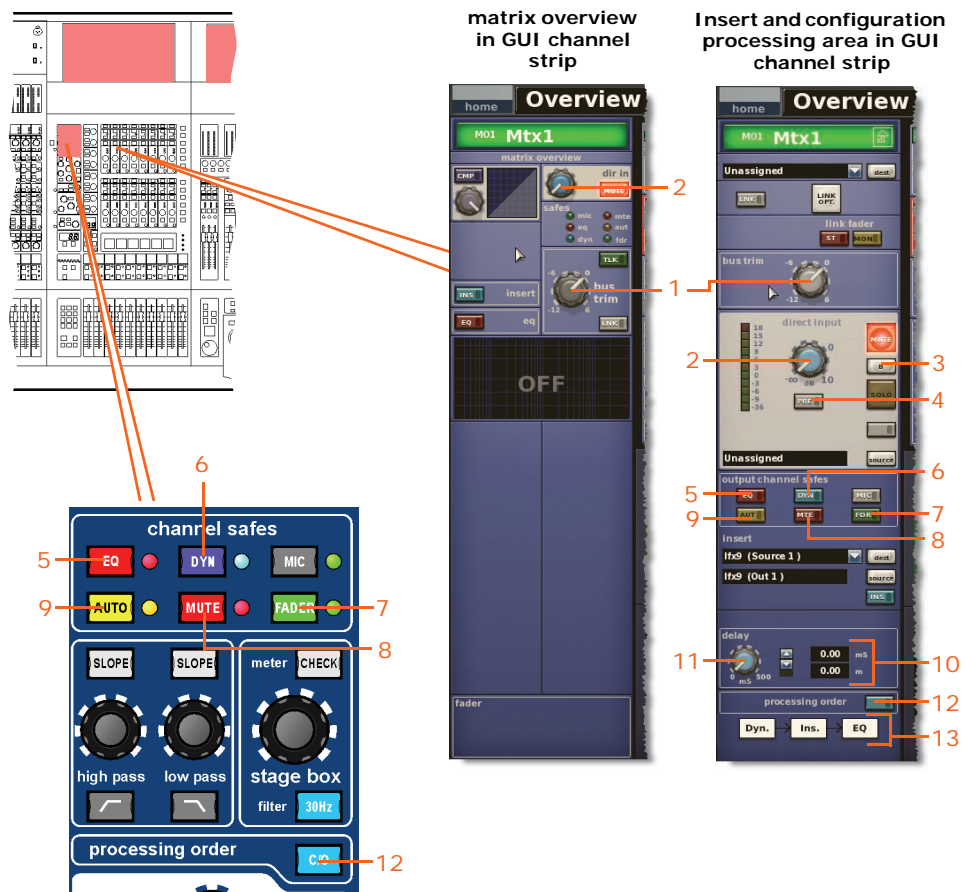

Item	Control	Parameter
1	bus trim control knob	Bus trim level
2	Control knob	Direct input level
3	B switch	Direct input solo B on/off
4	PRE switch	Direct input pre- in/out
5	EQ pushbutton	EQ safe on/off
6	DYN pushbutton	Dynamic safe on/off
7	FADER/[FDR] switch	Fader safe on/off
8	MUTE/[MTE] switch	Mute safe on/off
9	AUTO/[AUT] switch	Auto safe on/off
10	Delay field	Delay in milliseconds (ms) and metres (m)

Item	Control	Parameter
11	delay control knob	Delay level
12	C/O switch	Order of processing: Dyn. → Ins. → EQ or EQ → Ins. → Dyn.
13	Graphic	Order of processing
14	Field	Direct input source

Comp./Output Dyn

The following diagram shows the parameters of the compressor processing area copied through scenes.

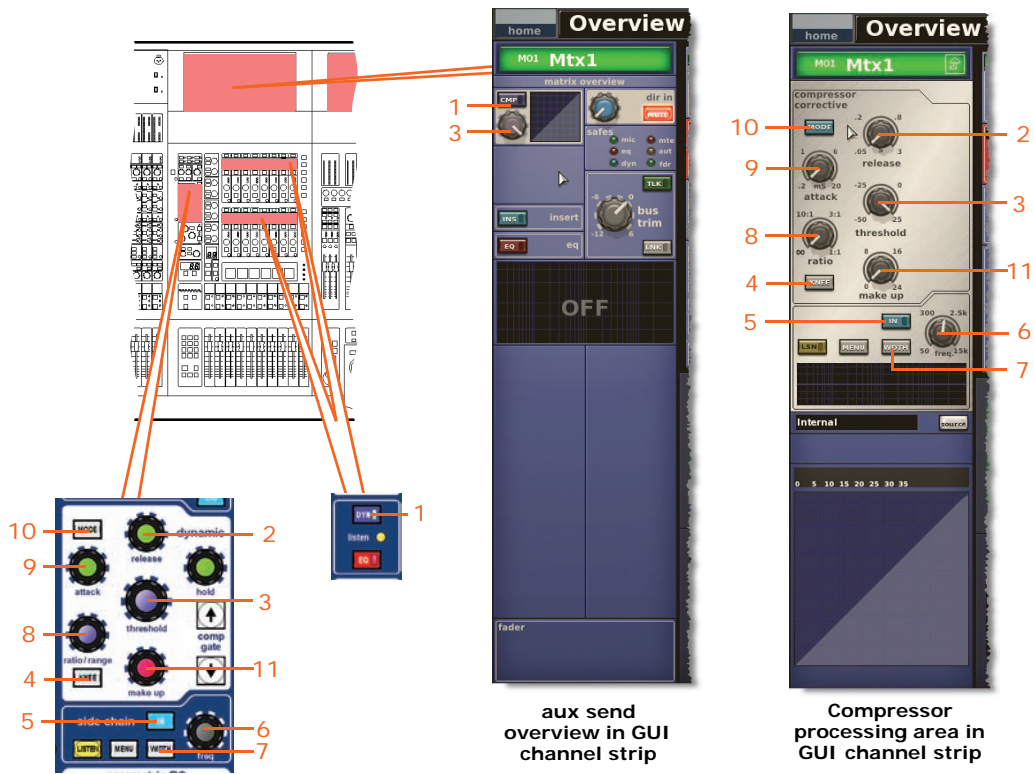

Note: Only the corrective compressor is shown above, but this is typically the same for the other compressor modes (adaptive, creative, vintage and shimmer).

Item	Control	Parameter
1	DYN /[CMP] switch	Compressor on/off
2	release control knob	Compressor release
3	threshold control knob	Compressor threshold
4	KNEE pushbutton	Compressor knee: hard, medium or soft
5	IN switch	Compressor sidechain in/out
6	freq control knob	Compressor sidechain frequency
7	WIDTH pushbutton	Compressor sidechain width: 2 Oct, 1 Oct or 0.3 Oct

Item	Control	Parameter
8	ratio/range /[ratio] control knob	Compressor ratio
9	attack control knob	Compressor attack
10	MODE pushbutton	Compressor mode: corrective, adaptive, creative, vintage or shimmer
11	make up control knob	Compressor gain

Gates

Not applicable.

EQs

The following diagram shows the parameters of the EQ processing area copied through scenes.

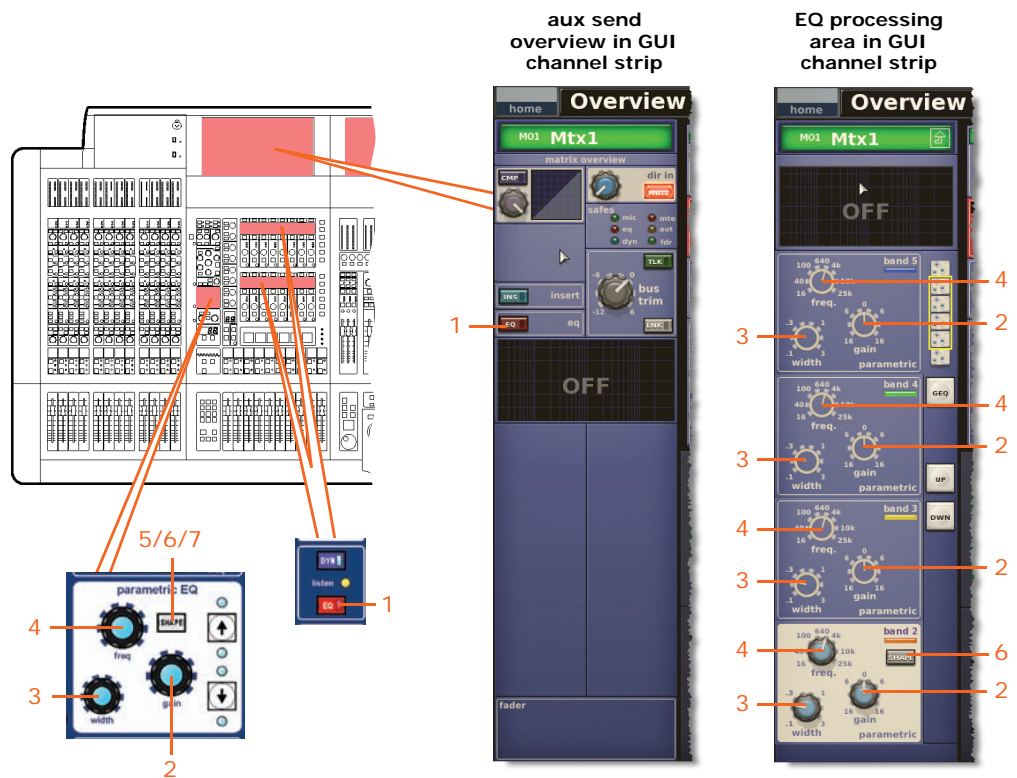

Item	Control	Parameter
1	EQ switch	EQ on/off
2	gain control knob	EQ gain level
3	width control knob	EQ width
4	freq control knob	EQ frequency
5*	SHAPE switch	Band 1 shelving mode: bell, warm, high pass 6dB or high pass 12dB

<i>Item</i>	<i>Control</i>	<i>Parameter</i>
6	SHAPE switch	Band 2 shelving mode: bell or high pass 24dB
7*	SHAPE switch	Band 6 shelving mode: bell, soft, low pass 6dB or low pass 12dB

* Not shown in diagram.

Note: Although bands 1 and 6 are not shown above, the items in the table also apply. Both bands have items 2, 3 and 4, and band 1 also has item 5 and band 6 also has item 7.

Aux Sends

Not applicable.

Matrix Sends

Not applicable.

Fader Sections

The following diagram shows the parameters of the master routing processing area copied through scenes.

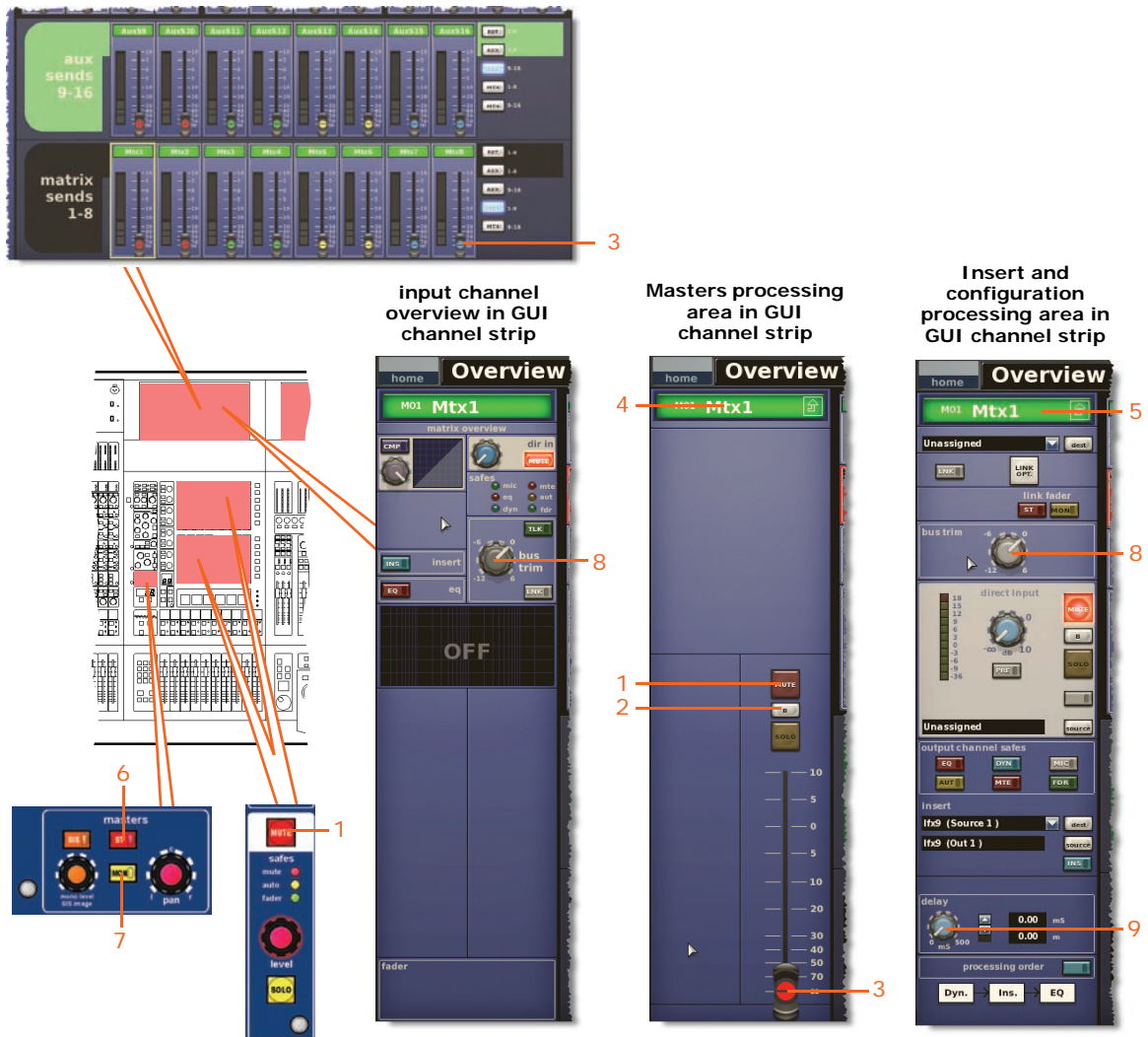

Item	Control	Parameter
1	MUTE switch	Mute on/off
2	B switch	Solo B in/out
3	Fader	Level
4	Field	Channel name
5	Field	Channel colour
6	ST switch	Link to stereo master fader
7	MON switch	Link to mono master fader
8	bus trim control knob	Bus trim level
9	delay control knob	Delay time

Recall Scope

For details, see “Matrices” on page 447.

Store Scope

For details, see “Matrices” on page 447.

Routing

The following diagram shows the matrix channel routing parameters copied through scenes.

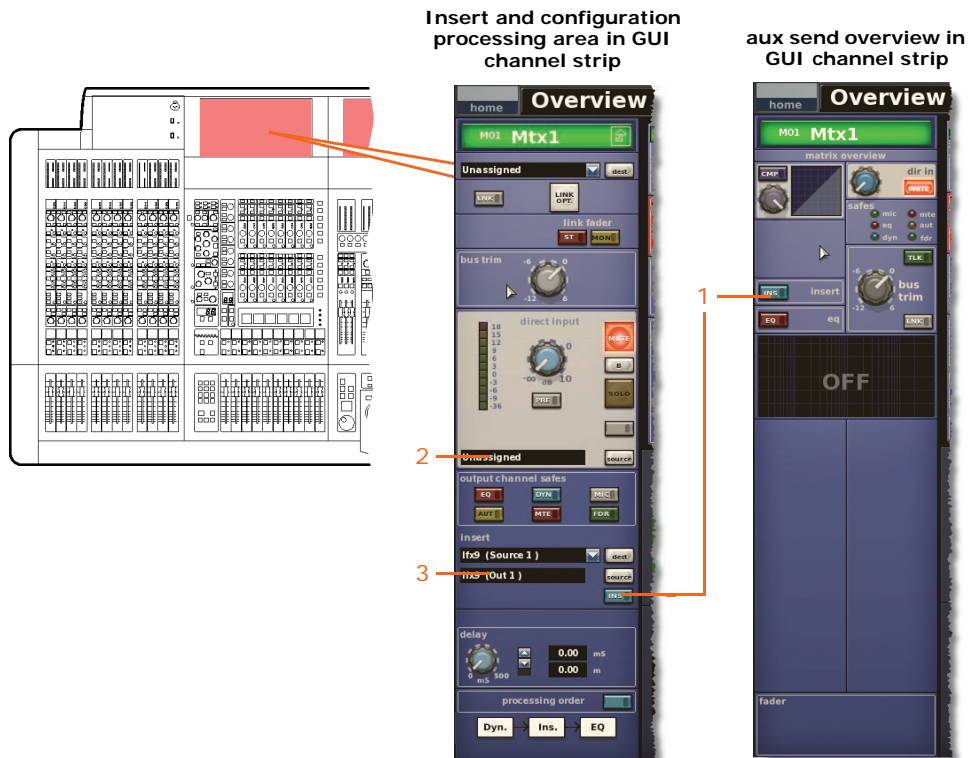

Item	Control	Parameter
1	INS switch	Insert in/out
2	Field	Insert return source*
3	Field	Direct input source*

* Only automated when automate patching is on.

GEQs

You can copy the assignments (circled right) of the 16 internal GEQs through scenes.

Only the **Recall Scope** and **Store Scope** options in the **Sections** area are applicable to this option.

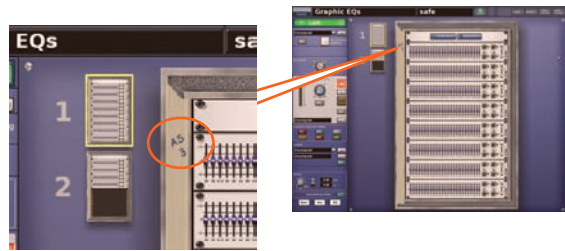

Effects

You can copy the assignments of the internal effects (circled right) through scenes.

Only the **Recall Scope** and **Store Scope** options in the **Sections** area are applicable to this option.



VCA/POP (groups)

You can copy the group membership allocation of the VCA and Groups through scenes.

None of the options in the **Sections** area are applicable to this option.

Masters (master channels)

This section shows you which parameters for each of the three master channels (mono and stereo left and stereo right) are affected by copy through scenes.

Config sections

The following diagram shows the parameters of the configuration processing area copied through scenes.

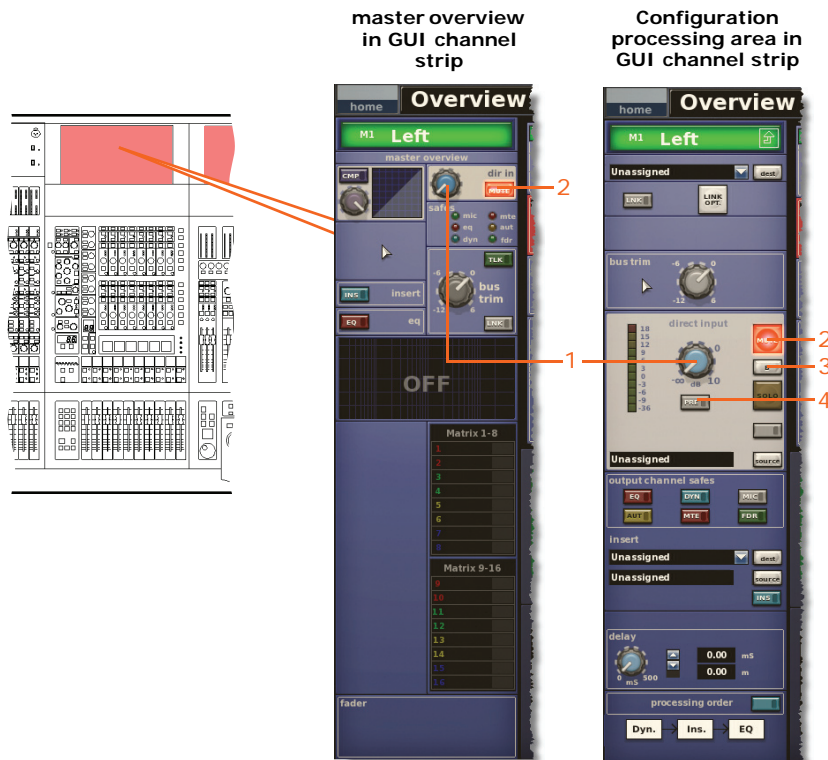

Item	Control	Parameter
1	Control knob	Direct input level
2	MUTE switch	Direct input mute on/off
3	B switch	Direct input solo B on/off
4	PRE switch	Direct input pre- in/out

Comp./Output Dyn

The following diagram shows the parameters of the compressor processing area copied through scenes.

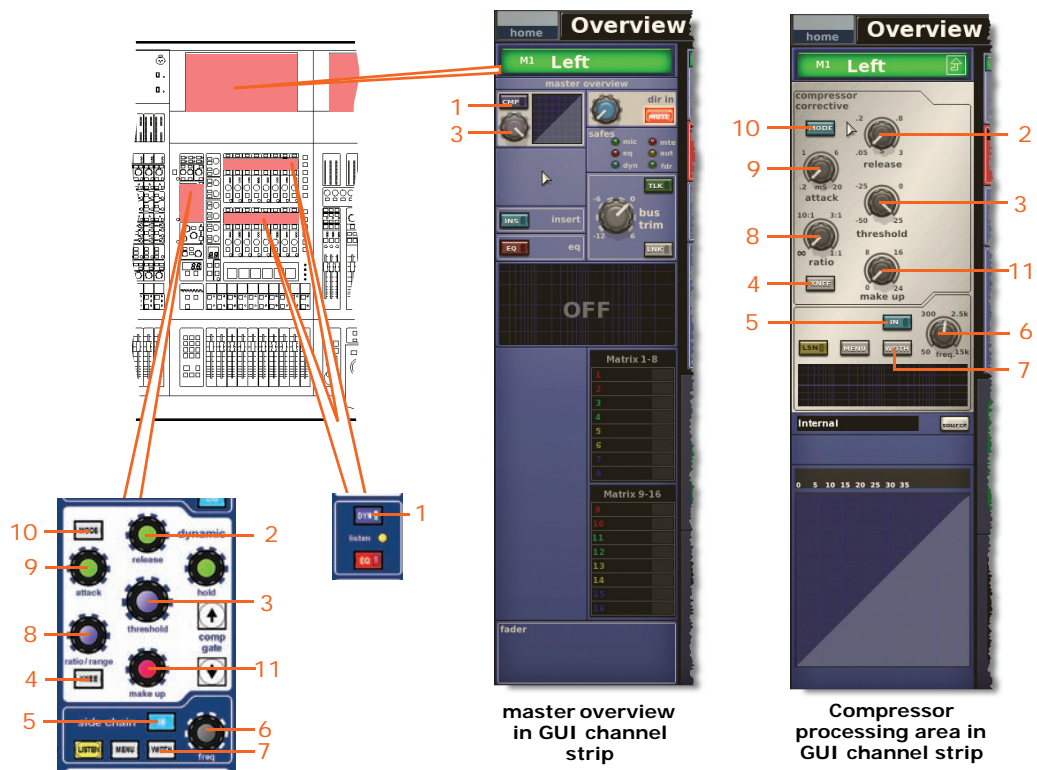

Note: Only the corrective compressor is shown above, but this is typically the same for the other compressor modes (adaptive, creative, vintage and shimmer).

Item	Control	Parameter
1	DYN/[CMP] switch	Compressor on/off
2	release control knob	Compressor release
3	threshold control knob	Compressor threshold
4	KNEE pushbutton	Compressor knee: hard, medium or soft
5	IN switch	Compressor sidechain in/out
6	freq control knob	Compressor sidechain frequency
7	WIDTH pushbutton	Compressor sidechain width: 2 Oct, 1 Oct or 0.3 Oct
8	ratio/range/[ratio] control knob	Compressor ratio
9	attack control knob	Compressor attack
10	MODE pushbutton	Compressor mode: corrective, adaptive, creative, vintage or shimmer
11	make up control knob	Compressor gain

Gates

Not applicable.

EQs

The following diagram shows the parameters of the EQ processing area copied through scenes.

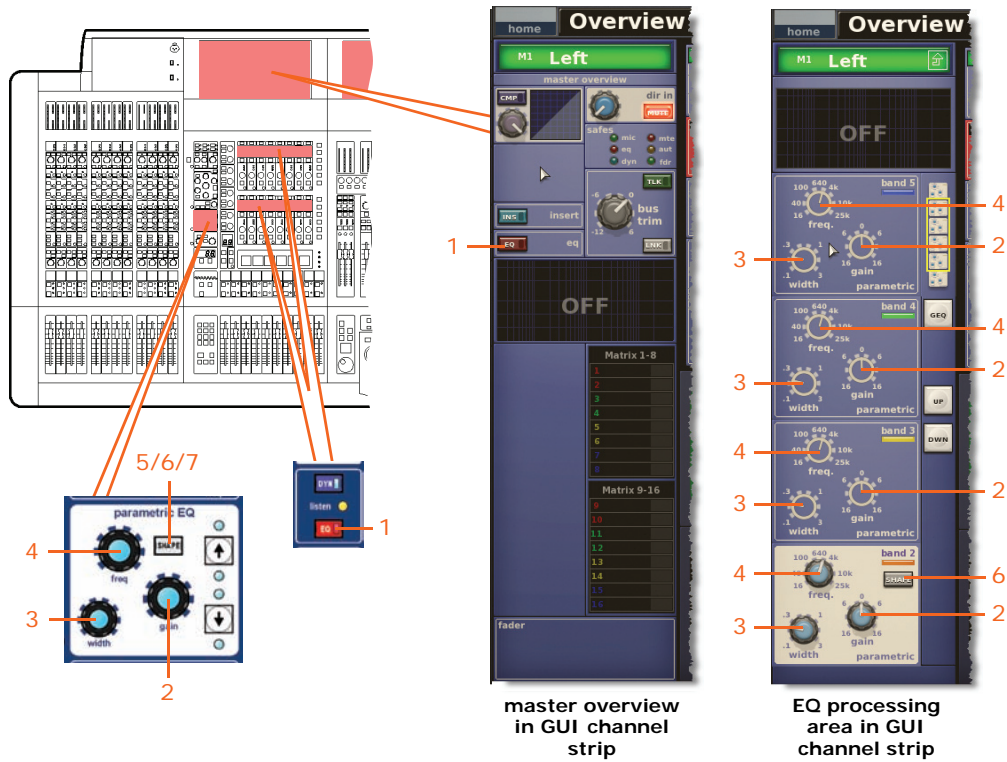

Item	Control	Parameter
1	EQ switch	EQ on/off
2	gain control knob	EQ gain level
3	width control knob	EQ width
4	freq control knob	EQ frequency
5*	SHAPe switch	Band 1 shelving mode: bell, warm, high pass 6dB or high pass 12dB
6	SHAPe switch	Band 2 shelving mode: bell or high pass 24dB
7*	SHAPe switch	Band 6 shelving mode: bell, soft, low pass 6dB or low pass 12dB

* Not shown in diagram.

Note: Although bands 1 and 6 are not shown above, the items in the table also apply. Both bands have items 2, 3 and 4, and band 1 also has item 5 and band 6 also has item 7.

Aux Sends

Not applicable.

Matrix Sends

The following diagram shows the parameters per master channel of the matrix sends (eight on PRO3 and 16 on the PRO6 and PRO9) that are copied through scenes.

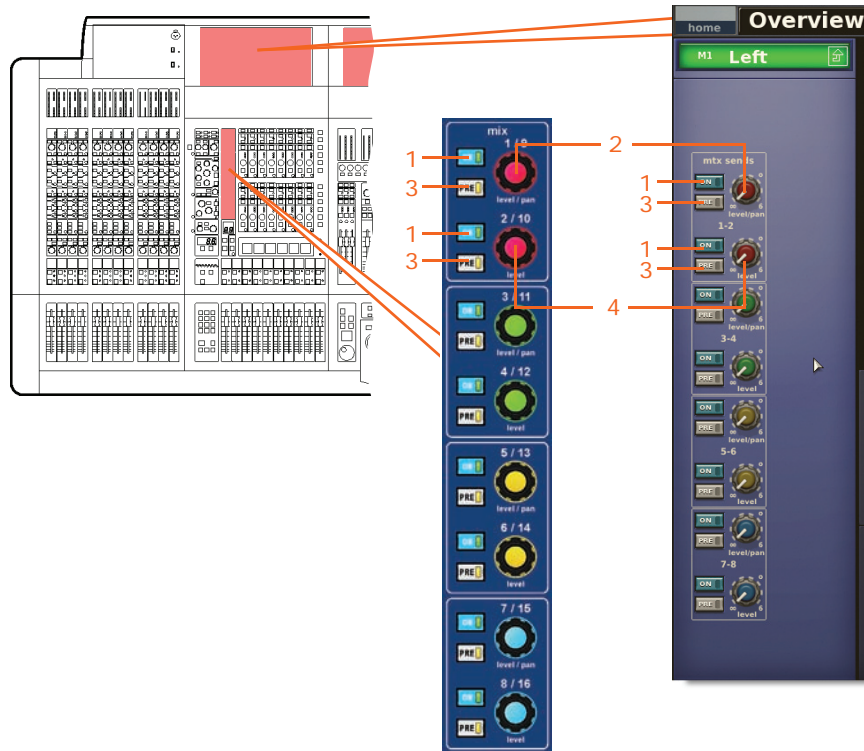

Item	Control	Parameter
1	ON switch	Matrix bus send on/off
2	level/pan control knob	Bus level, or pan when bus is linked
3	PRE switch	Pre-fader on/off
4	level control knob	Bus level

Note: Although only matrix sends 1-2 are referenced above, this also applies to all pairs of matrix sends.

Fader Sections

The following diagram shows the parameters of the master routing processing area copied through scenes.

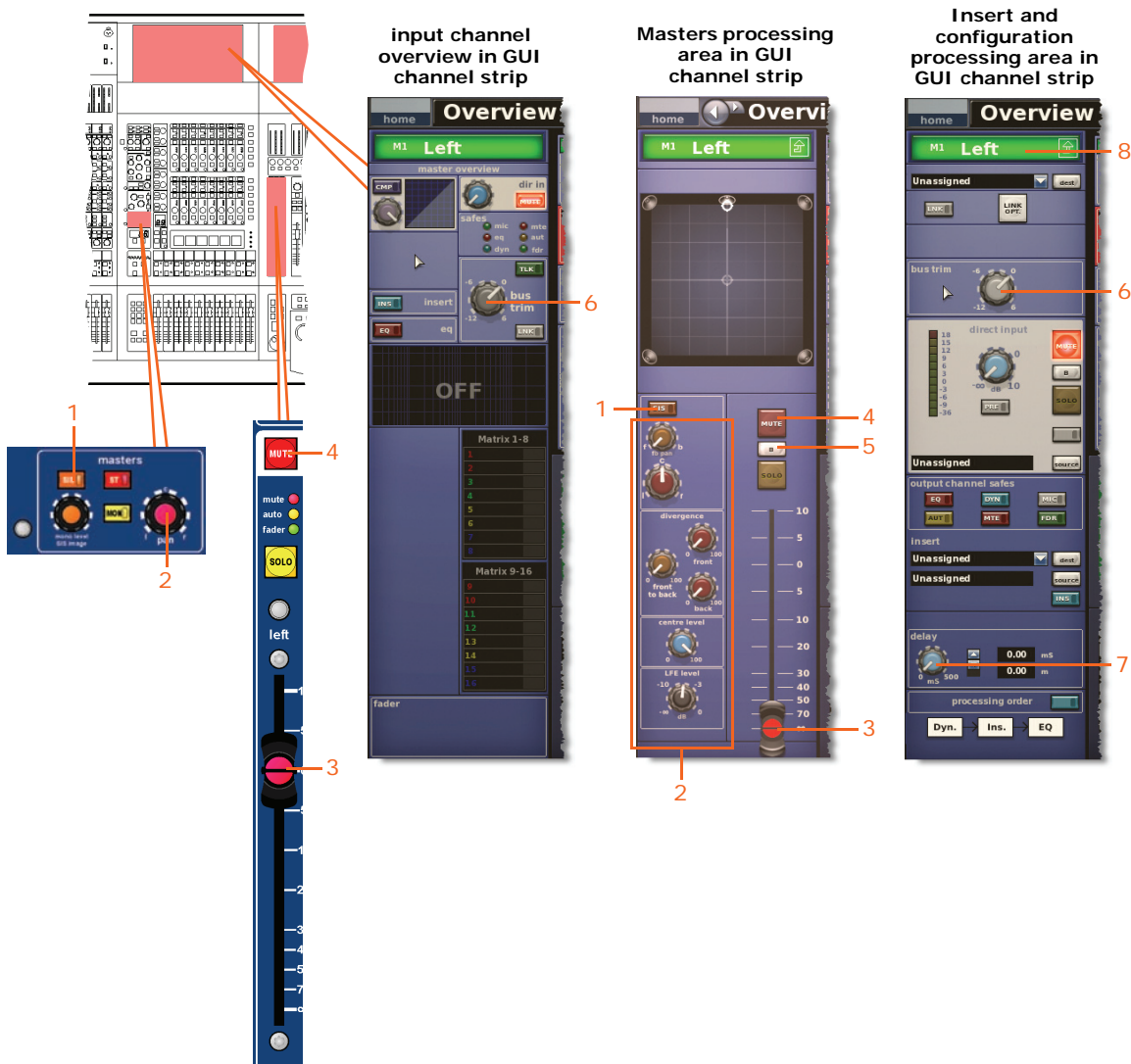

Item	Control	Parameter
1	SIS switch	Spatial imaging system on/off
2	Panning control knobs	Surround panning (includes all surround sound parameters)
3	Fader	Level
4	MUTE switch	Mute on/off
5	B switch	Solo B in/out
6	bus trim control knob	Bus trim level
7	delay control knob	Delay time
8	Field	Channel colour

Recall Scope

For details, see “Masters” on page 453.

Store Scope

For details, see “Masters” on page 453.

Routing

The following diagram shows the master channel routing parameters copied through scenes.

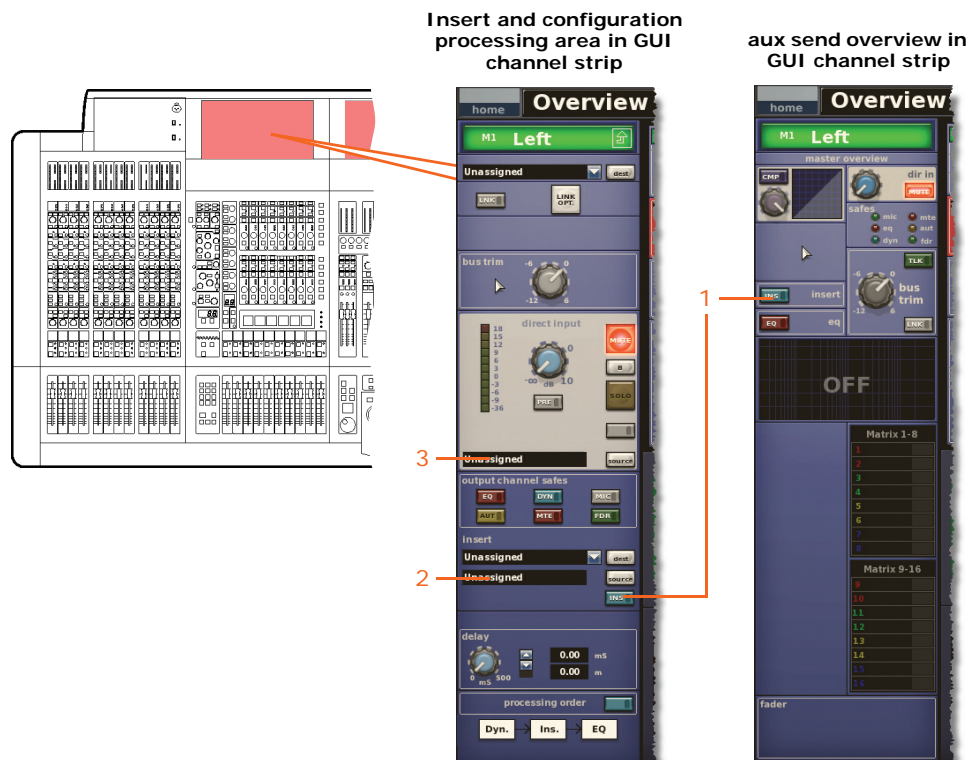

Item	Control	Parameter
1	INS switch	Insert in/out
2	Field	Insert return source*
3	Field	Direct input source*

* Only automated when automate patching is on.

Misc (miscellaneous)

The **Misc** section has an **Assignables** option, which lets you copy the current control assignments of the **Assignable Controls** window through scenes. (The levels are not copied.)

None of the options in the **Sections** area are applicable to this option.



Typical **Assignable Controls** window on the GUI

For more information on assignable controls, see Chapter 19 "Assignable Controls (I Zone)" on page 187.

Appendix Q: Service Information

This appendix contains routine service information for the PRO Series Control Centre.

Routine maintenance

To help keep your PRO Series Control Centre unit in good working order and to make sure it gives you optimum performance, we recommend that you carry out the following about once every month.

- Clean the control centre, as detailed in "Cleaning the control centre" (below).
- Check controls for freedom of operation. As the controls are 'self-cleaning', this operation will help to prevent them from sticking.
- Check the functionality of all controls, that is, control knobs, faders, pushbuttons, LEDs etc.
- Check the functionality of equipment.

Cleaning the control centre

Switch off the control centre and electrically isolate it from the mains before cleaning.

Clean the control centre using a dry, lint-free cloth. Do not use harsh abrasives or solvents. When cleaning the equipment, take great care not to damage faders, pushbuttons etc.

Cleaning a GUI screen

Switch off the control centre and electrically isolate it from the mains before cleaning.

Carefully wipe the surface of the GUI screen with a soft, lint-free cloth or screen wipe specially designed for the purpose. When cleaning the GUI screen, observe the following precautions:

- Avoid putting pressure on the screen.
- Don't use harsh abrasives, for example, paper towels.
- Don't apply liquids directly to the screen.
- Don't use ammonia-based cleaners and solvents, such as acetone.

If you are in doubt or have any queries about cleaning the GUI screens, contact Midas Technical Support.

Equipment disposal

When this equipment has come to the end of its useful life, its disposal may come under the DIRECTIVE 2002/96/EC OF THE EUROPEAN PARLIAMENT AND OF THE COUNCIL OF 27 January 2003 on waste electrical and electronic equipment (WEEE).

Hazardous substances in WEEE contaminate water, soil and air and ultimately put at risk our environment and health. The directive aims to minimize the impacts of WEEE on the environment during their lifetimes and when they become waste.

The WEEE directive addresses the disposal of products when they have reached the end of their life and contributes to the reduction of wasteful consumption of natural resources. This will help to reduce pollution, and protect the environment and ourselves.



If this equipment carries a 'crossed-out wheelee bin' (shown left), please do not dispose of WEEE as unsorted municipal waste but collect and dispose of in accordance with local WEEE legislation. The horizontal bar underneath indicates that the product was placed on the EU market after 13th August 2005.

For WEEE disposal; see our website at www.midasconsoles.com for information.

Glossary

This glossary provides an explanation of the symbols, terms and abbreviations used in this manual.

5.1 surround: A surround sound system created from six channels that form a discrete signal, which is played back over a speaker system comprising five speakers (three front and two rear) and a subwoofer (which is the “.1” or LFE channel). See *LFE*.

μ: Micro- prefix symbol that represents 10^{-6} or one millionth.

A

A/D: Abbreviation for “analogue to digital”. The conversion of a continuous signal into a numeric discrete sample sequence.

AC: Abbreviation for “alternating current”.

AES/EBU: Abbreviation for “Audio Engineering Society/European Broadcasting Union”. See *AES3*.

Acoustic feedback: A sound loop existing between an audio input and audio output that is amplified on each cycle. For example, a mic input signal is amplified and passed to a loudspeaker. The output from the loudspeaker is picked up the mic, which amplifies it again and passes it back to the loudspeaker, and so on.

AES3: Also known as “AES/EBU”, this is a serial interface for transferring digital audio between devices.

AES50: AES digital audio engineering standard. AES50 is a high resolution, multi-channel audio interconnection (HRMAI). Rather than a network, it is a high-performance, point-to-point audio interconnection, although the auxiliary data may operate as a true network, independently of the audio. HRMAI provides a professional multi-channel audio interconnection that uses Cat 5e data cable and is compatible with Ethernet networks.

AFL: Abbreviation for “after fader listen”. A function that allows the signal to be monitored post-fader, that is, after it has been acted upon by the fader.

Algorithm: In computing, a set of instructions for accomplishing a specific task.

amp (A): Abbreviation for “ampere”. A unit of current.

Anti-aliasing: When referring to digital images, a technique that avoids poor pixelation.

Area A: Primary input control area.

Area B: A secondary input control area.

Assignable controls: User-assignable controls that can be set up to operate other functions.

Auto safe: Prevents channel from accepting scene recall.

Auto-mute: A function that automatically mutes the channel’s signal under certain conditions.

Auto-mute group: A function that automatically mutes a number of selected channels under certain conditions.

Automation: 1. Memorization and playback of changes made to mixer settings. 2. An area on the master bay that controls these.

Aux: Abbreviation for “auxiliary send” or “aux send”. A designation for extra buses, typically used for sending signal to effects, headphone amps and other destinations. See *Bus*.

Aux send: See *Aux*.

B

Balanced audio: A type of audio connection that uses the three leads in a cable, connector and jack as part of a phase-cancelling arrangement to boost the signal and reduce noise.

Band: In EQ, a range of frequencies.

Bandwidth: In EQ, the width of a band, that is, the number of frequencies that will be boosted/cut above and below a centre frequency.

Bank: A fixed number of channels displayed on a GUI screen.

Bass: Lower frequencies in a signal.

Bay: One of the main control surface sections.

Bus: A pathway down which one or more signals can travel.

C

Cat 5e: A specification for a type of cable used typically for Ethernet computer networks.

Channel: Single path taken by an audio signal (input or output) through the control centre.

Channel strip: Row of controls in traditional analogue layout used for the shaping of a signal.

Checkpoint: A patching data store point, created by clicking **CHECKPOINT**. See *Patching*.

Click: A method of GUI operation, mainly for button operation and selection purposes.

CMR: Abbreviation for “common mode rejection”. A measure of how well a differential amplifier rejects a signal that appears simultaneously and in-phase at both input terminals. CMR is usually stated as a dB ratio at a given frequency.

Comb filtering: Removal of signal components at a number of regularly spaced frequencies.

Compressor: A dynamics processor that reduces the level of any signal exceeding a specified threshold volume.

Condenser microphone: A high quality mic that uses a capacitor to detect changes in the ambient air pressure, which it then converts into an electrical signal. This type of mic requires power from a battery or external source.

Control centre: The PRO Series’ console, comprising control surface and GUI.

Control surface: Area on the control centre that houses all of the user’s hardware controls, such as pushbuttons, control knobs, switches etc.

Crossfade: To combine signals such that one channel or source fades out while another fades in, but maintaining an essentially constant programme volume.

Cursor: Generally, used to describe the “I”-shaped pointer on the GUI that indicates a text insertion point. See *Pointer*.

D

D zone: Section in the input channel strip for controlling dynamic parameters.

D/A: Abbreviation for “digital to analogue”. The conversion of digital data to analogue audio.

DARS: Abbreviation for “digital audio reference signal”.

Dashboard: A standard GUI screen display - usually on the master bay - that shows all channel meters (inputs, auxes, returns, masters etc.) all of the time.

dB: Symbol for “decibel”. A unit of measurement of the loudness of sound. See *dBu*.

dBu: A unit of measurement of sound used in professional audio. Derived from the decibel, where the “u” stands for unloaded, this unit is an RMS measurement of voltage based on $0.775V_{RMS}$, which is the voltage at which you get 1mV of power in a 600 ohm resistor. This used to be the standard impedance in most professional audio circuits.

DC: Abbreviation for “direct current”.

Delay: An effect by which a reproduction of a signal is played back later than its original.

Destination: The patch connector to which a signal is routed. See *Patching*.

Device: A diagram(s) in the I/O tabs representing a physical rack unit, such as a line I/O, mic splitter, DN9696, AES50 etc. See *Patching*.

DI: Abbreviation for “direct inject” or “direct injection”. Signal is plugged directly into the audio chain without using a microphone.

DI box: Device for matching signal level impedance of a source to mixer input.

Drag: A method of GUI operation, mainly for control adjustment. Also used for selecting blocks of patch connectors during patching.

DSP: Abbreviation for “digital signal processing” or “digital signal processor”. Any signal processing done after an analogue audio signal has been converted into digital audio. Can be used to create, for example, compression, equalization etc., of a digital signal. A digital signal processor is a piece of equipment specifically designed for carrying out signal processing.

E

E zone: Section in the input channel strip for controlling EQ parameters.

Effect: One of a number of audio processes that can be applied to a signal to modify it, such as reverb, flanging, phasing, delay etc.

Effects rack: A virtual rack of internal processors. See *Virtual rack*.

Envelope: 1. How a sound or audio signal varies in intensity over time. 2. The visual representation of such, usually shown on a graph in a GUI channel strip.

EQ: Abbreviation for “equaliser” or “equalisation”.

Equalisation: Adjusting the frequency response so that the levels of all frequencies are equal or the same. Bass and treble controls are equalization controls.

EtherCon®: A cable connector for data transfer interconnections, which is more robust than the basic RJ45.

F

Fader: Slider-type device for precise adjustment of signal level or volume of a channel.

Fast strip: One of the strips in the input, mix and output fast zones. See *Input fast strip*, *Mix fast strip*, *Output fast strip* and *Fast zone*.

Fast zone: An area on a bay that contains quick controls. See *Input fast zone*, *Mix fast zone*, *Output fast zone* and *Fast strip*.

FB: Abbreviation for “front-back”. A term used in surround panning.

Feedback: See *Acoustic feedback*.

Filter: A device for removing frequencies above or below certain levels.

FOH: Abbreviation for “front of house”. The area in a theatre used by the public. Used to describe a control centre being used to control the sound that the audience will hear (and not the performers’ monitor system).

Frequency: The number of times that a sound wave’s cycle repeats within one second.

Fricative: A consonant, such as “f” or “s”, produced by the forcing of breath through a constricted passage.

From section: The leftmost area of the patching screen that contains the source patch connectors. See *Patching*.

G

Gain: Another term for signal level.

Gain reduction (compressor): Decrease in gain when input signal is above threshold. See *Gain*.

GEQ: Abbreviation for “graphic equaliser”. See *Graphic EQ*.

GEQ rack: A virtual rack of GEQs. See *Virtual rack*.

Granularity: A measure of the size of components or a description of the components comprising a system.

Graphic EQ: A form of EQ that has a number of faders for controlling the gain of the audio signal. The faders are set at frequency bands that are evenly-spaced according to octaves.

GUI: Abbreviation for “graphical user interface”.

GUI channel strip: Right section of a GUI screen that represents the processing area of the input or output channel strip selected to the control surface.

GUI menu: A menu selectable at either GUI screen by clicking the **home** button (upper-left corner).

GUI screen: One of the two PRO Series’ screens, which comprise the GUI.

H

HPF: Abbreviation for “high pass filter”. A filter that removes lower frequencies from a signal, leaving the higher frequencies unaffected.

Hum: Undesirable low frequency tone present in a signal due to grounding problems or proximity to a power source.

Hz: Symbol for “Hertz”. A unit of frequency equal to one cycle of a sound wave per second.

I

I zone: Area on the master bay that contains the operator-assignable effects controls.

I/O: Abbreviation for “input/output”.

ID: Abbreviation for “identification”.

Ident: Scale marking, or gradation, around a control knob to help indicate the current setting and to assist in accurate adjustment.

Impedance (Z): Opposition to the flow of alternating current in a circuit, measured in ohms.

K

Kernel: For computers, the kernel is the central component of most operating systems.

L

LCD select button: LCD button in the input fast strips and VCA groups, used for channel/group navigation and selection, and operator feedback.

LFE: Abbreviation for “low frequency effects”. Typically, the “.1” in “5.1 surround” is an LFE channel.

Linux: Also known as “Linux kernel”. Operating system kernel used by a family of Unix-like operating systems. See *kernel*.

LS: Abbreviation for “left surround”. The left rear speaker in a 5.1 surround system.

M

MADI: Abbreviation for “multi-channel audio digital interface”.

Master bay: Control area for masters, automation, comms, monitoring etc. Also contains the primary navigation zone.

Masters: The three master channels (mono and stereo left and right) in the master bay.

MB: Abbreviation for “megabyte”.

MC: Abbreviation for “master controller”.

Meter: Visual device to indicate the level of a signal.

Meters screen: One of the GUI screens. This is the default screen of the master bay.

Mic: Abbreviation for “microphone”.

Microphone: Device for converting sound waves into audio signals.

MIDI: Acronym for “musical instrument digital interface”. A digital signal system standard that facilitates integration of musical instruments, such as synthesizers and guitars, with computers.

Mix: 1. A signal that contains a combination of signals, such as a pair of stereo signals with numerous effects. 2. The act of creating such a combination. 3. A type of bus. See *Bus*.

Mix bay: Control area for outputs and groups.

Mixer: 1. A console or other device that blends input signals into composite signals for output. 2. An engineer/technician who carries this out, especially during a live performance.

mm: Symbol for “millimetre” (one thousandth of a metre).

MON: Abbreviation for “monitor”, used to describe a control centre being used to mix the signals sent to the stage monitor speakers.

Monitor: 1. Speaker(s) used for listening to a mix or live audio. 2. The act of listening to a mix or live audio.

Monitor A: Primary monitor bus system.

Monitor B: Secondary monitor bus system.

Monitors: Control area on the master bay for monitoring the A and B signal paths.

Mono: A single signal.

Mute: Function that allows a channel’s signal to be silenced.

Mute safe: Function that means a mute cannot be controlled by scene recall or auto-mutes.

N

N/A: Abbreviation for “not applicable”.

nm: Symbol for nanometre (one billionth of a metre).

Normalise: To boost the amplitude of a digital sound so that it is as high as it can be without clipping (0dB).

Normalisation: An automatic process whereby the gain of all program material is adjusted so that the peak level will just arrive at 0dB.

Normalised connection: Also known as “normalised connection”. A connection that allows a signal to pass through it when no plug is inserted in it, but breaks the connection when a plug is inserted.

Normalising: The process of making audio files the same volume.

NVRAM: Abbreviation for “Non-volatile random access memory”. This is the general name used to describe any type of RAM that retains its information when power is switched off. For example, flash memory.

O

O/B: Abbreviation for “outside broadcast”.

Oct: Abbreviation for “octave”.

Octave: A difference in pitch where one tone has a frequency that is double or half of the frequency of another tone.

ohm (Ω): Unit of electrical resistance.

OpticalCon®: A cable connector for fibre optic cables.

OS: Abbreviation for “operating system”.

OSC: Abbreviation for “oscillator” or “oscillation”.

Out of phase: 1. A signal, being similar to another in amplitude, frequency and wave shape, but offset in time by part of a cycle.
2. 180° out of phase or having opposite polarity. See *Phase*.

Outboard: External, as in an “external device”.

Outboard equipment: External equipment used with the PRO Series Control Centre, but that is not part of it.

Output: 1. The signal put out by a device.
2. The physical location of where a device sends out a signal.

Output fast strip: One of 16 channel strips in the output fast zone. Provides detailed control of the currently selected outputs. See *Output fast zone*.

Output fast zone: Control area for fast access to primary main output functions.

Overload: A condition where the signal level is too high.

Overview: The main view in the GUI channel strip, which contains the control sections of the selected channel. This represents the associated channel strip on the control surface.

Overview screen: One of the GUI screens. This is the default screen of the mix bay.

P

PAN: Abbreviation for “panoramic”.

Panning: The left/right positioning of a signal across a stereo image.

Parameter: A setting whose value can be altered by the user.

Parametric EQ: A type of EQ that allows all of the parameters of equalisation to be changed, including centre frequency, boost/cut in gain and bandwidth.

Patch: A temporary connection (physical or virtual) made between two audio devices or inside one.

Patch connector: Any tab patching point, for example, an XLR connector, bus, sidechain compressor etc. See *Patching*.

Patching: Also known as “soft patching”. The process of routing a channel/signal from a source to a destination(s).

PCB: Abbreviation for “printed circuit board”.

PEQ: Abbreviation for “parametric equaliser”. See *Parametric EQ*.

PFL: Abbreviation for “pre-fade listen”. A function that allows the signal to be monitored pre-fader, that is, before it reaches the fader.

Phantom power: The power required for the operation of a condenser microphone when it is not supplied by internal batteries or a separate power supply. This is supplied by the PRO Series Control Centre itself.

Phase: A measurement (in degrees) of the time difference between two waveforms.

Pitch: A continuous frequency over time. Musical interpretation of an audio frequency.

Pitch shift: Alteration of pitch or frequency, but without adjusting tempo.

Point scene: Subdivision of a scene. See *Scene*.

Pointer: 1. On the GUI, the pointer is the arrow-shaped object on the screen that moves when the user moves the trackball or external mouse.
2. On a control knob, it is the marking that, when used in conjunction with the ident around edge of control knob, helps to indicate the setting.

POP: Abbreviation for “population”.

POP group: A number of channels assigned to a group that has unfold and area B controls. Provides an easy and quick method of manipulating and controlling the numerous channels available on the PRO Series Control Centre.

Post-: The point for accessing audio just after it leaves a specific channel component, for example, “post-fader”, where the audio is tapped from just after it leaves the channel's main level control.

Pre-: The point for accessing audio just before it reaches a specific module, for example, “pre-EQ”, where the audio is tapped from just before it gets to a channel strip's EQ.

Primary navigation zone: Area in the master bay for mix and master bay GUI screen navigation and control. Also has a **screen access** section for fast access to GUI menu options.

Processing area: A display in a GUI channel strip showing a specific control section. Accessed from the channel's overview display. See *Overview*.

PSU: Abbreviation for “power supply unit”.

Psychoacoustics: The study of the perception of sound, that is, how we listen, our psychological responses and the physiological effects on the human nervous system.

Psychoacoustic noise: Noise that affects the physiology of the listener.

Q

Quick access button: Button for navigation/selection of a channel/bus/processing area.

R

RAM: Abbreviation for "Random access memory".

Return: Auxiliary return or aux return. An extra input used for receiving a signal from the output of an internal or external effect processor. See *Bus*.

Reverb: An effect where the ambience of a physical space is simulated. This is done by copying a signal and replaying at regular intervals at ever decreasing levels. The intervals are so close that each copy is not heard individually.

RMS: Abbreviation for "root-mean-square". The square root of the mean of the sum of the squares. Commonly used as the effective value of measuring a sine wave's electrical power. A standard in amplifier measurements. The effective average value of an AC waveform.

RS: Abbreviation for "right surround". The right-hand rear speaker in a 5.1 surround system.

S

s: Symbol for "second". A unit of time.

Scene: In automation, a set of mix settings for a particular part of a performance, for example, a play or song.

Sibilance: Energy from a voice, centred around 7kHz, and caused by pronouncing "s", "sh" or "ch" sounds.

Side chain: A special circuit that diverts a proportion of the main signal so that it can be processed, as required. Compressors use the side chain to derive their control signals.

Signal flow: The path of a signal from one place to another.

SIP™: Abbreviation for "solo in place".

SIS: Abbreviation for "spatial imaging system". Combines a central loudspeaker cluster with a left-right system to form three discrete sound channels.

Snapshot: A captured group of mixer settings that reflect the state of the mixer at a particular

moment within a performance. This snapshot can then be recalled at the required moment in the performance/playback.

Solo: During monitoring, the isolation of one signal by silencing all other signals.

Source: The patch connector from which a signal is patched. See *Patching*.

SPL: Abbreviation for "sound pressure level". Given in decibels (dB), SPL is an expression of loudness or volume.

Splash screens: The GUI display during power up.

SRC: Abbreviation for "sample rate converter".

SSD: Abbreviation for "solid-state disk". Data storage device that uses non-volatile memory to store data. Quicker than the conventional hard disk and less susceptible to the failures associated with hard disk drives.

Status indicator: A device specifically designed to show the condition of something. For example, an LED that shows whether a pushbutton is on or off, or a meter showing the level of a signal.

Stereo: Two separate channels, left and right, used to give the listener the perception of where the noise is coming from. Usually used with music to give a fuller, more natural sound.

Stereo image: The perception of the different sound sources coming from far left, far right or anywhere in between.

Surround: Audio that has more than two speaker locations and, therefore, more than two channels. Also commonly termed "surround sound".

Synchronisation (sync): Coordination of timing between devices.

T

Tab: A 'sheet' in the **From** and **To** sections that contains a specific group of patch connectors. See *Patching*.

TFT: Abbreviation for "thin film transistor".

Threshold: Level at which dynamics processing will begin to operate.

Tie line: A dedicated connection between two systems, typically between FOH and MON positions.

To section: The rightmost area of the Patching screen that contains the destination patch connectors. See *Patching*.

Tooltip: The information box that appears next to the pointer when it passes over or pauses on items on certain GUI screens, such as the channels on the **Overview** and **Patching** screens.

Touchpad: Also known as “trackpad”. An input device on a laptop PC for controlling the on-screen pointer.

Track: Single stream of recorded audio data.

Trackball: Device, located in the primary navigation zone, for GUI screen navigation and control of the mix and master bays.

Treble: Higher frequencies in a signal.

TW: Abbreviation for “twin-wire”.

U

Unbalanced audio: A type of audio connection that utilises only two of the leads of a cable, connector and jack.

Unfold: Navigates the input channels of a group to the input bays.

USB: Abbreviation for “universal serial bus”. A ‘plug and play’ interface that provides a fast connection between a computer and peripherals, such as keyboards, printers, scanners, digital cameras etc.

V

VCA: Abbreviation for “variable control association” (also “voltage controlled amplifier”).

VCA fader: The fader control of a VCA group.

VCA group: A group of channels that are controlled globally, such as via their group’s fader and other controls. Provides an easy and quick method of manipulating and controlling the numerous channels available on the PRO Series Control Centre.

VGA: Abbreviation for “video graphics array”. A graphics display system for PCs developed by IBM.

Virtual rack: A traditional 19” rack, represented on the GUI. A virtual rack will, typically, contain internal devices, such as effects and GEQs.

Volt (V): A unit of electrical potential differential or electromotive force.

Volume: General term for a signal’s loudness.

W

Window: A small self-contained panel that appears on the GUI, usually after selection of a specific control. Typically, contains a number of user-selectable options or information in the form of a message or prompt.

X

X-over: Abbreviation for “crossover”.

XLR connector: High-quality three-pin audio connector, which is also used for AES/EBU digital audio connections.

Thank you for reading through this Owner's Manual.
We hope you found it useful.

Please feel free to send us your comments.
Our contact details and website address can be found
at the front of this manual.



Midas Klark Teknik Limited
Klark Industrial Park, Walter Nash Road,
Kidderminster. Worcestershire. DY11 7HJ. England.
Tel: +44 1562 741515, Fax: +44 1562 745371
Email: info@midasklarktechnik.com
Website: www.midasconsoles.com