

# ZLX Portable Loudspeaker Series

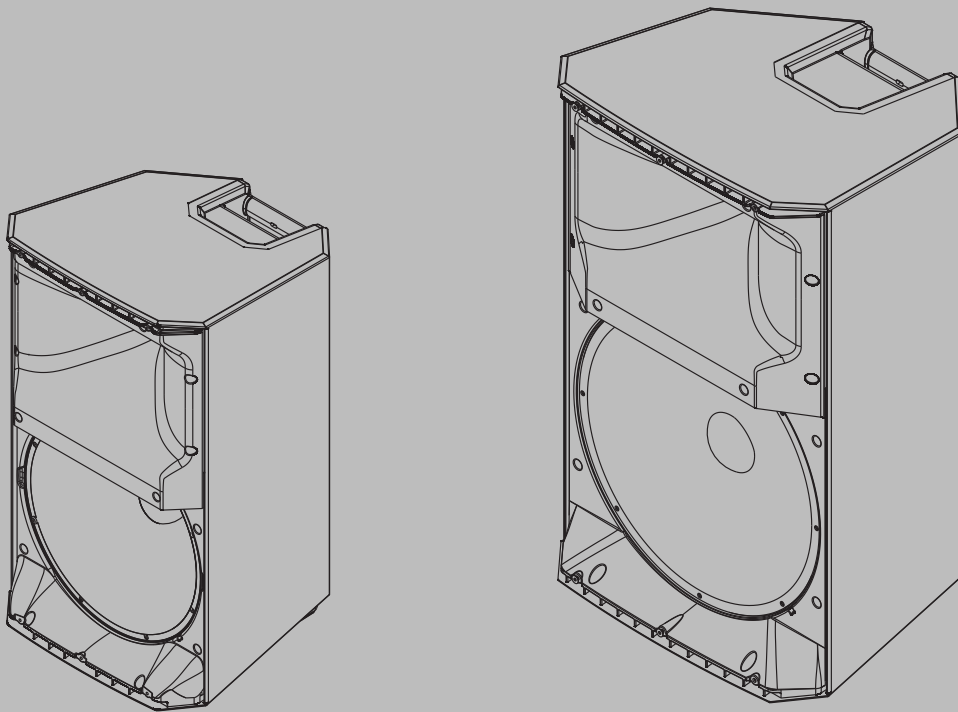



## Table of contents





|          |  |           |
|----------|--|-----------|
| <b>1</b> | <b>Safety</b>  | <b>4</b>  |
| 1.1      | Important safety instructions                          | 4         |
| 1.2      | Suspension   | 5         |
| 1.3      | FCC Information  | 5         |
| 1.4      | Precautions  | 6         |
| 1.5      | Certifications   | 7         |
| 1.6      | Notices  | 8         |
| <b>2</b> | <b>Description</b>                                     | <b>10</b> |
| 2.1      | Short information                                      | 10        |
| 2.2      | System features  | 10        |
| 2.3      | Quick setup  | 12        |
| 2.4      | Quick setup – wireless streaming                       | 13        |
| <b>3</b> | <b>Tripod, pole mount, and floor monitor operation</b> | <b>14</b> |
| 3.1      | Tripod or pole mount                                   | 14        |
| 3.2      | Floor monitor  | 16        |
| <b>4</b> | <b>Amplifier DSP</b>                                   | <b>17</b> |
| 4.1      | Amplifier DSP controls                                 | 17        |
| 4.2      | System status  | 18        |
| 4.3      | DSP controls   | 20        |
| 4.3.1    | DSP control menu                                       | 20        |
| <b>5</b> | <b>Recommended configuration</b>                       | <b>26</b> |
| 5.1      | Powered loudspeakers                                   | 26        |
| 5.1.1    | Daisy-chaining full-range systems                      | 26        |
| 5.1.2    | MP3 player MONO configuration                          | 27        |
| 5.1.3    | Using full-range systems as monitors                   | 28        |
| 5.1.4    | Stacking full-range systems with subwoofers            | 29        |
| 5.1.5    | Wireless audio STEREO configuration                    | 30        |
| 5.2      | Passive loudspeakers                                   | 31        |
| 5.2.1    | Basic stereo system using full-range systems           | 31        |
| 5.2.2    | Using full-range systems as stage monitors             | 32        |
| 5.2.3    | Stacking full-range systems with subwoofers            | 33        |
| <b>6</b> | <b>Troubleshooting</b>                                 | <b>34</b> |
| <b>7</b> | <b>Technical data</b>                                  | <b>37</b> |
| 7.1      | Dimensions   | 41        |
| 7.2      | Frequency response                                     | 42        |

# 1

## Safety

### 1.1

### Important safety instructions

|  |   |  |
|--|---|--|
|  <p><b>WARNING:</b> TO REDUCE THE RISK OF FIRE OR ELECTRIC SHOCK, DO NOT OVEREXPOSE THIS APPLIANCE TO RAIN OR MOISTURE</p> <p><b>AVIS:</b> RISQUE DE CHOC ELECTRIQUE, NE PAS OUVRIR.</p> <p><b>WARNING:</b> THE MAINS PLUG OR AC INLET IS USED AS A DISCONNECT DEVICE. THE DISCONNECT DEVICE SHALL REMAIN READILY OPERABLE.</p> <p><b>WARNING:</b> CONNECT ONLY TO MAINS SOCKET WITH PROTECTIVE EARTHING CONNECTION.</p> <p><b>WARNING:</b> TO REDUCE THE RISK OF ELECTRIC SHOCK, DO NOT REMOVE COVER (OR BACK) AS THERE ARE NO USER-SERVICABLE PARTS INSIDE. REFER SERVICING TO QUALIFIED PERSONNEL.</p> |  | <p>The lightning flash with arrowhead symbol, within an equilateral triangle is intended to alert the user to the presence of uninsulated “dangerous voltage” within the product’s enclosure that may be sufficient magnitude to constitute a risk of electric shock to persons.</p> |
|  |  | <p>The exclamation point within an equilateral triangle is intended to alert the user to the presence of important operating and maintenance (servicing) instructions in the literature accompanying the appliance.</p>  |
|  |  | <p>The asterisk within an equilateral triangle is intended to inform the user to necessary installation or removal instructions regarding equipment or hardware use relating to the system.</p>  |
|  |   |  |

1. Read these instructions.
2. Keep these instructions.
3. Heed all warnings.
4. Follow all instructions.
5. Do not use this apparatus near water.
6. Clean only with a dry cloth.
7. Do not block any ventilation openings. Install in accordance with the manufacturer's instructions.
8. Do not install near any heat sources such as radiators, heat registers, stoves, or other apparatus (including amplifiers) that produce heat.
9. Do not defeat the safety purpose of the polarized or grounding-type plug. A polarized plug has two blades with one wider than the other. A grounding type plug has two blades and a third grounding prong. The wide blade or the third prong is provided for your safety. If the provided plug does not fit into your outlet, consult an electrician for replacement of the obsolete outlet.
10. Protect the power cord from being walked on or pinched particularly at plugs, convenience receptacles, and the point where they exit from the apparatus.
11. Only use attachments/accessories specified by the manufacturer.
12. Use only with the cart, stand, tripod, bracket, or table specified by the manufacturer, or with the apparatus. When a cart is used, use caution when moving the cart/apparatus combination to avoid injury from tip-over.
13. Unplug the apparatus during lightning storms or when unused for long periods of time.

14. Refer all servicing to qualified service personnel. Servicing is required when the apparatus has been damaged in any way, such as power-supply cord or plug is damaged, liquid has been spilled or objects have fallen into the apparatus, the apparatus has been exposed to rain or moisture, does not operate normally, or has been dropped.
15. No naked flame sources, such as lighted candles, should be placed on the apparatus.
16. To reduce the risk of fire or electric shock, do not expose this apparatus to rain or moisture. The apparatus should not be exposed to dripping or splashing. Objects filled with liquids, such as vases should not be placed on apparatus.
17. Do not block any ventilation openings. Install in accordance with the manufacturer's instructions.
18. Minimum 60 cm (2 ft) distances around the apparatus for sufficient ventilation.
19. The ventilation should not be impeded by covering the ventilation openings with items, such as newspapers, table-cloths, curtains, etc.
20. To completely disconnect AC power from this apparatus, the power supply cord must be unplugged.

## 1.2 Suspension

### Warning!



Suspending any object is potentially dangerous and should only be attempted by individuals who have a thorough knowledge of the techniques and regulations of suspending objects overhead. Electro-Voice strongly recommends all loudspeakers be suspended taking into account all current national, federal, state, and local laws and regulations. It is the responsibility of the installer to ensure all loudspeakers are safely installed in accordance with all such requirements. When loudspeakers are suspended, Electro-Voice strongly recommends the system be inspected at least once per year or as laws and regulations require. If any sign of weakness or damage is detected, remedial action should be taken immediately. The user is responsible for making sure the wall, ceiling, or structure is capable of supporting all objects suspended overhead. Any hardware used to suspend a loudspeaker not associated with Electro-Voice is the responsibility of others.

### Warning!



Do not suspend this product in any other manner than explicitly described in this manual, or Electro-Voice installation guides. Suspending any object (loudspeaker) is potentially dangerous and should only be done by individuals with thorough knowledge of techniques, materials, and regulations for suspending objects overhead. Electro-Voice loudspeakers can only be suspended using accessories and hardware described in Electro-Voice manuals and installation guides. **Do NOT use handles to suspend the loudspeaker. Handles on Electro-Voice loudspeakers are intended to only be used for temporary transport by people. Items, such as fiber rope, wire rope, cables, or other types of materials cannot be used to suspend loudspeaker from the handles.** Any hardware used to suspend a loudspeaker not associated with Electro-Voice is the responsibility of others.

## 1.3 FCC Information

This device complies with Part 15 of the FCC Rules. Operation is subject to the following two conditions:

- (1) This device may not cause harmful interference, and
- (2) This device must accept any interference received, including interference that may cause undesired operation.



### Notice!

This product has been tested and found to comply with the limits for a Class B digital device, pursuant to Part 15 of the FCC Rules. These limits are designed to provide reasonable protection against harmful interference in a residential installation. This product generates, uses, and can radiate radio frequency energy and, if not installed and used in accordance with the instructions, may cause harmful interference to radio communications.

However, there is no guarantee that interference will not occur in a particular installation. If this product does cause harmful interference to radio or television reception, which can be determined by turning the equipment off and on, the user is encouraged to try to correct the interference by one or more of the following measures:

- Reorient or relocate the receiving antenna.
- Increase the separation between the equipment and receiver.
- Connect the equipment into an outlet on a circuit different from that to which the receiver is connected.
- Consult the dealer or an experienced radio/TV technician for help.

Please take attention that changes or modification not expressly approved by the party responsible for compliance could void the user's authority to operate the equipment.

This equipment should be installed and operated with a minimum distance 20cm between the radiator and your body

This device complies with Industry Canada license-exempt RSS standard(s). Operation is subject to the following two conditions:

- (1) this device may not cause interference, and
- (2) this device must accept any interference, including interference that may cause undesired operation of the device.

Le présent appareil est conforme aux CNR d'Industrie Canada applicables aux appareils radioexempts de licence. L'exploitation est autorisée aux deux conditions suivantes :

- (1) l'appareil ne doit pas produire de brouillage, et
- (2) l'utilisateur de l'appareil doit accepter tout brouillage radioélectrique subi, même si le brouillage est susceptible d'en compromettre le fonctionnement.

Under Industry Canada regulations, this radio transmitter may only operate using an antenna of a type and maximum (or lesser) gain approved for the transmitter by Industry Canada. To reduce potential radio interference to other users, the antenna type and its gain should be so chosen that the equivalent isotropically radiated power (e.i.r.p.) is not more than that necessary for successful communication.



Conformément à la réglementation d'Industrie Canada, le présent émetteur radio peut fonctionner avec une antenne d'un type et d'un gain maximal (ou inférieur) approuvé pour l'émetteur par Industrie Canada. Dans le but de réduire les risques de brouillage radioélectrique à l'intention des autres utilisateurs, il faut choisir le type d'antenne et son gain de sorte que la puissance isotrope rayonnée équivalente (p.i.r.e.) ne dépasse pas l'intensité nécessaire à l'établissement d'une communication satisfaisante.

## 1.4

### Precautions



If an Electro-Voice loudspeaker is used outdoors on a sunny day, place the loudspeaker in a shaded or covered area. The loudspeaker amplifiers have protection circuits that temporarily shut the loudspeaker off when extremely high temperatures are reached. This can happen on hot days when the loudspeaker is in direct sunlight.

|   |   |
|---|---|
|  | Do not use Electro-Voice loudspeakers in an environment where temperatures are below 0°C (32°F) or exceed +35°C (95°F).   |
|  | Never expose an Electro-Voice loudspeaker to rain, water, or high moisture.   |
|  | Electro-Voice loudspeakers are easily capable of generating sound pressure levels sufficient to cause permanent hearing damage to anyone within normal coverage distance. Caution should be taken to avoid prolonged exposure to sound pressure levels exceeding 90 dB. |

## 1.5

### Certifications

#### Brazil:

"Este equipamento não tem direito à proteção contra interferência prejudicial e não pode causar interferência em sistemas devidamente autorizados"

#### Mexico:

"La operación de este equipo está sujeta a las siguientes dos condiciones: (1) es posible que este equipo o dispositivo no cause interferencia perjudicial y (2) este equipo o dispositivo debe aceptar cualquier interferencia, incluyendo la que pueda causar su operación no deseada"

#### Singapore:

Complies with  
IMDA Standards  
DB101762

#### United Arab Emirates:

TRA Registered no.: ER70590/19

Dealer no.: DA45733/15

#### Republic of Korea:



R-C-B6S-ZLX

|                 |                              |
|-----------------|------------------------------|
| 제품명:            | 앰프내장형 스피커                    |
| 모델명:            | ZLX, ZLX-12BT, ZLX-15BT      |
| 정격:             | 100-240Vac, 50-60Hz, 1000W   |
| 수입업체(상호)명:      | 로버트보쉬코리아(유)                  |
| 제조사:            | Bosch Security Systems, Inc. |
| 제조연월:별도표기 제조국 : | 중국                           |
| A/S:            | 02-702-2845                  |

해당 무선설비는 운용 중 전파혼신 가능성이 있음

해당 무선설비는 전파혼신 가능성이 있으므로 인명안전과 관련된 서비스는 할 수 없습니다.

## 1.6



## Notices

### Old electrical and electronic appliances

Electrical or electronic devices that are no longer serviceable must be collected separately and sent for environmentally compatible recycling (in accordance with the European Waste Electrical and Electronic Equipment Directive).

To dispose of old electrical or electronic devices, you should use the return and collection systems put in place in the country concerned.

### Copyright and disclaimer

All rights reserved. No part of this document may be reproduced or transmitted in any form by any means, electronic, mechanical, photocopying, recording, or otherwise, without the prior written permission of the publisher. For information on getting permission for reprints and excerpts, contact Electro-Voice.

All content including specifications, data, and illustrations in this manual are subject to change without prior notice.



### Notice!

Bluetooth® is available in select countries.

Contact your nearest Electro-Voice dealer or Electro-Voice distributor for more information.

The Bluetooth® word mark and logos are registered trademarks owned by Bluetooth SIG, Inc. and any use of such marks by Bosch Security Systems, Inc. is under license. Other trademarks and trade names are those of their respective owners.



## For use in China: CHINA ROHS DISCLOSURE TABLE

针对在中国境内的使用：CHINA ROHS披露表

扬声器

| 根据SJ/T 11364-2014编制的有害物质表                   |            |            |            |                  |              |                |
|---|------------|------------|------------|------------------|--------------|----------------|
|   | Pb<br>(Pb) | Hg<br>(Hg) | Cd<br>(Cd) | Cr 6+<br>(Cr 6+) | PBB<br>(PBB) | PBDE<br>(PBDE) |
| 电路板   | ○          | ○          | ○          | ○                | ○            | ○              |
| 电子组件  | x          | ○          | ○          | ○                | ○            | ○              |
| 换能器   | x          | ○          | ○          | ○                | ○            | ○              |
| 显示屏   | x          | ○          | ○          | ○                | ○            | ○              |
| 电缆和导线                                       | ○          | ○          | ○          | ○                | ○            | ○              |
| 塑料材料  | ○          | ○          | ○          | ○                | ○            | ○              |
| 金属材料  | x          | ○          | ○          | ○                | ○            | ○              |
| 木质和纸质材料                                     | ○          | ○          | ○          | ○                | ○            | ○              |
| 涂料与涂层                                       | ○          | ○          | ○          | ○                | ○            | ○              |
| 本表系根据SJ/T 11364的规定编制而成                      |            |            |            |                  |              |                |
| ○：上述有害物质在所有包含该物质的均质材料中的含量均低于GB/T 26572规定的限值 |            |            |            |                  |              |                |
| x：上述有害物质在特定均质材料中的含量均高于GB/T 26572规定的限值       |            |            |            |                  |              |                |

关于该类产品生产日期代码的详细说明，请见：

<http://www.boschsecurity.com/datecodes/>

## 2 Description

Thank you for choosing an Electro-Voice portable loudspeaker system. Please take time to consult the manual to understand all the features built into your EV system and fully utilize its performance capabilities.

ZLX portable loudspeakers offer the best performance and reliability in their class - with components and engineering that work together to make it quicker and easier than ever to take control of your sound, whatever the gig.

*Bluetooth® is available in select countries.*

### 2.1 Short information

The following table lists products in a family, with CTN (Commercial Type Number) and identifying product name DESCRIPTION.

| CTN         | Description                         |
|-------------|-------------------------------------|
| ZLX-12P-AX  | 12" 2-way powered speaker, EU cord  |
| ZLX-12P-EX  | 12" 2-way powered speaker, EU cord  |
| ZLX-12P-US  | 12" 2-way powered speaker, US cord  |
| ZLX-12BT-EU | 12" 2-way powered speaker BT EUcord |
| ZLX-12BT-US | 12" 2-way powered speaker BT UScord |
| ZLX-15P-AX  | 15" 2-way powered speaker, EU cord  |
| ZLX-15P-EX  | 15" 2-way powered speaker, EU cord  |
| ZLX-15P-US  | 15" 2-way powered speaker, US cord  |
| ZLX-15BT-EU | 15" 2-way powered speaker BT EUcord |
| ZLX-15BT-US | 15" 2-way powered speaker BT UScord |
| ZLX-12      | 12" 2-way passive speaker           |
| ZLX-15      | 15" 2-way passive speaker           |

### 2.2 System features

#### ZLX-12BT and ZLX-15BT—Powered Loudspeaker Systems

Now with Bluetooth® enabled wireless audio streaming, legendary ZLX performance becomes even more convenient with the ability to connect to any mobile device for streaming your music library.

Featuring custom drivers housed in an innovative cabinet design, the two new wireless, compact, and versatile ZLX models make EV's renowned sound quality and rugged reliability more accessible than ever before.

- High-quality Bluetooth® audio streaming for background music or musical accompaniment. *Bluetooth® connectivity is available in select countries.*
- Quick**Smart**DSP features best-in-class processing. Easy setup via four presets, sub/top system-match, two-band EQ, five user-programmable presets, visual monitoring of limiter status, input level control and meters, and master volume control to optimize gain structure, all via LCD.
- High-efficiency 1000 W Class-D power amplifier delivers us to 127 dB peak SPL utilizing transducers designed and engineered by EV.

- EV-patented Signal Synchronized Transducers (SST) waveguide design provides precise and consistent coverage, minimal distortion, and maximized acoustical loading.
- Three optimally located handles combined with a rugged composite structure provides the most portable professional sound speaker on the market.

### **ZLX-12P and ZLX-15P—Powered Loudspeaker Systems**

The only loudspeaker in its class that matches EV-engineered drivers with a custom-built Class-D amplifier module and powerful DSP. Whether pole-mounted or used as a floor monitor, ZLX delivers stunning sonic impact and intelligibility—the legendary “EV Sound” the pros trust.

- ZLX-12P: 50 Hz - 20 kHz; 126 dB max SPL; 1000 W (Class D).
- ZLX-15P: 42 Hz - 20 kHz; 127 dB max SPL; 1000 W (Class D).
- 12 inch and 15 inch woofer for low-end punch in a compact enclosure and 1.5 inch high-frequency titanium compression driver.
- LCD display and 1-knob DSP control with presets for precise and speedy setup.
- Input level meters and independent amplifier control to ensure optimal gain structure.
- Front LED for power on and limit indication.
- Patented split-baffle design for superior driver time alignment.
- Durable composite construction with innovative hi/lo grip design for easy pole mounting.
- LCD display allows for application and location EQ optimization.
- Innovative industrial design allows for professional look to match professional sound.
- Three handles including hi/lo grip ultimately makes for the most portable professional sound speaker on the market.
- Composite structure is built to last and provides road tested ruggedness.

EV offers the best-in-class sound, design, and control using LCD controlled DSP that is inspired by concert tour grade products.

### **ZLX-12—12 inch Passive Loudspeaker System**

A compact and versatile loudspeaker featuring EV-engineered drivers in a rugged enclosure. Whether pole-mounted or used as a floor monitor, ZLX delivers stunning sonic impact and intelligibility—the legendary “EV Sound” the pros trust.

- 12 inch woofer for low-end punch in a compact enclosure and 1.5 inch high-frequency titanium compression driver.
- Durable composite construction with innovative hi/lo grip design for easy pole mounting.
- Exclusive split-baffle design for superior driver time alignment.
- 55 Hz - 20 kHz frequency range.
- 250 W Continuous, 1000 W Peak power handling.
- 95 dB SPL sensitivity; 125 dB max SPL.

### **ZLX-15—15 inch Passive Loudspeaker System**

A compact and versatile loudspeaker featuring EV-engineered drivers in a rugged enclosure. Whether pole-mounted or used as a floor monitor, ZLX delivers stunning sonic impact and intelligibility—the legendary “EV Sound” the pros trust.

- 15 inch woofer for extended low-frequency response and 1.5 inch high-frequency titanium compression driver.
- Durable composite construction with innovative hi/lo grip design for easy pole mounting.
- Exclusive split-baffle design for superior driver time alignment.
- 44 Hz - 20 kHz frequency range.
- 250 W Continuous, 1000 W Peak power handling.
- 96 dB SPL sensitivity; 126 dB max SPL.





## 2.3 Quick setup

The ZLX series loudspeakers from Electro-Voice are fully integrated audio systems with carefully matched electronics and transducers. These products make it easy to setup a high quality sound system quickly with a minimum amount of cables and external electronics.

### Full-Range powered loudspeaker

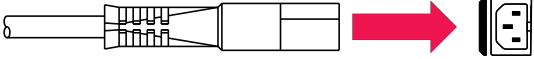
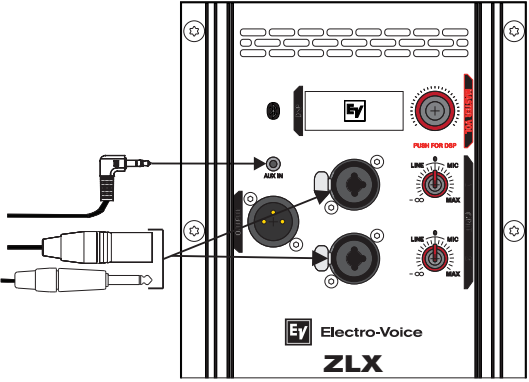
Models: ZLX-12P , ZLX-12BT, ZLX-15P, and ZLX-15BT

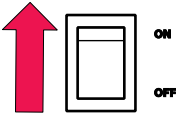
To set up a full-range powered loudspeaker, do the following:

| Step  | Illustration  |
|---|---|
| 1. Connect the AC power cord from a grounded line receptacle to the MAINS IN.                         |     |
| 2. Connect the 3.5 mm mini jack, XLR or TRS cable from an audio source to AUX IN, INPUT 1 or INPUT 2. |    |
| 3. Adjust the input gain to $-\infty$ (infinity).   |  |
| 4. Switch POWER to ON.  |  |
| 5. From the DSP home screen, increase the input gain to the desired signal level.                     |  |
| 6. Adjust the MASTER VOL knob to the desired volume.  |  |

### See also

- *Amplifier DSP controls, page 17*

## 2.4 Quick setup – wireless streaming

### Wireless streaming

For ZLX-12BT and ZLX-15BT models, follow these instructions to quickly and correctly pair and tune your system for wireless streaming from a Bluetooth® enabled mobile device.

To pair the system for wireless streaming, do the following:

1. Using the MASTER VOL knob, turn the output gain LEVEL down to MUTE.
2. Push the MASTER VOL knob.  
The DSP Control menu appears.
3. Using the MASTER VOL knob, scroll to STREAMING.
4. Push the MASTER VOL knob to select STREAMING.  
The focus moves to the parameters on the right side of the DSP menu.
5. Using the MASTER VOL knob, scroll to PAIRING mode.
6. Push the MASTER VOL knob to select PAIRING.  
The setting is saved. The focus returns to the menu items on the left side of the DSP menu.
7. Within 120 seconds, follow the manufacturer's instructions on your mobile device to pair with a Bluetooth® device.  
The loudspeaker appears as EV ZLX BT on your mobile device.

### Gain structuring

After pairing your mobile device with the system, you can set the volume for your streaming device.

To set the volume for your streaming device, do the following:

1. Set the loudspeaker output gain to MUTE.
2. Start playing music from your desired player/source.
3. Increase the volume on your mobile device.  
The BT VU meter on the ZLX loudspeaker's LCD responds to the incoming signal.
4. Increase the volume from your device until the BT VU meter is ~75% full.  
Take note of the volume slider on your mobile device as well: to prevent clipping, do not go past this level.
5. Using the MASTER VOL knob, increase the output gain to the desired listening level.  
Be mindful of the CLIP and LIMIT notifications.
6. Turn the level down on your mobile device for convenient volume control (optional).  
To prevent clipping, do not exceed the level previously observed (~75% BT VU).

### See also

- *DSP controls, page 20*

## 3 Tripod, pole mount, and floor monitor operation

### 3.1 Tripod or pole mount

ZLX portable loudspeakers mount on a tripod stand or on a pole above a subwoofer.

#### Mounting a loudspeaker on a tripod stand

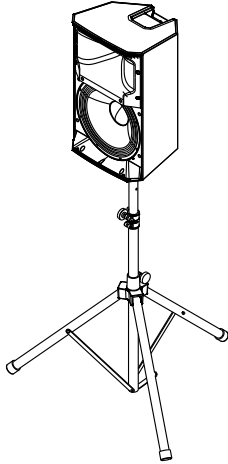

Figure 3.1: Full-Range models on a tripod stand



#### Caution!

Tripod is not evaluated for safety with this loudspeaker. Check the specifications of the tripod stand to be certain it is capable of supporting the weight of the loudspeaker.



#### Caution!

We recommend that two or more persons lift and place heavier loudspeakers. Single person lift and placement of heavier loudspeakers could cause injury.

To mount a loudspeaker on a tripod stand, do the following:

1. Place the tripod stand on a level and stable surface.
  - Fully extend the legs on the tripod stand.
  - Do not compromise the tripod stands structural integrity by trying to make the stand taller.
  - Do not attempt to suspend more than one loudspeaker on a stand designed for a single loudspeaker.
2. Using two hands lift the loudspeaker.
3. Set the pole cup located on the bottom of the loudspeaker onto the pole.

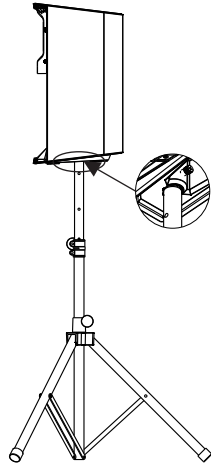

### Mounting a loudspeaker on a pole

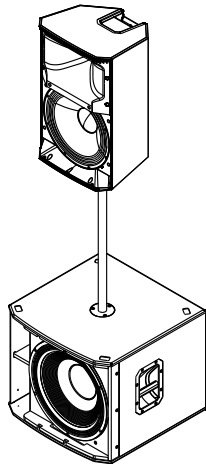

#### Caution!

We recommend that two or more persons lift and place heavier loudspeakers. Single person lift and placement of heavier loudspeakers could cause injury.

To mount a loudspeaker on a pole, do the following:

1. Place the subwoofer on a level stable surface.
2. Insert the pole into the pole cup on the top of the subwoofer.
3. If you are using a threaded pole mount, turn the pole clockwise to secure the pole to the subwoofer.  
OR  
If you are not using a threaded pole mount, continue to the next step.
4. Using two hands lift the loudspeaker.
5. Set the pole cup located on the bottom of the loudspeaker onto the pole.

## 3.2 Floor monitor

ZLX portable loudspeakers may be used as a floor monitor by placing the loudspeaker on the integral monitor angle.

### Setting up as a floor monitor

To set up a loudspeaker as a floor monitor, do the following:

1. Place the loudspeaker on a level and stable surface.
2. Safely route cables to prevent injury to performers, production crew, and audience members.



### Notice!

Secure cables with wire ties or tape whenever possible.

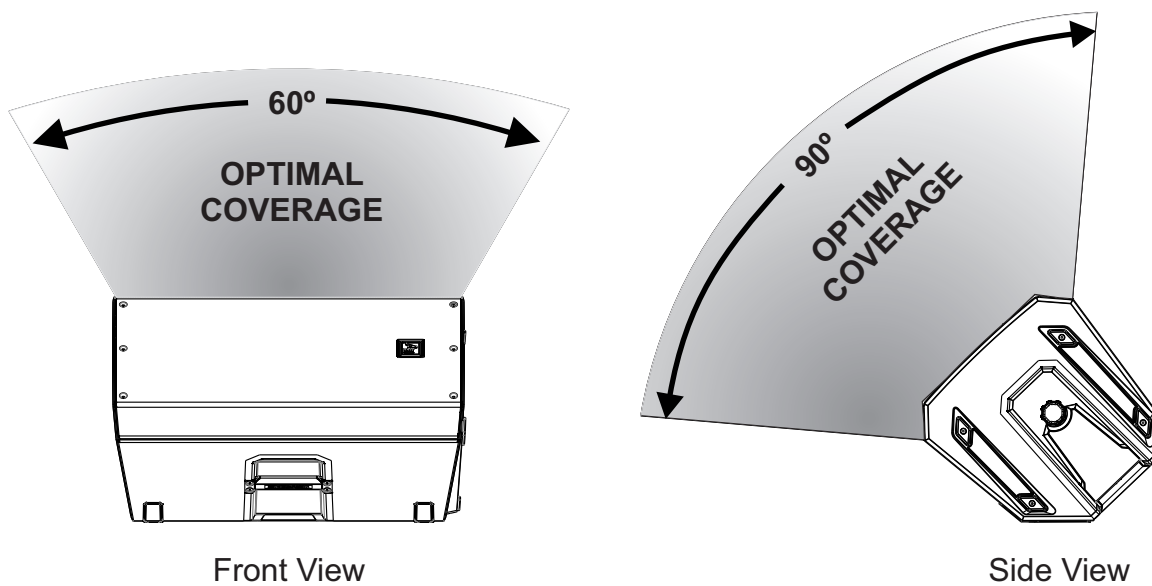

Figure 3.2: Optimum coverage in monitor position



## 4 Amplifier DSP

### 4.1 Amplifier DSP controls

The amplifier has a combination of controls and connectors to ensure the most versatile loudspeaker system.

#### Full-Range loudspeaker control and monitoring interface

The full-range loudspeaker DSP control menu selections are available for the powered ZLX loudspeakers.

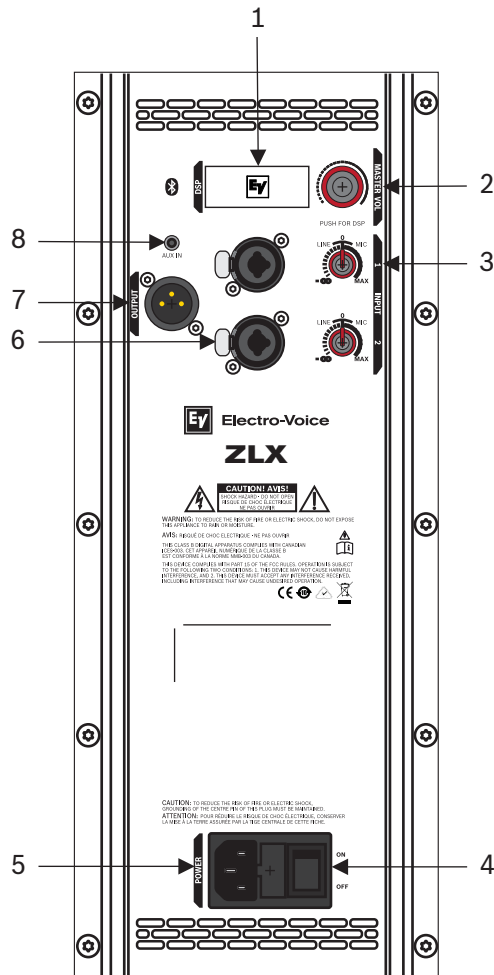

Figure 4.1: Full-Range loudspeaker amplifier panel

1. **LCD** - DSP control and monitoring interface.
2. **MASTER VOL** - Adjusts the sound level.  
**DSP** - Scroll through the menu and select the available choices. Push the MASTER VOL knob to enter the DSP menu.
3. **INPUT LEVEL** - Level control for adjusting the individual inputs' level. The 12 o'clock position is unity gain (no gain or attenuation), the range to the left of zero is for adjusting line level sources, and the range to the right of zero (0) is for adjusting microphone levels. LINE and MIC input level control is available for both INPUT 1 and INPUT 2.
4. **POWER** - AC switch or switching the power ON or OFF. The LCD screen lights up when the power is turned ON, after approximately 3 seconds.
5. **MAINS IN** - AC connection is established via an IEC-connector.

6. **INPUT** - Balanced input for the connection of signal sources like mixing consoles, instruments, or microphones. Connections can be established using ¼ inch TRS or XLR connectors.
7. **OUTPUT** - XLR output sends the mix of all input signals to another loudspeaker or subwoofer. INPUT LEVEL controls the signal level to OUTPUT. The MASTER VOL or DSP control settings do not affect OUTPUT. This is also the output for the BT signal which is configurable via the MIX OUT setting.
8. **AUX IN** - 3.5 mm audio jack input for connecting external audio media devices, such as MP3 players.

## 4.2

### System status

#### Normal

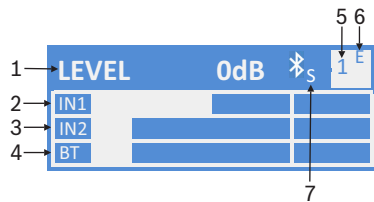

**Figure 4.2: Normal system status home screen with Bluetooth® status**

1. **LEVEL** – Indicates the master gain of the system in dB. The range is from mute to +10 dB, in 1 dB increments.
2. **IN1** – VU meter displays the signal level of INPUT 1 into the amplifier INPUT 1 XLR connector. IN1 and IN2 are independent of each other.
3. **IN2** – VU meter displays the signal level of INPUT 2 into the amplifier INPUT 2 XLR connector. IN1 and IN2 are independent of each other.
4. **BT** - VU meter displays the signal level of wireless audio input.
5. **1** - Indicates the selected store function number. There are five user defined store function numbers available.
6. **E** - Indicates the preset is not saved. When the preset is saved the E is not displayed.
7. **S** - Audio streaming; the available options are:  
 OFF - DISABLED  
 FLASHING - PAIRING MODE (120s)  
 SOLID - CONNECTED



#### Notice!

BT and S system statuses are available for ZLX-12BT and ZLX-15BT models only.



#### Notice!

Bluetooth® is available in select countries.

Contact your nearest Electro-Voice dealer or Electro-Voice distributor for more information.

### System protection

System protection limiters indicate when a system is exceeding recommended usage by indicating CLIP or LIMIT on the LCD display.

#### CLIP



Figure 4.3: Clipping system status

**CLIP** indicates the signal to the loudspeaker is too high, resulting in a clipped signal into the loudspeaker. If CLIP is shown, reduce the input gain knob and/or the signal on the mixer or source equipment.

#### LIMIT



OR

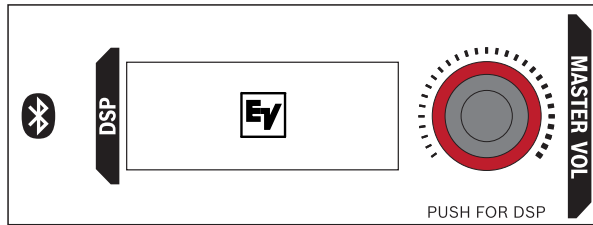

Figure 4.4: Limit system status

**LIMIT** protects the loudspeaker from short-term peaks which can cause distortion. When LIMIT is shown small on the screen, the limiter is active but keeps distortion under control. The large LIMIT indicates the sound is negatively affected. Reducing the output volume (MASTER VOL) is strongly recommended when the large limit indication is shown.

## 4.3 DSP controls

An integrated DSP control menu allows the user to select multiple DSP system settings on the loudspeaker.



To access the DSP controls menu, do the following:

1. Push the MASTER VOL knob.  
The DSP Control menu appears.

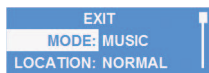

2. Using the MASTER VOL knob, scroll through the menu items.
3. Push the MASTER VOL knob to select the menu item you want to modify.  
The focus moves to the parameters on the right side of the DSP menu.

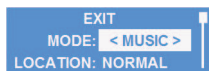

4. Using the MASTER VOL knob, scroll through the parameters.

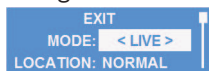

5. Push the MASTER VOL knob to confirm the selected parameter.  
The setting is saved. The focus returns to the menu items on the left side of the DSP menu.

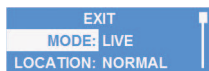

6. Repeat steps 2 through 5 to modify additional DSP and system settings.
7. Select EXIT to return to the home screen.

### 4.3.1 DSP control menu

The full-range loudspeaker DSP control menu selections are available for the powered ZLX loudspeakers.

|                 |                 |
|-----------------|-----------------|
| <b>EXIT</b>     |                 |
| <b>MODE</b>     | MUSIC (Default) |
|                 | LIVE            |
|                 | SPEECH          |
|                 | CLUB            |
| <b>LOCATION</b> | POLE (Default)  |
|                 | MONITOR         |
|                 | BRACKET         |
| <b>SUB</b>      | OFF (Default)   |

|   |                 |                           |
|---|-----------------|---------------------------|
|   |                 | 80Hz                      |
|   |                 | 100Hz                     |
|   |                 | 120Hz                     |
|   |                 | 150Hz                     |
|   |                 | ELX200-12SP               |
|   |                 | ELX200-18SP               |
|   |                 | EKX-15SP                  |
|   |                 | EKX-18SP                  |
|   |                 | ELX118P                   |
| <b>TREBLE</b>                               |                 | 0 db (Default)            |
|   |                 | -10 dB to +10 dB          |
| <b>BASS</b>                                 |                 | 0 db (Default)            |
|   |                 | -10 dB to +10 dB          |
| <b>MIX OUT</b>                              |                 | L + R (Default)           |
|   |                 | R                         |
| <b>LED</b>                                  |                 | ON (Default)              |
|   |                 | OFF                       |
|   |                 | LIMIT                     |
| <b>DISPLAY</b>                              | <b>LCD DIM</b>  | ON (Default)              |
|   |                 | OFF                       |
|   | <b>BRIGHT</b>   | 5 (Default)               |
|   |                 | 1 to 10                   |
|   | <b>CONTRAST</b> | 5 (Default)               |
|   |                 | 1 to 10                   |
| <b>STORE</b>                                |                 | EXIT, 1, 2, 3, 4, 5, EXIT |
| <b>RECALL</b>                               |                 | EXIT, 1, 2, 3, 4, 5, EXIT |
| <b>STREAMING</b><br>(ZLX-12BT and ZLX-15BT) |                 | OFF (Default)             |
|   |                 | PAIRING                   |
|   |                 | ON                        |
| <b>LOCK</b>                                 |                 | ON                        |
|   |                 | OFF (Default)             |
| <b>RESET</b>                                |                 | RESET ARE YOU SURE?       |
|   |                 | NO (Default)              |
|   |                 | YES                       |

|             |                     |
|-------------|---------------------|
| <b>INFO</b> | [PRODUCT NAME]      |
|             | [FIRMWARE VERSION]  |
|             | ©YYYY ELECTRO-VOICE |
| <b>EXIT</b> |                     |

**Tab. 4.1:** Full-Range Loudspeaker DSP Control Menu

### EXIT menu

The **Exit** menu is used to return to the home screen.



### Notice!

The display returns to the home screen after two minutes of inactivity.

### MODE menu

The **Mode** menu is used to configure the type of sound the loudspeaker delivers.

Available options for this selection are: MUSIC, LIVE, SPEECH and CLUB.

- **MUSIC** – is used for recorded music playback and electronic dance music applications. (Default)
- **LIVE** – is used for live sound applications.
- **SPEECH** – is used for spoken word applications.
- **CLUB** – is used for recorded electronic music playback.

### LOCATION menu

The **Location** menu is used to optimize the loudspeaker for different boundaries.

Available options for this selection are: POLE, MONITOR and BRACKET.

- **POLE** – is used when the loudspeaker is placed on a tripod stand or placed on a pole. (Default)
- **MONITOR** – is used when the loudspeaker is placed on the angled monitor panel in monitor position. This setting compensates for the amount of low frequency boost created by placing the speaker close to the floor.
- **BRACKET** – is used when the loudspeaker is mounted to the wall using the mounting bracket (Mounting Bracket accessory sold separately). This setting compensates for the amount of low frequency boost created by placing the loudspeaker close to the wall.

### SUB menu

The **Sub** menu is used to select a high pass frequency for use with a subwoofer or a matched subwoofer.

Available options for this selection are: OFF, 80Hz, 100Hz, 120Hz, 150Hz, ELX200-12SP, ELX200-18SP, EKX-15SP, EKX-18SP, and ELX118P. The high passes are 24 dB/octave Linkwitz/Riley crossovers. The 80 Hz, 100 Hz, 120 Hz, and 150 Hz choices are generic high pass settings for use with other subwoofers. The ELX200-12SP, ELX200-18SP, EKX-15SP, EKX-18SP, and ELX118P settings are specifically optimized for subwoofers by including delay for best summation.

### TREBLE menu

The **Treble** menu is used to adjust the high frequency performance of the loudspeaker for different applications or personal preference. The parameter controls a high shelving filter that is centered on 6 kHz.

The range is -10 dB to +10 db.

The default is zero.

#### **BASS menu**

The **Bass** menu is used to adjust the low frequency performance of the loudspeaker for different applications or personal preference. The parameter controls a parametric EQ filter that is centered on 60 Hz.

The default is zero.

#### **MIX OUT menu**

The **Mix Out** menu is used to select which channel of the BT signal should be output at MIX OUT and which channel should be delivered by the loudspeaker.

- L+R: The left and right signals of BT are summed. The sum is output at MIX OUT and is delivered by the loudspeaker. (Default)
- R: Only the right signal of BT is output at MIX OUT. The loudspeaker will deliver only the left signal.

#### **LED menu**

The **LED** menu shows power on and indicates limit. Available options for this selection are: ON, OFF or LIMIT.

- **ON** - turns the LED on when the power to the loudspeaker is ON. (Default)
- **OFF** - turns the LED off.
- **LIMIT** - turns the LED off under normal operation. The LED brief blinking indicates the limiter is activating. Short-term blinking is not critical because the integrated limiter keeps distortion under control. Constant lighting of the LED indicates the sound is negatively affected. If the LED is constantly lit, check the rear LCD for more information. Reducing the output volume is strongly recommended.

#### **LCD DIM menu**

The **LCD Dim** menu is used to dim the display when the display is idle for two minutes. Available options for this selection are: ON or OFF.

The default is ON.

#### **CONTRAST menu**

The **Contrast** menu is used to increase or decrease the visibility of the LCD screen.

The range is -10 dB to +10 db.

The default is zero.

#### **STORE menu**

The **Store** menu allows you create up to five customized user settings. Available options for this selection are: EXIT, 1, 2, 3, 4, and 5.



#### **Notice!**

The customized user setting name can contain a combination of alphanumeric characters including spaces. The alphanumeric character range is A to Z and 0-9.

The name field length is 12 characters.

To store customized user settings, do the following:

1. From the DSP menu, scroll to STORE.
2. Push the MASTER VOL knob to select STORE.

The store screen appears.



3. Push the MASTER VOL knob to select 1.  
The Enter name for 1 screen appears.
4. Use the MASTER VOL knob to scroll through the characters.

The characters appear.

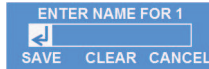

5. Push the MASTER VOL knob to select the desired character.
6. Turn the MASTER VOL knob to move to the next character entry.  
Continue selecting characters until the desired name is entered.



7. Use the MASTER VOL knob to scroll to SAVE.
8. Push the MASTER VOL knob to select SAVE.

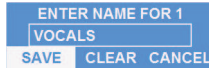

9. Repeat steps 3 through 8 to store additional customized user settings.
10. Select EXIT to return to the home screen.

### RECALL menu

The **Recall** menu allows you retrieve up to five customized user settings. Available options for this selection are: EXIT, 1, 2, 3, 4, and 5.

To recall customized user settings, do the following:

1. From the DSP menu, scroll to RECALL.
2. Push the MASTER VOL knob to select RECALL.  
The recall screen appears.
3. Push the MASTER VOL knob to select 1.  
The selected item is loaded.

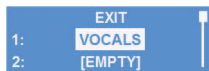

4. Select EXIT to return to the home screen.

### STREAMING

The **Streaming** menu is used to stream audio from your Bluetooth® enabled device to the loudspeaker system. Available options for this selection are: PAIRING, ON or OFF.

Streaming is available for ZLX-12BT and ZLX-15BT models only.

The default is OFF.

Pairing mode is enabled for 120 seconds.

### Pairing the loudspeaker with your Bluetooth® enabled device

To pair the loudspeaker with your Bluetooth® enabled device, do the following:

1. From the DSP menu, scroll to STREAMING.
2. Select PAIRING.  
PAIRING mode enables 120 seconds of visibility to Bluetooth® enabled devices.
3. On your mobile device, select EV ZLX BT to initiate the pairing process.  
Once the device is paired, all device audio will be output through the ZLX loudspeaker.

### LOCK menu

The **Lock** menu is designed to prevent users from inadvertently changing settings. Available options for this selection are: ON or OFF.

The default is OFF.

### RESET menu

The **Reset** menu is used to reset the loudspeaker to original factory settings. Available options for this selection are: NO or YES.

The default is NO.

To reset the system to original factory settings, do the following:



1. From the DSP menu, select RESET.  
The reset are you sure message appears.



2. Select YES.  
The loudspeaker restarts and resets the system to the original factory settings.



**Notice!**

Performing a reset erases the user customized settings saved under the STORE menu. The five user customized settings in the STORE and RECALL menus return to <EMPTY>.

**INFO menu**

The **Information** menu is used to display the product name and firmware version.

## 5 Recommended configuration

### 5.1 Powered loudspeakers

#### 5.1.1 Daisy-chaining full-range systems

LINE and MIC input level control is available for both INPUT 1 and INPUT 2. The 12 o'clock position is unity gain (no gain or attenuation) and the range to the right of zero (0) is for adjusting microphone levels.

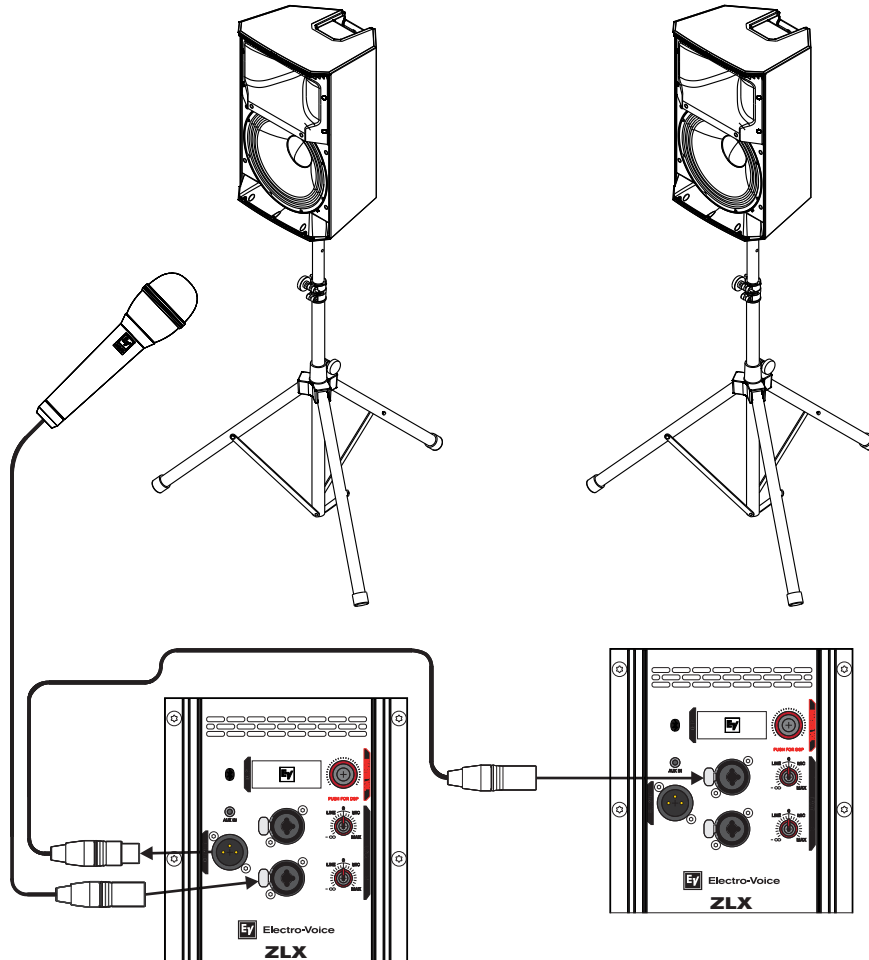

#### Notice!

The direction of the arrow indicates the signal path.

|                  |        |
|------------------|--------|
| <b>Mode:</b>     | Speech |
| <b>Location:</b> | Pole   |
| <b>Sub:</b>      | Off    |

**Tab. 5.2:** DSP settings loudspeaker on a tripod

#### See also

- *Tripod or pole mount, page 14*
- *Amplifier DSP, page 17*

### 5.1.2 MP3 player MONO configuration

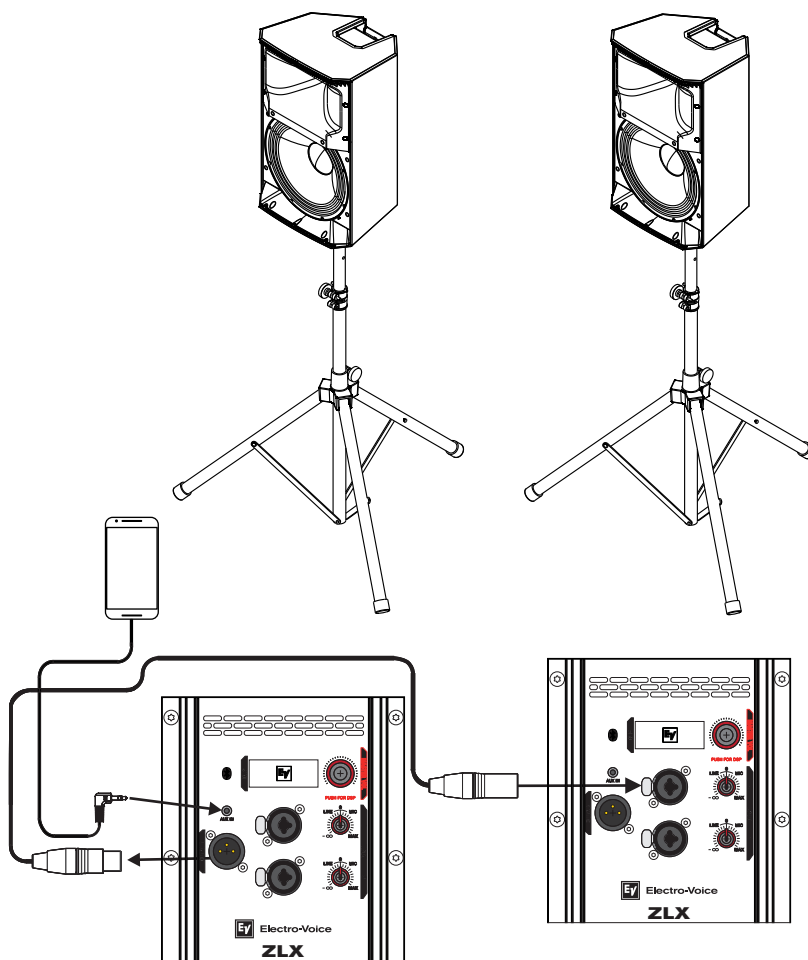

**Notice!**

The direction of the arrow indicates the signal path.

|                  |       |
|------------------|-------|
| <b>Mode:</b>     | Music |
| <b>Location:</b> | Pole  |
| <b>Sub:</b>      | Off   |

**Tab. 5.3:** DSP settings loudspeaker on a tripod

**See also**

- Tripod or pole mount, page 14
- Amplifier DSP, page 17

### 5.1.3 Using full-range systems as monitors

LINE and MIC input level control is available for both INPUT 1 and INPUT 2. The 12 o'clock position is unity gain (no gain or attenuation) and the range to the right of zero (0) is for adjusting microphone levels.

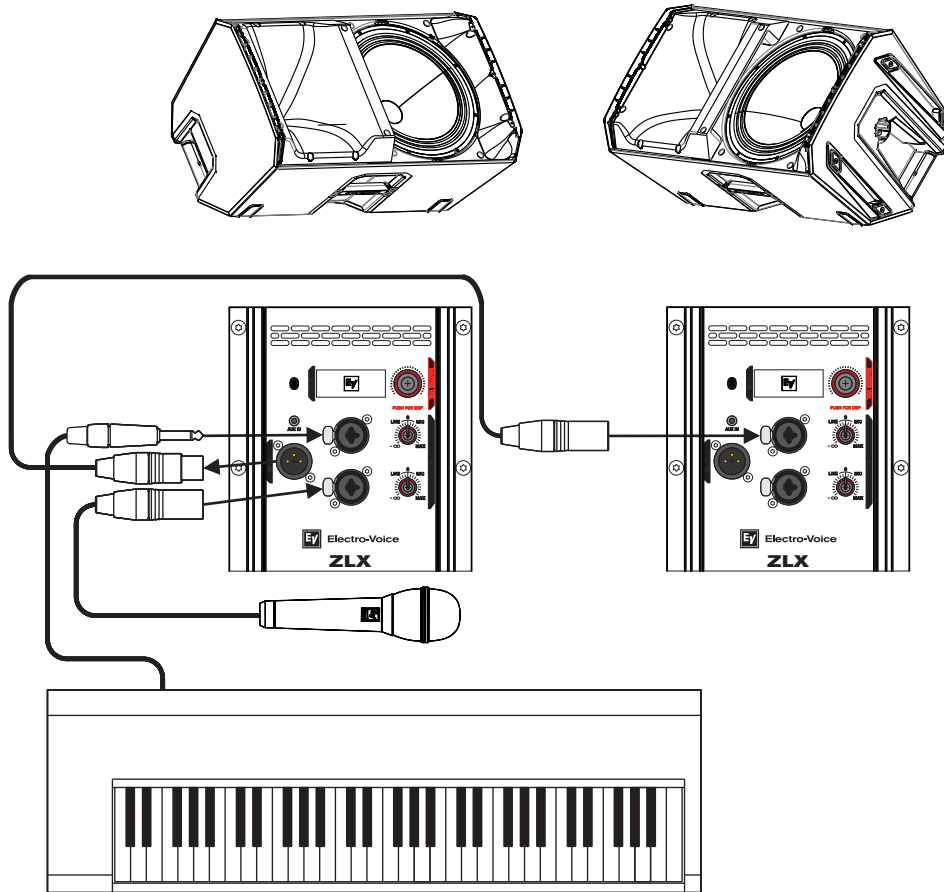

#### Notice!

The direction of the arrow indicates the signal path.

|                  |         |
|------------------|---------|
| <b>Mode:</b>     | Live    |
| <b>Location:</b> | Monitor |
| <b>Sub:</b>      | Off     |

**Tab. 5.4:** DSP settings loudspeakers as monitors

#### See also

- *Floor monitor, page 16*
- *Amplifier DSP, page 17*

### 5.1.4 Stacking full-range systems with subwoofers

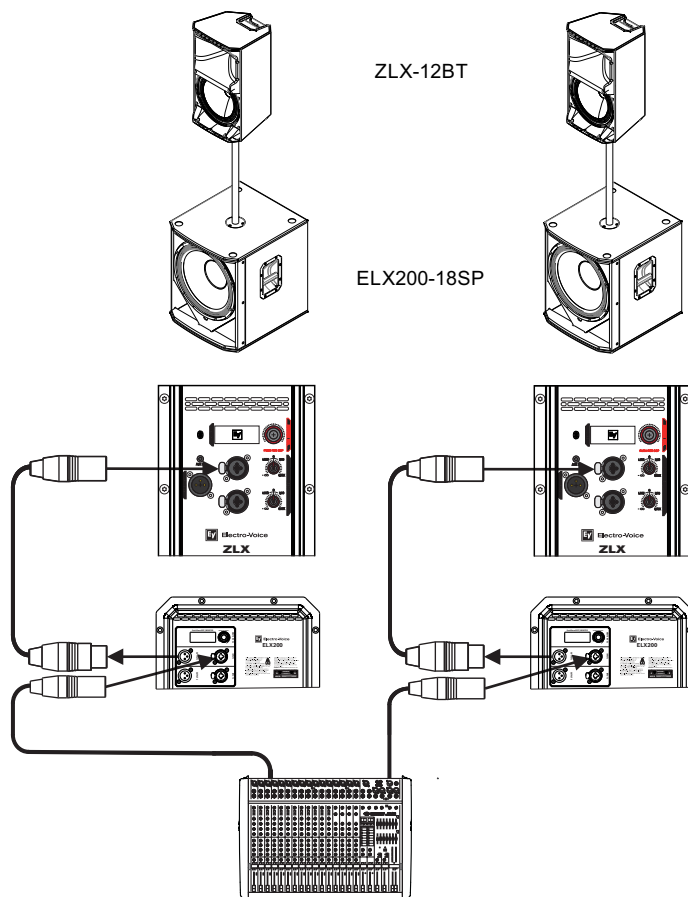

**Notice!**

The direction of the arrow indicates the signal path.

|                  |             |
|------------------|-------------|
| ZLX-12BT         |             |
| <b>Mode:</b>     | Live        |
| <b>Location:</b> | Pole        |
| <b>Sub:</b>      | ELX200-18SP |
| ELX200-18SP      |             |
| <b>Mode:</b>     | Live        |
| <b>Location:</b> | Pole        |
| <b>Low Pass:</b> | ZLX-12BT    |

**Tab. 5.5:** DSP settings loudspeaker and subwoofer stacked

**See also**

- *Tripod or pole mount, page 14*
- *Amplifier DSP, page 17*

### 5.1.5

#### Wireless audio STEREO configuration

Wireless audio streaming via Bluetooth® is available for ZLX-12BT and ZLX-15BT loudspeakers. *Bluetooth® is available in select countries.*

This configuration can be used to connect two speakers and split the incoming Bluetooth® signal to create a stereo image between two speakers.

Parameters and mobile device pairing is to be done on the LEFT speaker.

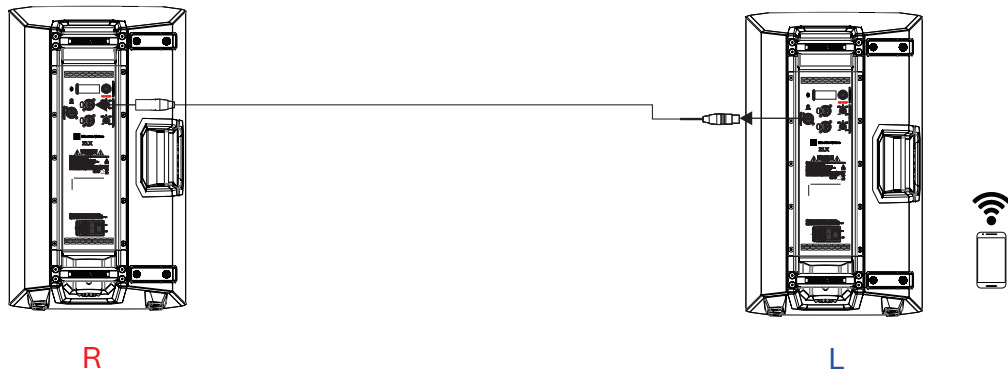

|   |       |
|---|-------|
| R | Right |
| L | Left  |



#### Notice!

The direction of the arrow indicates the signal path.

|                  |       |
|------------------|-------|
| <b>Mode:</b>     | Music |
| <b>Mix Out:</b>  | R     |
| <b>BT Audio:</b> | On    |

**Tab. 5.6:** DSP settings wireless audio streaming

#### See also

- *Amplifier DSP, page 17*

## 5.2 Passive loudspeakers

### 5.2.1 Basic stereo system using full-range systems

Basic stereo system using ZLX-12 or ZLX-15 systems (ZLX-15 versions shown).

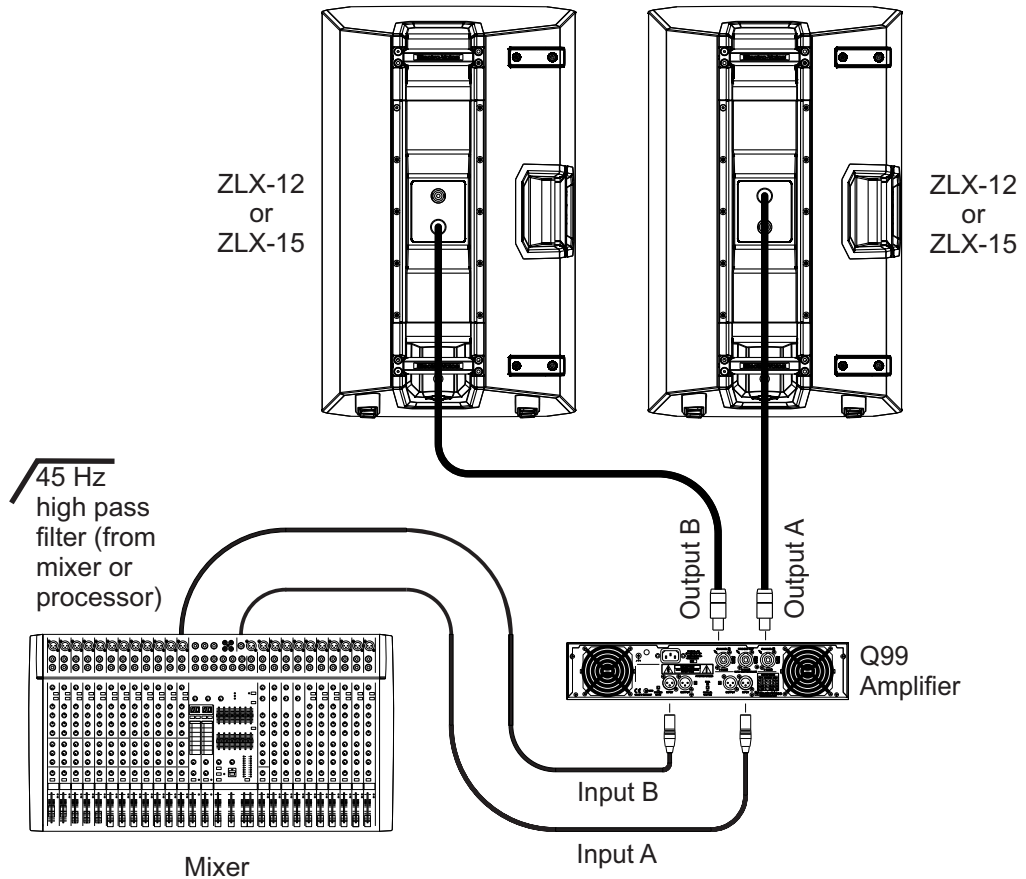

| NL4 Pin Configuration |          |
|-----------------------|----------|
| Pin 1+ and 1-         | Used     |
| Pin 2+ and 2-         | Not used |



**Caution!**

Do not exceed the maximum load rating of the amplifier.

| Amplifier Load (per Output Channel) |          |          |
|-------------------------------------|----------|----------|
| # of Speakers                       | Nominal  | Minimum  |
| 1                                   | 8 Ohms   | 7.2 Ohms |
| 2                                   | 4 Ohms   | 3.6 Ohms |
| 3                                   | 2.7 Ohms | 2.4 Ohms |
| 4                                   | 2 Ohms   | 1.8 Ohms |

### 5.2.2 Using full-range systems as stage monitors

Multiple ZLX-12 or ZLX-15 systems in monitor position (ZLX-15 versions shown).

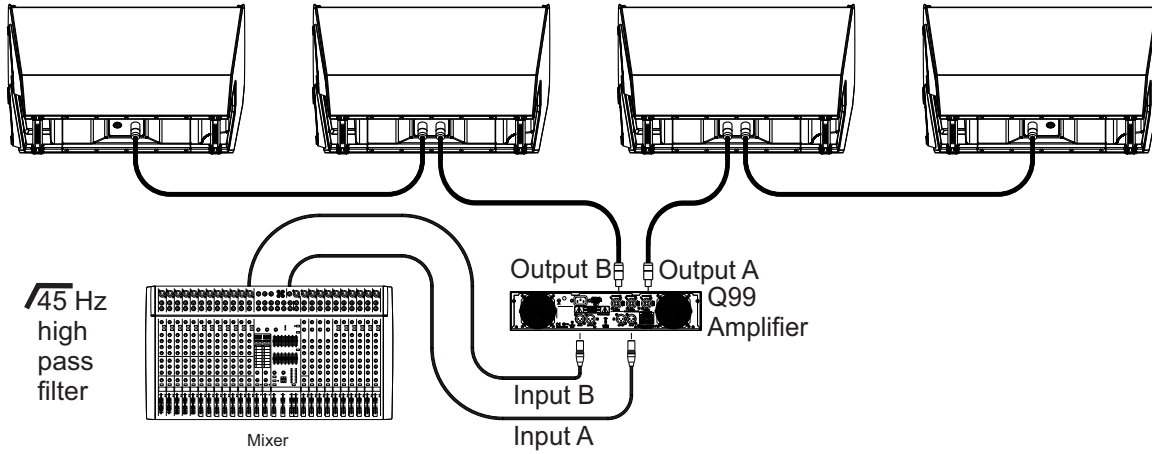

| NL4 Pin Configuration |          |
|-----------------------|----------|
| Pin 1+ and 1-         | Used     |
| Pin 2+ and 2-         | Not used |



**Caution!**

Do not exceed the maximum load rating of the amplifier.

| Amplifier Load (per Output Channel) |          |          |
|-------------------------------------|----------|----------|
| # of Speakers                       | Nominal  | Minimum  |
| 1                                   | 8 Ohms   | 7.2 Ohms |
| 2                                   | 4 Ohms   | 3.6 Ohms |
| 3                                   | 2.7 Ohms | 2.4 Ohms |
| 4                                   | 2 Ohms   | 1.8 Ohms |



### 5.2.3

### Stacking full-range systems with subwoofers

This configuration allows a user to increase the low frequency performance without using additional amplifier channels (ZLX-15 and EKX-18S versions shown).

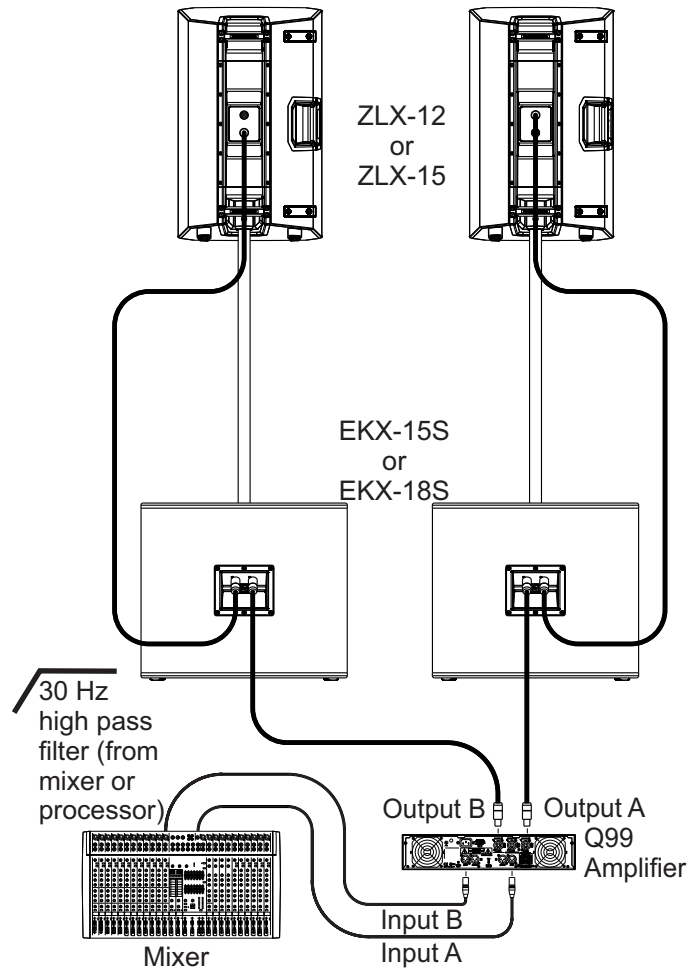

| NL4 Pin Configuration |          |
|-----------------------|----------|
| Pin 1+ and 1-         | Used     |
| Pin 2+ and 2-         | Not used |



**Caution!**

Do not exceed the maximum load rating of the amplifier.

| Amplifier Load (per Output Channel)    |         |          |
|--|---------|----------|
| # of Subwoofer/Full-Range Combinations | Nominal | Minimum  |
| 1                                      | 4 Ohms  | 3.8 Ohms |
| 2                                      | 2 Ohms  | 1.9 Ohms |

## 6 Troubleshooting

| Problem  | Possible Cause(s)                            | Action  |
|--|--|---|
| 1. No sound  | Amplifier                                    | Verify all the electronics are on, the signal routing is correct, the source is active; the volume is turned up, etc.<br>Correct/repair/replace as necessary. If there is still no sound, then the problem may be wiring.   |
|  | Wiring                                       | Verify you have connected the correct cables to the amplifier. Play something at a low level through the amplifier. Connect a test loudspeaker in parallel with the malfunctioning line. If the sound level is gone or is very weak, the line has a short in it (possibly a severe scrape, pinch, or a missed connection). Using the test loudspeaker, move down the line and test each connection/junction until you find the problem and correct it. Observe proper polarity. |
| 2. Poor Low-Frequency Response                                       | With SUB menu cross-over frequency activated | If no subwoofers are used with the system, select the OFF position.   |
| 3. Intermittent output such as cracking or distortion                | Faulty connection                            | Check all connections at amplifier and loudspeakers to ensure they are all clean and tight. If the problem persists, check the wiring. See problem 1.   |
| 4. Constant noise such as buzzing, hissing or humming                | Defective source or other electronic device  | If noise is present, but no program material is playing, evaluate each component as necessary to isolate the problem. Most likely there is a break in the signal path.  |
|  | Poor system grounding or ground loop         | Check and correct the system grounding, as required.  |
|  | Input gain knob is not in the MIC position   | Slowly increase the input gain knob level to engage the microphone pre-amp.   |
| 5. No sound produced with microphone connected to INPUT 1 or INPUT 2 | Microphone requires phantom power.           | Use a dynamic microphone that does not require phantom power. If using a microphone requiring phantom power, an external phantom power source is needed.  |
|  | Input gain knob is not in the MIC position   | Slowly increase the input gain knob level to engage the microphone pre-amp.   |
| 6. Sound is distorted front LED is OFF, LCD screen LIMIT is ON       | Excessive input level                        | Reduce the input level or loudspeaker level knobs to prevent limit.   |

| Problem  | Possible Cause(s)  | Action   |
|--|--|--|
|  | Incorrect gain structure or source input (mixing console/preamp) is overdriven       | Verify level controls of the source are properly structured by using the VU meter indicator on the LCD screen. If the VU meter bar is solid or the system indicates LIMIT, the input or source level is too high.  |
| 7. Microphone produces acoustic feedback when input level is amplified | Incorrect gain structure   | Reduce the microphone levels at the mixing console or input source. If the microphone is connected directly to the speaker, reduce the input level on the speaker. Positioning the microphone close to the sound source increases gain-before-feedback. See problem 6.   |
|  | MODE is set to MUSIC   | Change the MODE to LIVE or SPEECH.   |
|  | Microphone position is too close to the front of the loudspeaker                     | Whenever possible setup the loudspeakers so the microphone is behind them. If using the loudspeaker in a monitor position, aim the loudspeaker to the back of the microphone.  |
| 8. DSP menu is locked  | The Menu Lock function has been turned on. A lock symbol displays on the LCD screen. | Press and hold the MASTER VOL knob for 5 seconds.  |
| 9. No streaming audio  | STREAMING is set to OFF  | Set STREAMING to PAIRING and initiate the Bluetooth® pairing process on your mobile device.  |
|  | Mobile device is paired to the wrong speaker.  | If you have previously paired to a different Bluetooth® enabled ZLX loudspeaker, you may be pairing with the wrong device. Try deleting all saved connections labeled <i>EV ZLX BT</i> and try the pairing process again.  |
|  | Input level is too low   | While music is playing, turn up the volume on the paired mobile device. You will see the BT VU Meter receiving signal. Reduce if you see a CLIP notification.  |
|  | Output Gain is too low   | Increase output gain by setting your LEVEL with the MASTER VOL knob, paying attention to CLIP and LIMIT notifications.   |
| 10. Skipping or stuttering playback with streaming audio               | Paired mobile device is too far away from the loudspeaker                            | Move the mobile device closer to the loudspeaker.  |
|  | High amount of interference in the use area.   | This Bluetooth® enabled loudspeaker occupies the same operating frequencies as other Bluetooth® devices, as well as Wi-Fi and other wireless transmissions (like wireless home phones). If you are experiencing drop-outs, your speaker may be in an environment that makes reliable wireless audio difficult. Try to move the loudspeaker to different locations in the room, and |

| Problem | Possible Cause(s) | Action   |
|---------|-------------------|--|
|         |                   | especially away from 2.4GHz routers and microphone receivers. If the problem persists, revert back to a wired connection while at that particular venue. |

If these suggestions do not solve your problem, contact your nearest Electro-Voice dealer or Electro-Voice distributor.

**See also**

- *Amplifier DSP, page 17*

## 7 Technical data

### Powered loudspeakers

#### ZLX-12BT

|   |   |
|---|---|
| Frequency response (-3 dB) <sup>1</sup> : | 65 Hz - 18 kHz  |
| Frequency range (-10 dB):                 | 50 Hz - 20 kHz  |
| Maximum SPL <sup>2</sup> :                | 126 dB  |
| Coverage (H x V):                         | 90° x 60°   |
| Power rating:                             | 1000 W  |
| LF Transducer:                            | EVS-12K, 300 mm (12 in) woofer                                  |
| HF Transducer:                            | DH-1K   |
| Connectors:                               | (2) XLR/TRS combo jack (1) 3.5 mm input and (1) XLR link output |
| Enclosure:                                | Polypropylene   |
| Grille:                                   | 18 Gauge steel with black powder coat                           |
| Color:                                    | Black   |
| Dimensions (H x W x D):                   | 610 mm x 356 mm x 356 mm<br>(24 in x 14 in x 14 in )            |
| Net weight:                               | 15.6 kg (34.3 lb)   |
| Shipping weight:                          | 19.0 kg (41.8 lb)   |
| Power consumption <sup>3</sup> :          | 100 - 240 V~, 50 - 60 Hz, 0.8 - 0.5 A                           |

<sup>1</sup>Full-Space measurement using the MUSIC DSP preset.

<sup>2</sup>Maximum SPL is measured at 1 m using broadband pink noise at maximum output.

<sup>3</sup>Current rating is specified at 1/8 full output power.

#### ZLX-15BT

|   |   |
|---|---|
| Frequency response (-3 dB) <sup>1</sup> : | 55 Hz - 18 kHz  |
| Frequency range (-10 dB):                 | 42 Hz - 20 kHz  |
| Maximum SPL <sup>2</sup> :                | 127 dB  |
| Coverage (H x V):                         | 90° x 60°   |
| Power rating:                             | 1000 W  |
| LF Transducer:                            | EVS-15L, 380 mm (15 in) woofer                                  |
| HF Transducer:                            | DH-1K   |
| Connectors:                               | (2) XLR/TRS combo jack (1) 3.5 mm input and (1) XLR link output |
| Enclosure:                                | Polypropylene   |
| Grille:                                   | 18 Gauge steel with black powder coat                           |

|                                  |  |
|----------------------------------|--|
| Color:                           | Black  |
| Dimensions (H x W x D):          | 685 mm x 426 mm x 383 mm<br>(27 in x 17 in x 15 in ) |
| Net weight:                      | 17.3 kg (38.0 lb)                                    |
| Shipping weight:                 | 23.0 kg (50.78 lb)                                   |
| Power consumption <sup>3</sup> : | 100 - 240 V~, 50 - 60 Hz, 0.8 - 0.5 A                |

<sup>1</sup>Full-Space measurement using the MUSIC DSP preset.

<sup>2</sup>Maximum SPL is measured at 1 m using broadband pink noise at maximum output.

<sup>3</sup>Current rating is specified at 1/8 full output power.

### ZLX-12P

|   |  |
|---|--|
| Frequency response (-3 dB) <sup>1</sup> : | 65 Hz - 18 kHz   |
| Frequency range (-10 dB):                 | 50 Hz - 20 kHz   |
| Maximum SPL <sup>2</sup> :                | 126 dB   |
| Coverage (H x V):                         | 90° x 60°  |
| Power rating:                             | 1000 Watts   |
| LF Transducer:                            | EVS-12K, 300 mm (12 in) woofer                                   |
| HF Transducer:                            | DH-1K  |
| Connectors:                               | (2) XLR/TRS combo jack (1) 3.5 mm input, and (1) XLR link output |
| Enclosure:                                | Polypropylene  |
| Grille:                                   | 18 Gauge steel with black powder coat                            |
| Color:                                    | Black  |
| Dimensions (H x W x D):                   | 610 mm x 356 mm x 356 mm<br>(24 in x 14 in x 14 in)              |
| Net weight:                               | 15.6 kg (34.3 lb)  |
| Shipping weight:                          | 19.0 kg (41.8 lb)  |
| Power consumption <sup>3</sup> :          | 100 - 240 V~, 50 - 60 Hz, 0.8 - 0.5 A                            |

<sup>1</sup>Full-Space measurement using the MUSIC DSP preset.

<sup>2</sup>Maximum SPL is measured at 1 m using broadband pink noise at maximum output.

<sup>3</sup>Current rating is specified at 1/8 full output power.

### ZLX-15P

|   |                |
|---|----------------|
| Frequency response (-3 dB) <sup>1</sup> : | 55 Hz - 18 kHz |
| Frequency range (-10 dB):                 | 42 Hz - 20 kHz |
| Maximum SPL <sup>2</sup> :                | 127 dB         |
| Coverage (H x V):                         | 90° x 60°      |

|                                  |   |
|----------------------------------|---|
| Power rating:                    | 1000 W  |
| LF Transducer:                   | EVS-15L, 380 mm (15 in) woofer                                  |
| HF Transducer:                   | DH-1K   |
| Connectors:                      | (2) XLR/TRS combo jack (1) 3.5 mm input and (1) XLR link output |
| Enclosure:                       | Polypropylene   |
| Grille:                          | 18 Gauge steel with black powder coat                           |
| Color:                           | Black   |
| Dimensions (H x W x D):          | 685 mm x 423 mm x 383 mm<br>(27 in x 17 in x 15 in)             |
| Net weight:                      | 17.3 kg (38.0 lb)   |
| Shipping weight:                 | 23.0 kg (50.7 lb)   |
| Power consumption <sup>3</sup> : | 100 - 240 V~, 50 - 60 Hz, 0.8 - 0.5 A                           |

### Passive loudspeakers

#### ZLX-12

|   |  |
|---|--|
| Frequency response (-3 dB) <sup>1</sup> : | 82-Hz - 18 KHz   |
| Frequency range (-10 dB):                 | 55 Hz - 20 kHz   |
| Axial sensitivity:                        | 95 dB  |
| Maximum SPL <sup>2</sup> :                | 125 dB   |
| Recommended High-Pass Freq.:              | 40 Hz  |
| Coverage (H x V):                         | 90° x 60°  |
| Power handling:                           | 250 W Continuous, 1000 W Peak                          |
| LF Transducer:                            | EVS-12K, 300 mm (12 in.) woofer                        |
| HF Transducer:                            | DH-1K  |
| Crossover Freq.:                          | 2.1 kHz  |
| Nominal impedance:                        | 8 Ω  |
| Minimum impedance:                        | 7 Ω  |
| Connectors:                               | Dual NL4   |
| Enclosure:                                | Polypropylene  |
| Grille:                                   | 18 gauge steel with black powder coat                  |
| Color:                                    | Black  |
| Dimensions (H x W x D):                   | 610 mm x 356 mm x 356 mm<br>(24 in. x 14 in. x 14 in.) |
| Net weight:                               | 14.9 kg (32.8 lb)                                      |

|                  |                   |
|------------------|-------------------|
| Shipping weight: | 18.0 kg (39.6 lb) |
|------------------|-------------------|

<sup>1</sup>Full Space Measurement, will have low frequency extension when mounted on floor or wall.

<sup>2</sup>Maximum SPL is measured at 1 m using broadband pink noise at maximum output.

### ZLX-15

|   |  |
|---|--|
| Frequency response (-3 dB) <sup>1</sup> : | 56 Hz - 18 KHz   |
| Frequency range (-10 dB):                 | 44 Hz - 20 kHz   |
| Axial sensitivity:                        | 96 dB  |
| Maximum SPL <sup>2</sup> :                | 126 dB   |
| Recommended High-Pass Freq.:              | 40 Hz  |
| Coverage (H x V):                         | 90° x 60°  |
| Power handling:                           | 250 W Continuous, 1000 W Peak                          |
| LF Transducer:                            | EVS-15L, 380 mm (15 in.) woofer                        |
| HF Transducer:                            | DH-1K  |
| Crossover Freq.:                          | 1.7 kHz  |
| Nominal impedance:                        | 8 Ω  |
| Minimum impedance:                        | 7 Ω  |
| Connectors:                               | Dual NL4   |
| Enclosure:                                | Polypropylene  |
| Grille:                                   | 18 gauge steel with black powder coat                  |
| Color:                                    | Black  |
| Dimensions (H x W x D):                   | 685 mm x 423 mm x 383 mm<br>(27 in. x 17 in. x 15 in.) |
| Net weight:                               | 16.6 kg (36.5 lb)                                      |
| Shipping weight:                          | 22.0 kg (48.3 lb)                                      |

<sup>1</sup>Full Space Measurement, will have low frequency extension when mounted on floor or wall.

<sup>2</sup>Maximum SPL is measured at 1 m using broadband pink noise at maximum output.



## 7.1 Dimensions

Powered version shown.

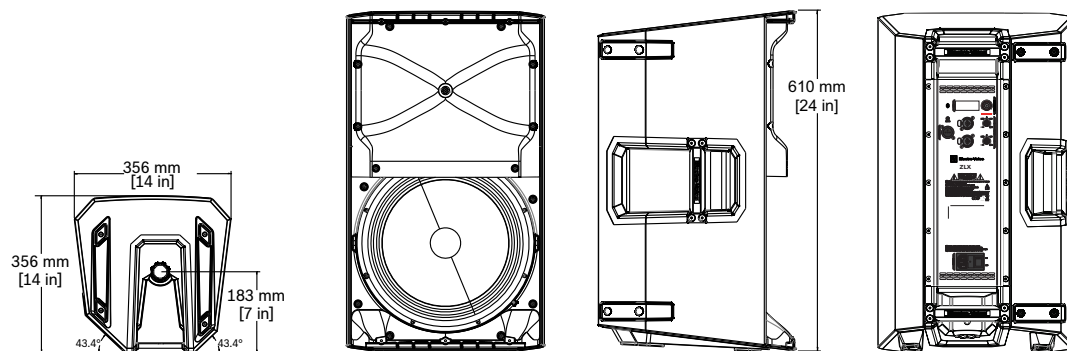

Figure 7.1: Dimensions: 12" ZLX models

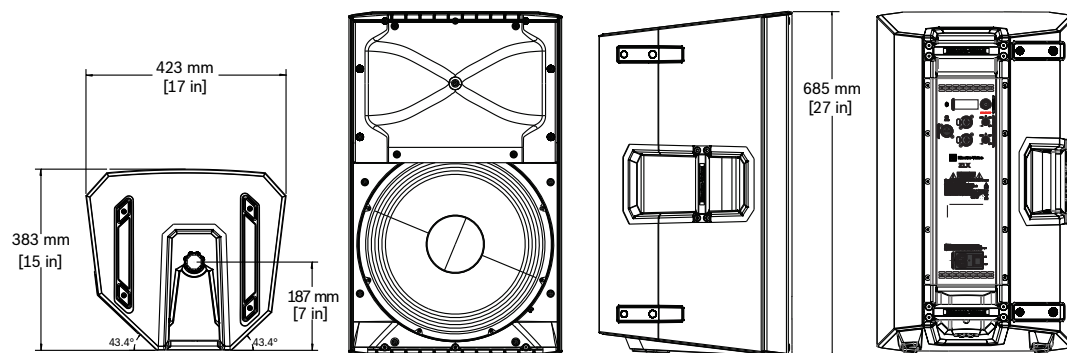

Figure 7.2: Dimensions: 15" ZLX models

## 7.2 Frequency response

### Powered loudspeakers

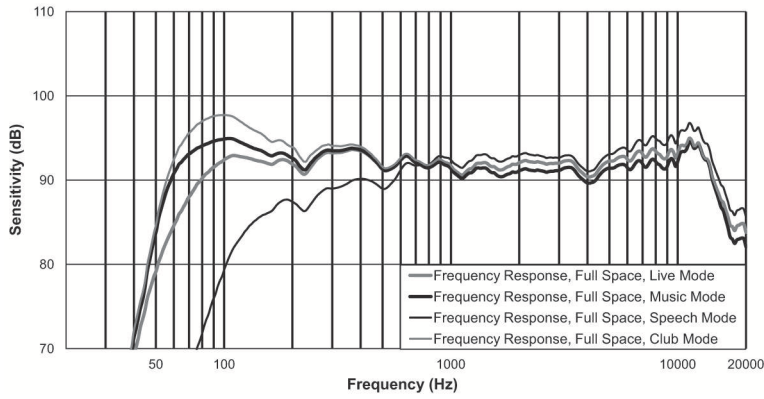

Figure 7.3: Frequency response: 12" powered ZLX models

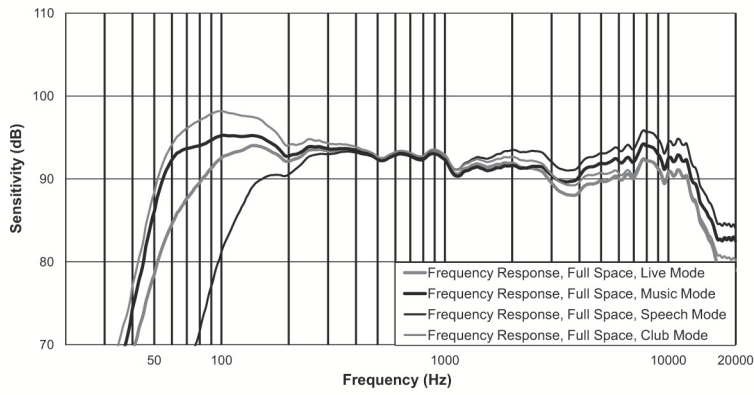

Figure 7.4: Frequency response: 15" powered ZLX models

### Passive loudspeakers

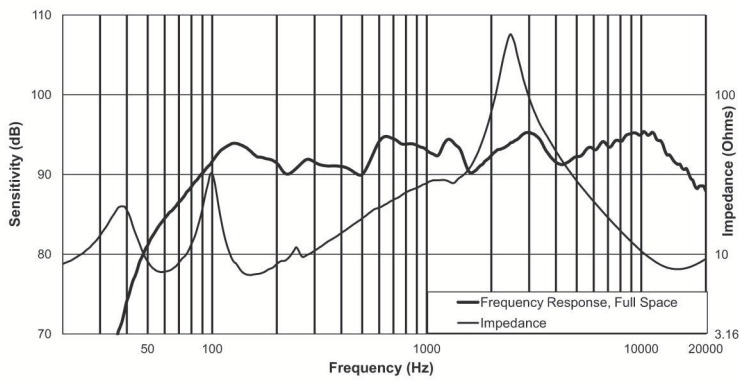

Figure 7.5: Frequency response: 12" passive models

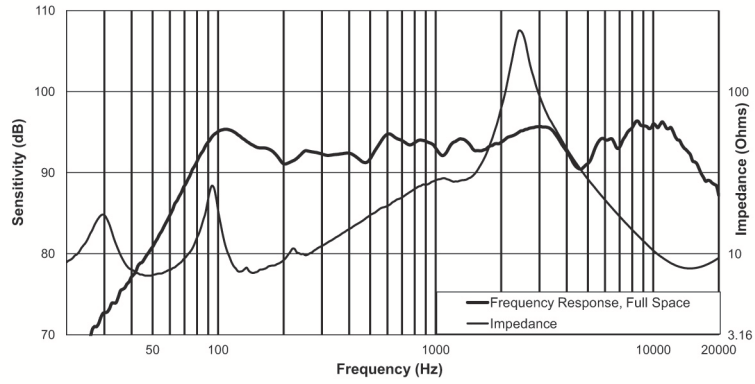
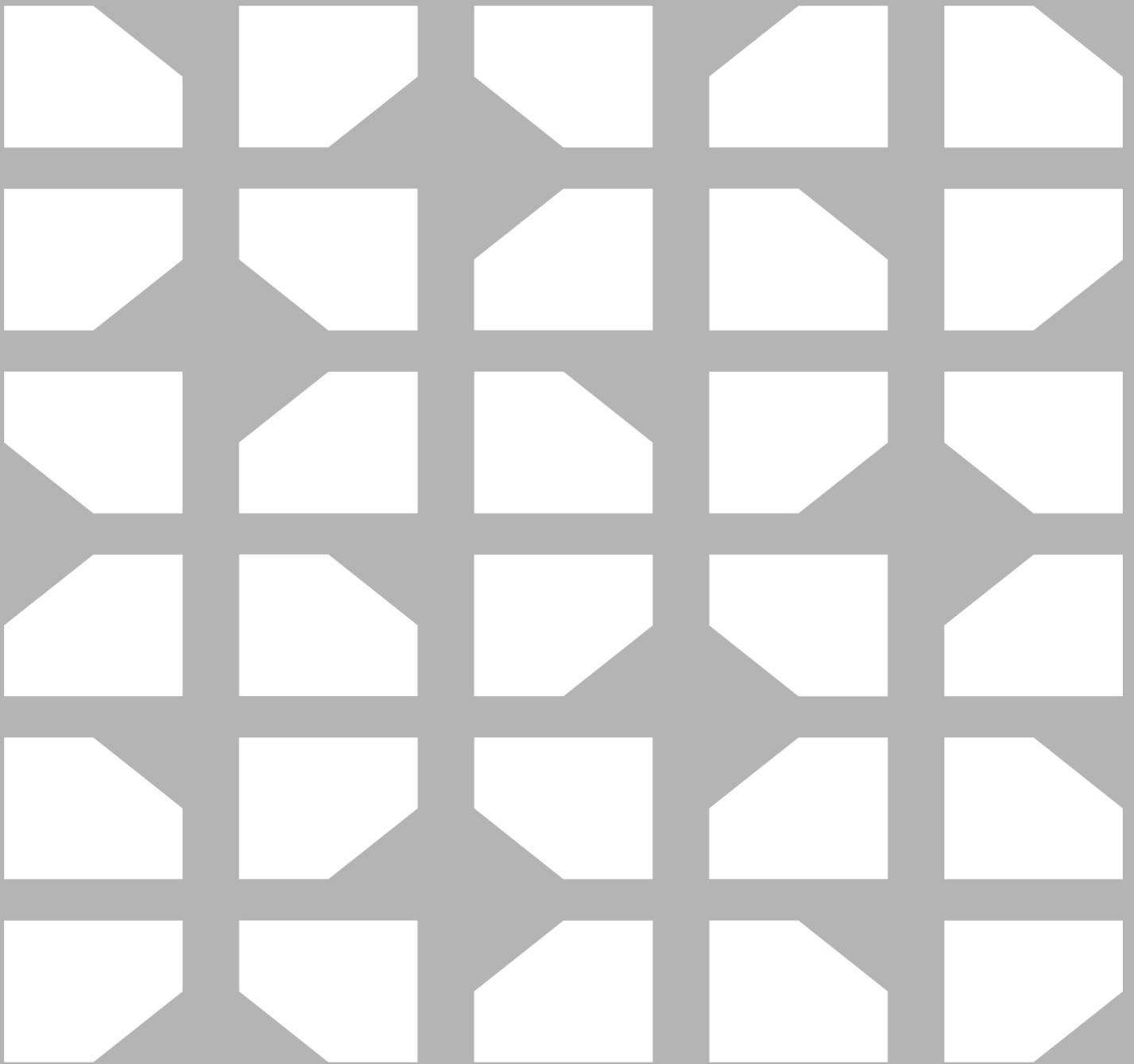

Figure 7.6: Frequency response: 15" passive models



**Bosch Sicherheitssysteme GmbH**

Robert-Bosch-Ring 5  
85630 Grasbrunn  
Germany

**[www.boschsecurity.com](http://www.boschsecurity.com)**

© Bosch Sicherheitssysteme GmbH, 2019

**Bosch Security Systems, Inc**

12000 Portland Avenue South  
Burnsville MN 55337  
USA

**[www.electrovoice.com](http://www.electrovoice.com)**

© Bosch Security Systems, Inc., 2019