



DN9680 8-port AES50 Extender

User Manual



Contents

1. Introduction	4
1.1 Key features	4
1.2 About this manual	4
2. Getting Started	5
2.1 Unpacking	5
2.2 Installation	5
2.3 Connecting up	5
2.4 Powering the unit on/off	5
2.5 Configuration	5
3. Front panel	6
4. Rear panel	6
5. Connections	7
6. Configuring The DN9680	8
7. About The LCD Display	8
8. Technical Specifications	9
9. Service Information	9
9.1 Routine maintenance	9
9.2 Cleaning the unit	9
9.3 Cleaning the optical connectors	9
9.4 Replacing the mains fuse	9
9.5 Equipment disposal	9

EN Important Safety Instructions

Terminals marked with this symbol carry electrical current of sufficient magnitude to constitute risk of electric shock.

Use only high-quality commercially-available speaker cables with ¼" TS plugs pre-installed. All other installation or modification should be performed only by qualified personnel.



This symbol, wherever it appears, alerts you to the presence of uninsulated dangerous voltage inside the enclosure - voltage that may be sufficient to constitute a risk of shock.



This symbol, wherever it appears, alerts you to important operating and maintenance instructions in the accompanying literature. Please read the manual.

**Caution**

To reduce the risk of electric shock, do not remove the top cover (or the rear section). No user serviceable parts inside. Refer servicing to qualified personnel.

**Caution**

To reduce the risk of fire or electric shock, do not expose this appliance to rain and moisture. The apparatus shall not be exposed to dripping or splashing liquids and no objects filled with liquids, such as vases, shall be placed on the apparatus.

**Caution**

These service instructions are for use by qualified service personnel only. To reduce the risk of electric shock do not perform any servicing other than that contained in the operation instructions. Repairs have to be performed by qualified service personnel.

1. Read these instructions.
2. Keep these instructions.
3. Heed all warnings.
4. Follow all instructions.
5. Do not use this apparatus near water.
6. Clean only with dry cloth.
7. Do not block any ventilation openings. Install in accordance with the manufacturer's instructions.

8. Do not install near any heat sources such as radiators, heat registers, stoves, or other apparatus (including amplifiers) that produce heat.
9. Do not defeat the safety purpose of the polarized or grounding-type plug. A polarized plug has two blades with one wider than the other. A grounding-type plug has two blades and a third grounding prong. The wide blade or the third prong are provided for your safety. If the provided plug does not fit into your outlet, consult an electrician for replacement of the obsolete outlet.
10. Protect the power cord from being walked on or pinched particularly at plugs, convenience receptacles, and the point where they exit from the apparatus.

11. Use only attachments/accessories specified by the manufacturer.



combination to avoid injury from tip-over.

13. Unplug this apparatus during lightning storms or when unused for long periods of time.

14. Refer all servicing to qualified service personnel. Servicing is required when the apparatus has been damaged in any way, such as power supply cord or plug is damaged, liquid has been spilled or objects have fallen into the apparatus, the apparatus has been exposed to rain or moisture, does not operate normally, or has been dropped.

15. The apparatus shall be connected to a MAINS socket outlet with a protective earthing connection.

16. Where the MAINS plug or an appliance coupler is used as the disconnect device, the disconnect device shall remain readily operable.

**LEGAL DISCLAIMER**

TECHNICAL SPECIFICATIONS AND APPEARANCES ARE SUBJECT TO CHANGE WITHOUT NOTICE AND ACCURACY IS NOT GUARANTEED. MIDAS AND KLARK TEKNIK ARE PART OF THE MUSIC GROUP (MUSIC-GROUP.COM). ALL TRADEMARKS ARE THE PROPERTY OF THEIR RESPECTIVE OWNERS. MUSIC GROUP ACCEPTS NO LIABILITY FOR ANY LOSS WHICH MAY BE SUFFERED BY ANY PERSON WHO RELIES EITHER WHOLLY OR IN PART UPON ANY DESCRIPTION, PHOTOGRAPH

OR STATEMENT CONTAINED HEREIN. COLOURS AND SPECIFICATIONS MAY VARY SLIGHTLY FROM PRODUCT. MIDAS PRODUCTS ARE SOLD THROUGH AUTHORIZED DEALERS ONLY. DISTRIBUTORS AND DEALERS ARE NOT AGENTS OF MUSIC GROUP AND HAVE ABSOLUTELY NO AUTHORITY TO BIND MUSIC GROUP BY ANY EXPRESS OR IMPLIED UNDERTAKING OR REPRESENTATION. THIS MANUAL IS COPYRIGHTED. NO PART OF THIS MANUAL MAY BE REPRODUCED OR TRANSMITTED IN ANY FORM OR BY ANY MEANS, ELECTRONIC OR MECHANICAL, INCLUDING PHOTOCOPYING AND RECORDING OF ANY KIND, FOR ANY PURPOSE, WITHOUT THE EXPRESS WRITTEN PERMISSION OF MUSIC GROUP IP LIMITED.

ALL RIGHTS RESERVED.

© 2013 MUSIC Group IP Ltd.

Trident Chambers, Wickhams Cay, P.O. Box 146, Road Town, Tortola, British Virgin Islands

LIMITED WARRANTY

For the applicable warranty terms and conditions and additional information regarding MUSIC Group's Limited Warranty, please see complete details online at www.music-group.com/warranty.

DN9680 8-port AES50 Extender

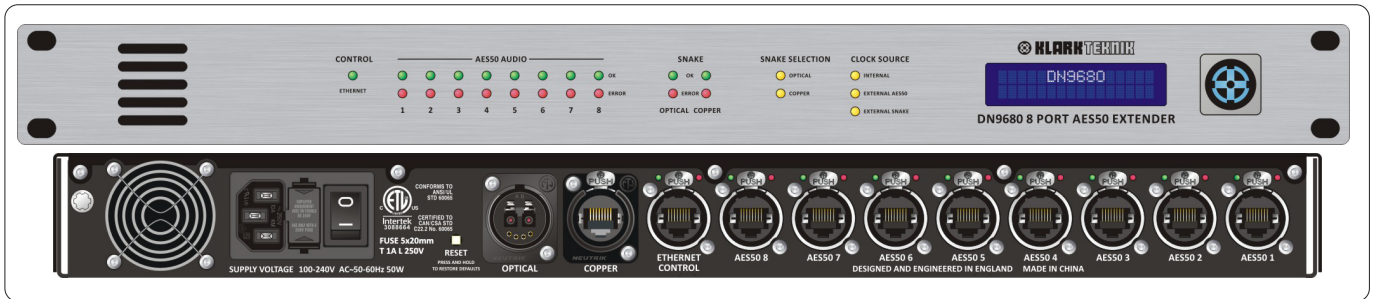

1. Introduction

Welcome!

Thank you for purchasing a KLARK TEKNIK DN9680 8-port AES50 Extender.

The DN9680 is an 8-port AES50 extender designed to take up to eight AES50 connections, convert them to HyperMAC for transport over distances of up to one kilometre and then convert them back to AES50 on a port-for-port basis.

The DN9680, which is housed in a 1U, 19" rack mount unit, transports up to 192 digital audio signals at 96kHz, bi-directionally over distances of up to 1 km on a single mode 1300nm laser. The unit includes simple port-to-port routing and optional internal clock generation. The AES50 input format is suitable for products in the Midas digital console range and future AES50-enabled Behringer digital consoles.

Two DN9680s are required in a typical system set-up, each one being configured via a simple utility that is based on hypertext transfer protocol (http) and accessed through an Ethernet control port.

The DN9680 was conceived by KLARK TEKNIK to offer audio professionals high performance audio equipment, designed to provide no-compromise sonic quality with a feature set that offers all essential facilities and functions. It represents the very best of British design and engineering combined with contemporary, efficient manufacturing methods, and will give you many years of reliable service.

So, to obtain the best results with a minimum of effort, please read this manual and, finally, enjoy your KLARK TEKNIK DN9680 8-port AES50 Extender!

1.1 Key features

The DN9680 has the following key features:

- 8 x AES50 etherCON® input ports.
- Each AES50 port carries 24 channels of 96kHz digital audio plus control data.
- AES50 is converted to HyperMAC for transport over a snake to another DN9680, which converts signals back to AES50 on port-for-port basis.
- Option of optical fibre (up to 1 km) or copper snake (up to 100 m) via an opticalCON® port or etherCON port, respectively.
- Ethernet control port for unit configuration (IP address, sample rate, clock options, etc.) via on-board web-based application.
- LCD display.
- Unit is transparent when connected to console (cannot be detected), so that any device connected at an AES50 port will have its signalling information (port info., redundancy info., diagnostics, discovery, etc.) mirrored at the other DN9680.
- 96kHz sample rate.
- Three clock options: internal; external AES50; and external snake.

- Mains input is a switch mode power supply (SMPS) with on/off switch and fuse drawer for easy fuse replacement.
- Internal fan.
- Reset button for resetting the unit to its factory default condition.

1.2 About this manual

This is the user manual for the DN9680 8-port AES50 Extender. It is intended to help get your unit installed and in operation as quickly as possible by giving you unpacking, installation, connection, setting up and operating instructions. To help familiarise you with the DN9680 there is a description of the front and rear panels and maintenance instructions to ensure your DN9680 gives you optimum performance.

2. Getting Started

This section shows you how to unpack, install, connect up, power up and configure the DN9680 unit.

- ◆ This equipment is supplied by a mains voltage that can cause electric shock injury.
- ◆ This equipment is supplied with a fibre optic connection system. Beware of laser radiation. Do not stare into the beam!
- ◆ Before installing, setting up or operating this equipment, make sure that you have read and fully understand all of this section and the "Important safety instructions" at the front of this manual.

2.1 Unpacking

Carefully unpack your DN9680 equipment package.

Then, inspect the DN9680 unit carefully for any signs of damage that may have occurred during transit and notify the courier immediately if you discover any.

Check the contents of your DN9680 equipment package. If there are any parts missing, incorrect or faulty, please contact your local distributor or Midas at the address at the front of this manual.

Please retain the original packing in case you should need to return the equipment to the manufacturer or supplier, or transport or ship the unit later.

2.2 Installation

Before installing and operating this equipment, make sure it is correctly connected to the protective earth conductor of the mains voltage supply socket outlet through the mains lead.

Do not install the equipment in places of poor ventilation.

Do not install this equipment in a location subjected to excessive heat, dust or mechanical vibration. Allow for adequate ventilation around the equipment, making sure that its fans and vents are not obstructed. Whenever possible, keep the equipment out of direct sunlight.

Mount in rack only.

Power

- ◆ The supply cord must be unplugged to ensure complete de-energisation of the unit.

The internal power supply is of the switch mode type that automatically senses the incoming mains voltage and will work where the nominal voltage is in the range 110V AC to 230V AC.

A mains inlet is provided on the rear panel. The correct lead for connection in the area to which the unit was shipped is supplied with the unit. The equipment should only be plugged into the mains outlet using the supplied lead.

Handling the equipment

When lifting or moving the equipment, always take its size and weight into consideration.

Completely isolate the equipment electrically and disconnect all cables from the equipment before moving it.

Do not insert your fingers or hands in any gaps or openings on the equipment, for example, vents.

Electric fields

In accordance with Part 15 of the FCC Rules & Regulations, "... changes or modifications not expressly approved by the party responsible for compliance could void the user's authority to operate the equipment."

Should this product be used in an electromagnetic field that is amplitude modulated by an audio frequency signal (20 Hz to 20 kHz), the signal to noise ratio may be degraded. Degradation of up to 60dB at a frequency corresponding to the modulation signal may be experienced under extreme conditions (3 V/m, 90% modulation).

2.3 Connecting up

Connect up the units as required:

- AES50 cables from AES50-equipped device (for example, console) to first DN9680.
- Optical/copper snake from first DN9680 to second DN9680.
- AES50 from second DN9680 to other AES50-equipped device (for example, I/O unit).
- Mains power IEC connectors to both DN9680s.

2.4 Powering the unit on/off

Switch on the mains on/off switch of both DN9680s (rear panel). The blue roundel on the front panel of the unit should illuminate to show that power is on.

2.5 Configuration

Configure the DN9680s to suit the system parameters (for example, clock source, sample rate frequency, etc.). For details, see "6. Configuring The DN9680 " on page 8.

3. Front panel

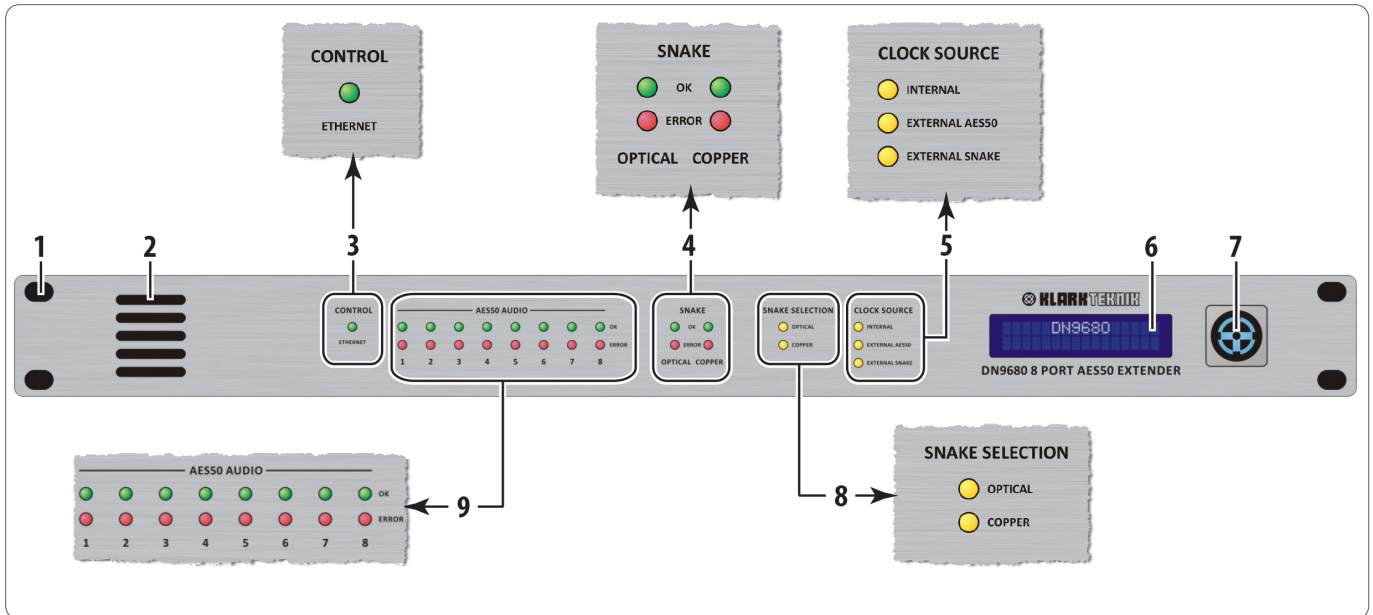

- (1) Four cut outs for rack mounting.
- (2) Ventilation grill. **Do not obstruct.**
- (3) Ethernet control status LED. Shows the current activity on the **ETHERNET CONTROL** port, where: off = not connected; on = connected; and flashing = active communications.
- (4) Snake status LEDs. Show the status of the connected snake, where **OK** pulsates when link is synchronised between router and end point, and **ERROR** illuminates to show no valid connection or a fault.
- (5) Shows the currently selected clock source, where: **INTERNAL** = the DN9680's internally generated clock is used; **EXTERNAL AES50** = the DN9680 automatically searches the AES50 ports for the first valid clock; and **EXTERNAL SNAKE** = the clock on the snake connection is used.
- (6) LCD display, which has 32 characters in a 16 x 2 configuration.
- (7) Backlit Klark Teknik roundel, which illuminates light blue to show that the unit is powered up.
- (8) Shows the currently selected snake type.
- (9) AES50 audio status LEDs show the status of each AES50 port, where **OK** pulsates to show good communication and **ERROR** illuminates to communication error.

4. Rear panel

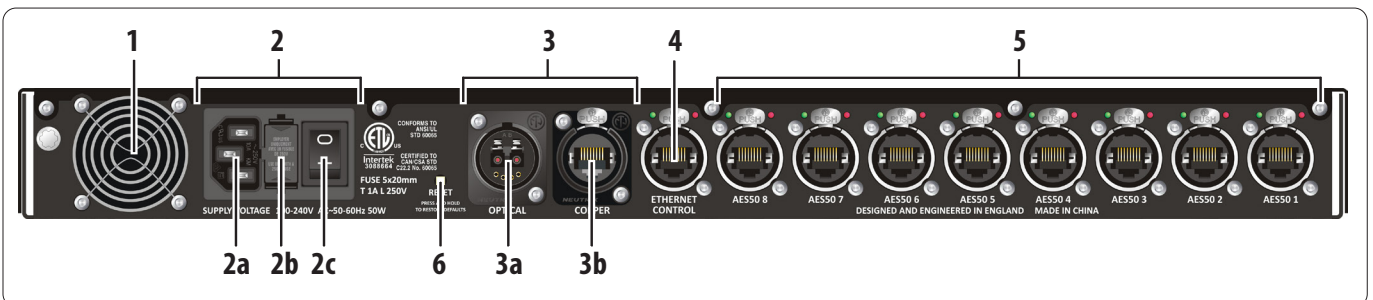

- (1) Ventilation grill. **Do not obstruct.**
- (2) Mains power inlet. This is a switch mode power supply that has a mains IEC socket (2a), power on/off switch (2c) and a fuse drawer (2b) that houses an easily replaceable mains fuse.
- (3) Snake connectors for connecting the two DN9680s together via a single optical (3a) or Cat 6 (3b) snake.
- (4) Ethernet control port for connecting a PC/Mac for configuring the unit.
- (5) Eight AES50 connectors.
- (6) Reset button for resetting the unit to its factory default condition.

5. Connections



Caution: Laser radiation; do not stare into beam!

To ensure the correct and reliable operation of the equipment, only high quality balanced, screened, twisted pair audio cable should be used.

XLR connector shells should be of metal construction so that they provide a screen when connected and, where appropriate, they should have Pin 1 connected to the cable screen.

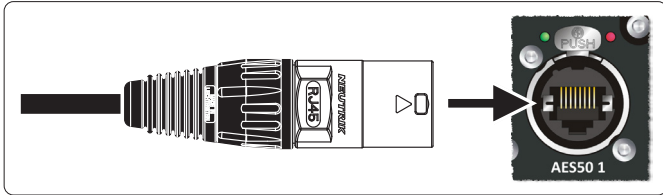

AES50 etherCON connector

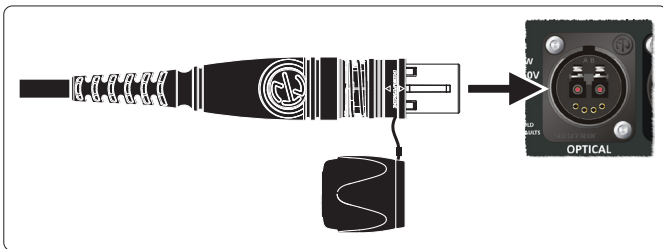

DN9680 snake - optical etherCON connector option to **OPTICAL** socket

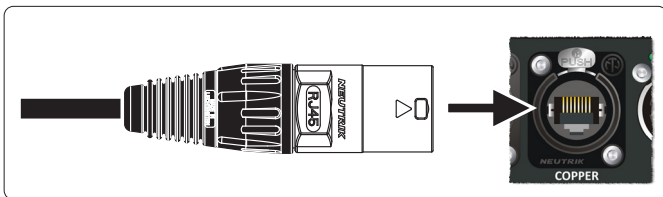

DN9680 snake - copper etherCON connector option to **COPPER** socket

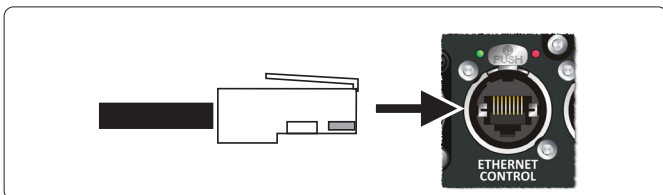

PC/Mac RJ45 connector to **ETHERNET CONTROL** socket

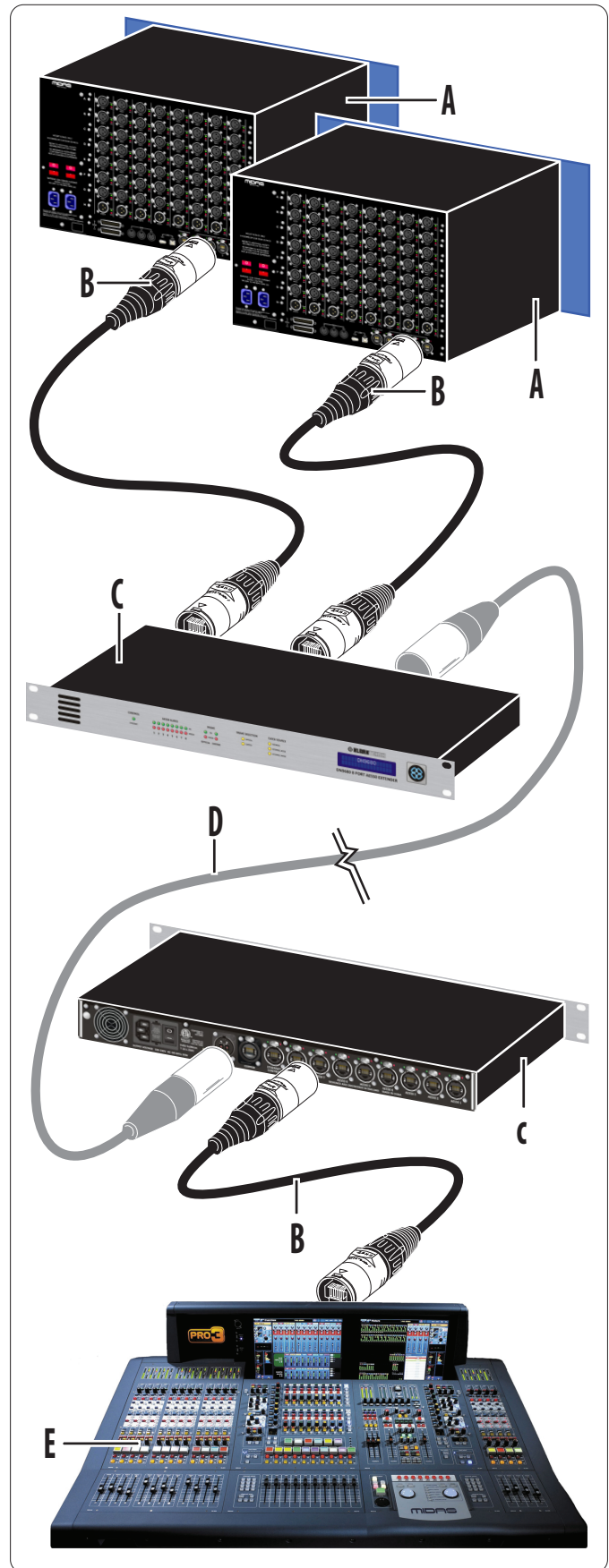

Typical connection diagram.

A. Two DL351 modular I/O units. **B.** Up to 100m AES50 cables (console to DN9680). **C.** DN9680 units. **D.** DN9680 snake (option of optical or copper). **E.** Digital console (for example, PRO3).

6. Configuring The DN9680

To configure a DN9680, connect your PC/Mac to the **ETHERNET CONTROL** socket on the unit's rear panel.

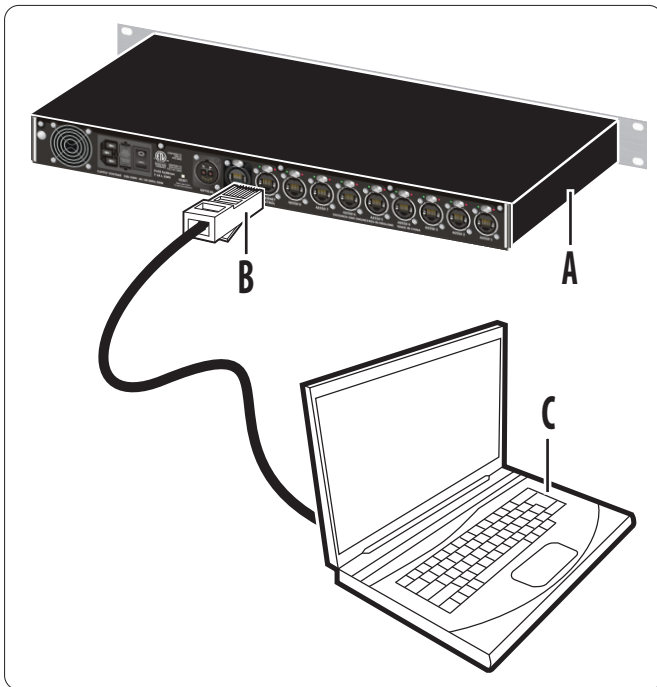

Connecting your PC/Mac to the DN9680 for unit configuration. **A.** DN9680 unit. **B.** RJ45 Ethernet connector (connect to the DN9680's **ETHERNET CONTROL** socket). **C.** PC/Mac.

Then open the browser on your PC/Mac; the DN9680's onboard web page will open, and the unit can be configured as required. Start by entering the default IP address as shown on the front of the box.

When configuring the IP address, your PC/Mac must be set up to have a 16-bit netmask (255.255.0.0). All DN9680 units on the network **MUST** have a unique IP address.

DN9680 Configuration Screen

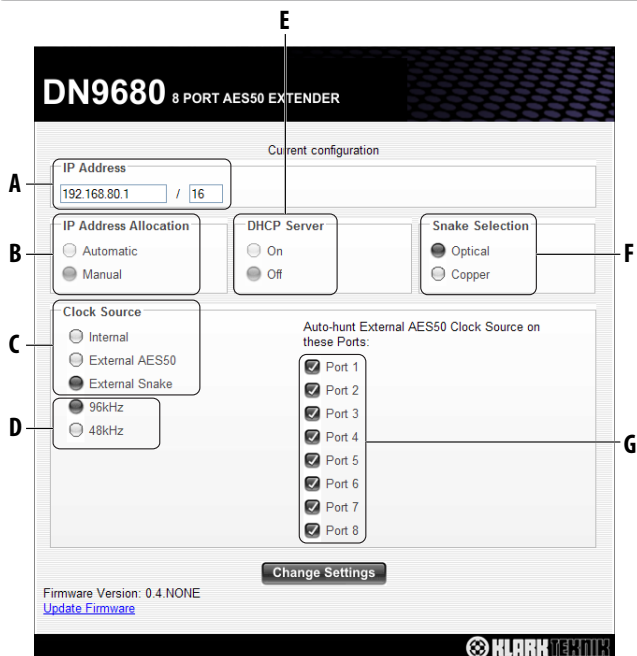

A. IP address **B.** IP address allocation **C.** Clock source **D.** 48kHz/96kHz selection **E.** DHCP Server **F.** Snake selection **G.** Port auto-hunt selection

7. About The LCD Display

The LCD display comprises two rows of 16 digits. The top row displays the current IP address of the unit. The eight characters to the bottom left of the display will be reserved for displaying remote report information. The eight characters to the bottom right will show system synchronisation information.

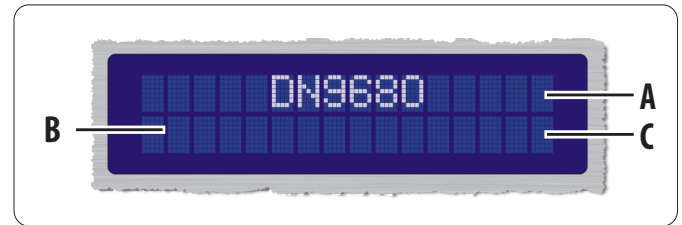

Default display. **A.** Current IP address. **B.** Software version number and Remote Report information. **C.** System Synchronisation information.

DN9680 Remote Report Information

x	No cable is currently connected
D	There is a valid data link, typically on the inactive side of the XL8
A	There is currently a good audio link

DN9680 System Synchronisation Information

F<n>	Displayed on the clock master when it has synchronised to a fixed AES50 port n
G<n>	Displayed on the clock slave when the remote master has a good synchronisation to a fixed AES50 port n
H<n>	Displayed on the clock master when hunting is trying to synchronise to port n
N<n>	Displayed on the clock when the master is not synchronised to fixed port AES50 port n
NS	Displayed on the clock slave when it is not synchronised to the external snake
R<n>	Displayed on the clock slave when the remote master has hunted successfully and synchronised to port n
RI	Displayed on the clock slave when the remote master is using synchronisation from its internal clock source
S<n>	Displayed on the clock master when it has hunted successfully and synchronised to port n
SI	Displayed on the clock master when it is using synchronisation from its internal clock source
SS	Displayed on the clock slave when it is synchronised to the external snake
T<n>	Displayed on the clock slave when the master clock has hunted successfully to the target AES50 port n and synchronised to it
X<n>	Displayed on the clock slave when the clock master has not successfully synchronised to a target AES50 port n
RM	Displayed on the clock slave when there has been a remote mismatch

8. Technical Specifications

© 2013 MUSIC Group IP Ltd. Technical specifications and appearances are subject to change without notice and accuracy is not guaranteed. MIDAS and KLARK TEKNIK are part of the MUSIC Group (music-group.com).

DN9680 general specifications

Dimensions	1U high (44.5 mm (1.75")), 482.0 mm (19") wide, 410.0 mm (16.1") deep
Net weight	4.9 kg
Shipping weight	6.9 kg
Power consumption	50W
Power requirement	100-240V~, 50-60Hz
Operating temperature range	+5°C to 45°C
Storage temperature range	-20°C to +60°C

Inputs and outputs

Audio	8 x AES50 etherCON ports with integral status LEDs
Snake (options)	1 x copper HyperMAC port (cable can be up to 100 m long) 1 x optical HyperMAC port (cable can be up to 1000 m long)
Unit configuration port	1 x Ethernet control port for RJ45 connector
Mains power inlet	3-pin IEC connector

9. Service Information

This section gives you servicing information for your unit.

If you are in any doubt or have queries about any of the procedures in this section, contact Midas Technical Support. Contact details can be found at the front of this manual.

9.1 Routine maintenance

To help keep your unit in good working order and to make sure it gives you optimum performance, we recommend that you carry out the following every month.

- Clean the unit (see "9.2 Cleaning the unit").
- Check the functionality of the LCD display, LEDs and the power on/off indicator.
- Check the functionality of the equipment.
- Clean the optical chassis connector and also, if necessary, the optical snake connectors (see "9.3 Cleaning the optical connectors").

9.2 Cleaning the unit

- ♦ Switch off the unit and electrically isolate it from the mains before cleaning.

Clean the unit using a dry, lint-free cloth. Don't use harsh abrasives or solvents.

9.3 Cleaning the optical connectors

- ♦ Before cleaning the optical chassis connector on the rear panel of the DN9680, electrically isolate the unit by switching it off and removing the

mains cable from the rear of the unit.

- ♦ Before cleaning an optical connector on the snake, disconnect the snake at both ends for safety reasons. Invisible laser radiation may be emitted from disconnected fibres or connectors. Do not stare into the beams or view directly with optical instruments.

To clean an optical connector on the rear of the DN9680 or on the snake, see the "HANDLING INSTRUCTION, opticalCON/Fiber Optic Connection System", which is downloadable from the Neutrik website at "<http://www.neutrik.co.uk/zoolu-website/media/download/163/opticalCON+Handling+Instruction>".

9.4 Replacing the mains fuse

- ♦ Switch off the power to the unit and electrically isolate it from the mains before replacing the mains fuse.

To replace the mains fuse, carry out the following (see Figure 1):

- 1) Switch off the power to the DN9680 unit at the mains power outlet.
- 2) Remove the mains IEC connector from the rear of the unit.
- 3) Pull out the fuse drawer and remove the faulty fuse.
- 4) Fit a new fuse, ensuring it conforms to the correct rating and specification.

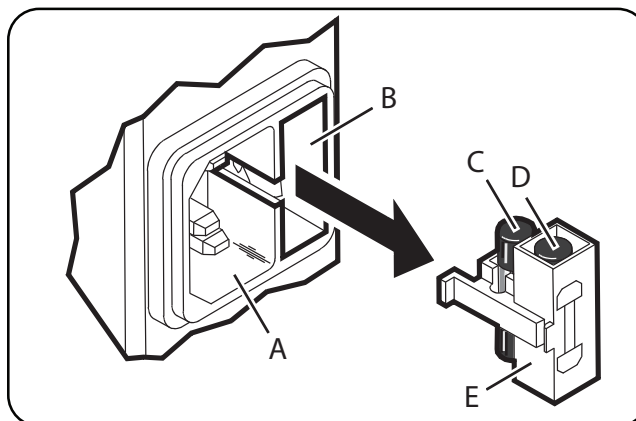

- 5) Fit the fuse drawer back into its compartment.

Mains fuse compartment on rear panel.

A. Mains IEC socket. B. Fuse compartment. C. Spare fuse. D. Mains fuse. E. Fuse holder.

9.5 Equipment disposal

When this equipment has come to the end of its useful life, its disposal may come under the DIRECTIVE 2002/96/EC OF THE EUROPEAN PARLIAMENT AND OF THE COUNCIL of 27 January 2003 on waste electrical and electronic equipment (WEEE).

Hazardous substances in WEEE contaminate water, soil and air and ultimately put at risk our environment and health. The directive aims to minimize the impacts of WEEE on the environment during their life times and when they become waste.

The WEEE directive addresses the disposal of products when they have reached the end of their life and contributes to the reduction of wasteful consumption of natural resources. This will help to reduce pollution, and protect the environment and ourselves.



If this equipment carries a 'crossed-out wheeled bin' (shown left), please do not dispose of WEEE as unsorted municipal waste but collect and dispose of in accordance with local WEEE legislation. The horizontal bar underneath indicates that the product was placed on the EU market after 13th August 2005. For WEEE disposal, see our website at klarkteknik.com for information.

Other important information

EN Important information

1. Register online. Please register your new Midas equipment right after you purchase it by visiting midasconsoles.com. Registering your purchase using our simple online form helps us to process your repair claims more quickly and efficiently. Also, read the terms and conditions of our warranty, if applicable.

2. Malfunction. Should your MUSIC Group Authorized Reseller not be located in your vicinity, you may contact the MUSIC Group Authorized Fulfiller for your country at midasconsoles.com. If your country is not listed please contact the "United Kingdom (Midas/ KT main office)" located under "Service Service/Repairs" on the midasconsoles.com website. Alternatively, please submit the online warranty return form found under "Service Warranty Registration" on midasconsoles.com BEFORE returning the product. All enquires must be accompanied by the description of the problem and the serial number of the product. The warranty eligibility will be verified from the original sales receipt.

3. Power Connections. Before plugging the unit into a power socket, please make sure you are using the correct mains voltage for your particular model. Faulty fuses must be replaced with fuses of the same type and rating without exception.

FEDERAL COMMUNICATIONS COMMISSION COMPLIANCE INFORMATION



MUSIC Group Research UK Limited

DN9680

Responsible Party Name: **MUSIC Group Research
UK Limited**

Address: **Klark Industrial Park,
Walter Nash Road,
Kidderminster. Worcestershire.
DY11 7HJ. England.**

Phone/Fax No.: **Phone: +44 1562 741515
Fax: +44 1562 745371**

DN9680

complies with the FCC rules as mentioned in the following paragraph:

This equipment has been tested and found to comply with the limits for a Class A digital device, pursuant to Part 15 of the FCC Rules. These limits are designed to provide reasonable protection against harmful interference when the equipment is operated in a commercial environment. This equipment generates, uses, and can radiate radio frequency energy and, if not installed and used in accordance with the instruction manual, may cause harmful interference to radio communications. Operation of this equipment in a residential area is likely to cause harmful interference in which case the user will be required to correct the interference at his own expense.

Important information:

Changes or modifications to the equipment not expressly approved by MUSIC Group can void the user's authority to use the equipment.



Klark Industrial Park, Walter Nash Road,
Kidderminster. Worcestershire. DY11 7HJ. England.
Tel: +44 1562 741515, Fax: +44 1562 745371
Email: mkt.info@music-group.com
Website: klarktechnik.com